

REVISIONS

ZONE	REV.	DESCRIPTION	DATE	APPR'D
	B-D	B Add Bushing plate 6500-123 1/14/15 DC, C Change 6500-120 Cap Plate to 6500-121 Alum 3-6-15 DC, D Add 2600-238 Cap Clamp, 3500-023 Capa, 4601-053 Fuse Assy, 2802-030 Heat sink, 2902-003 nut(2) 6/26/15		DC/D Q
	E	Added 9200-190 Resistor Kit UL325 to Note Block	3/16/16	DC
	F	Replace 6500-161 w/6500-162 Hub Ext Splined Replace 2600-717 with 2600-719 Gearbox, Remove 6500-146 Coupling, 2616-088 Set Screws and Keyways	5/11/16	DC
	G	Replaced 6500-453 Front Cover Assy w/6500-454 and Back 6500-463 w/6500-464, 6500-307 Bracket was 6500-284	1/29/19	DC

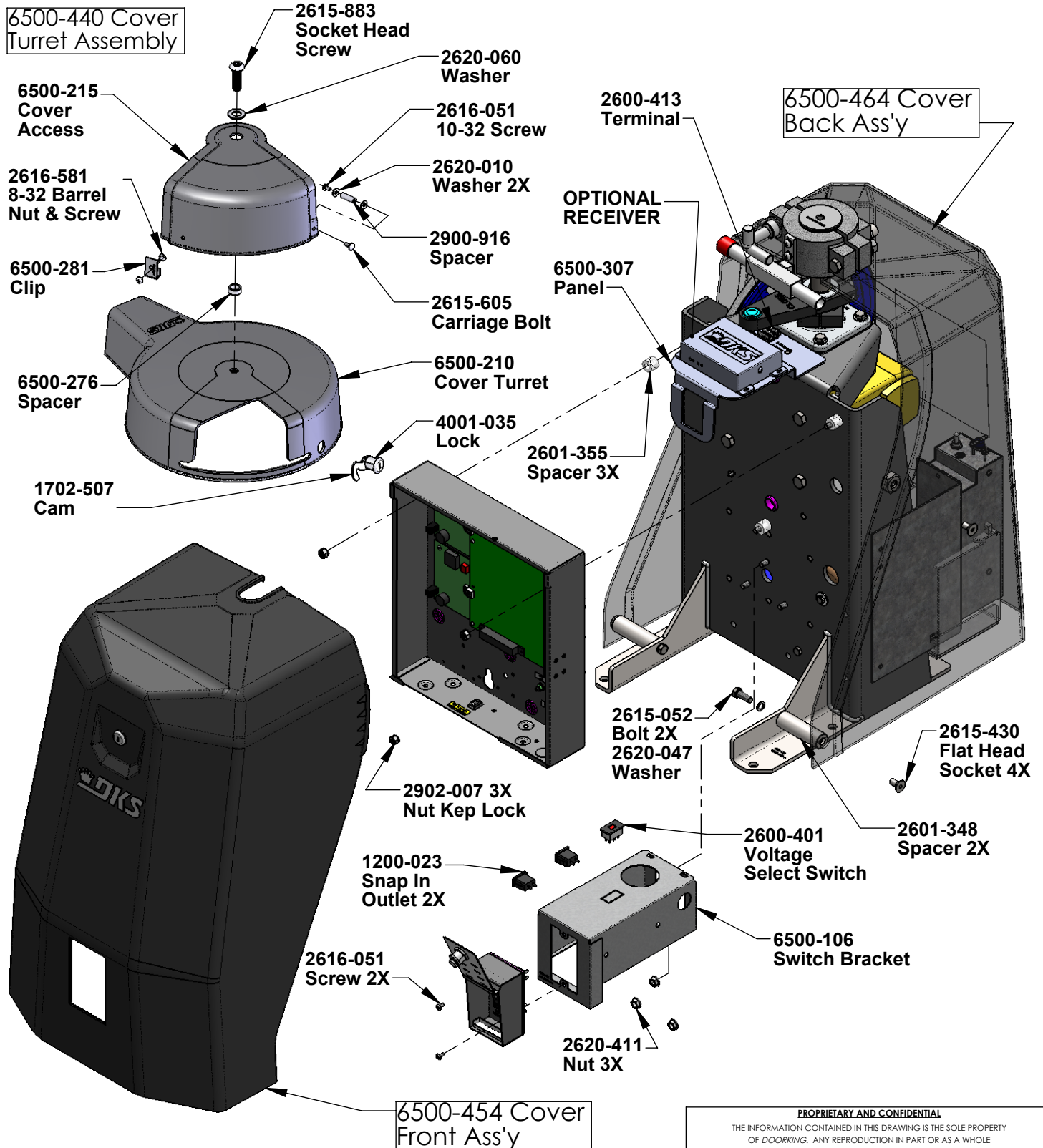

- 4.
3. Item 6500-066 Manual Installation Quick Install
2. Item 6500-065 Manual Installation Swing Gate
1. Item 7082-187 Wire Set
Included with Operator not Shown.

Notes: Unless Otherwise Specified.

PROPRIETARY AND CONFIDENTIAL

THE INFORMATION CONTAINED IN THIS DRAWING IS THE SOLE PROPERTY OF DOORKING. ANY REPRODUCTION IN PART OR AS A WHOLE WITHOUT THE WRITTEN PERMISSION OF DOORKING IS PROHIBITED.

www.doorking.com

IPB- Swing Gate Operator

SIZE	A	DWG. NO.	6524-380	REV.	G
		Scale: None			SHEET 1 OF 4

**6500-400
Hub Assy**

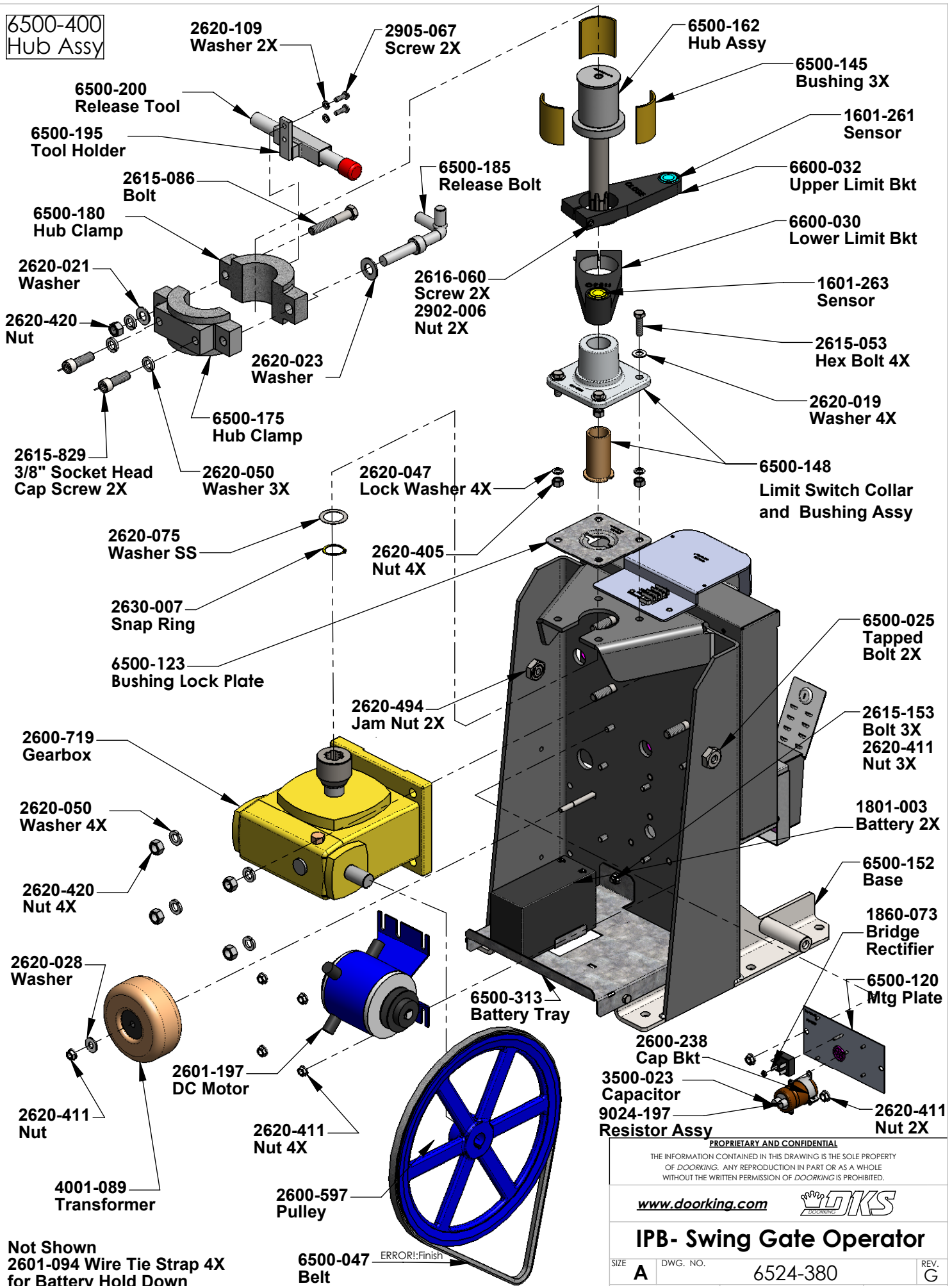

Not Shown
2601-094 Wire Tie Strap 4X
for Battery Hold Down

6500-047 ERROR! Finish
Belt

PROPRIETARY AND CONFIDENTIAL

THE INFORMATION CONTAINED IN THIS DRAWING IS THE SOLE PROPERTY OF DOORKING. ANY REPRODUCTION IN PART OR AS A WHOLE WITHOUT THE WRITTEN PERMISSION OF DOORKING IS PROHIBITED.

www.doorking.com

IPB- Swing Gate Operator

SIZE	DWG. NO.	REV.
A	6524-380	G
<small>Scale: None</small>		<small>SHEET 2 OF 4</small>

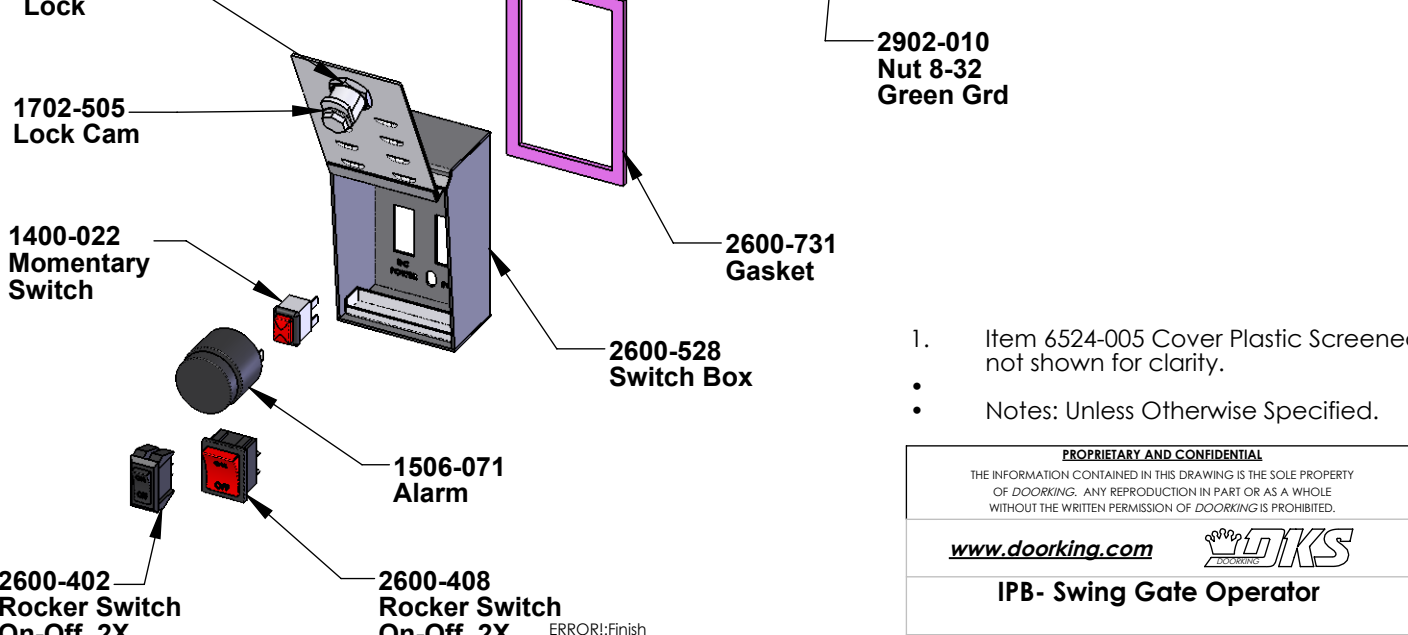
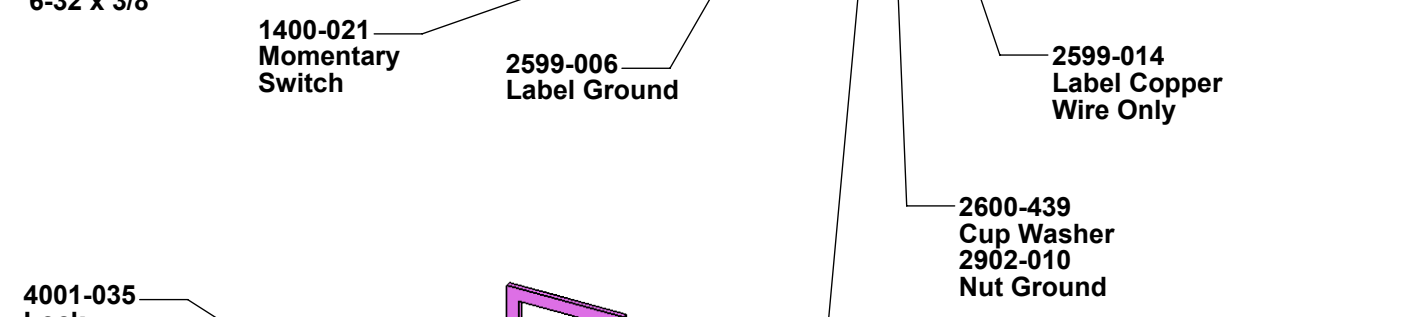
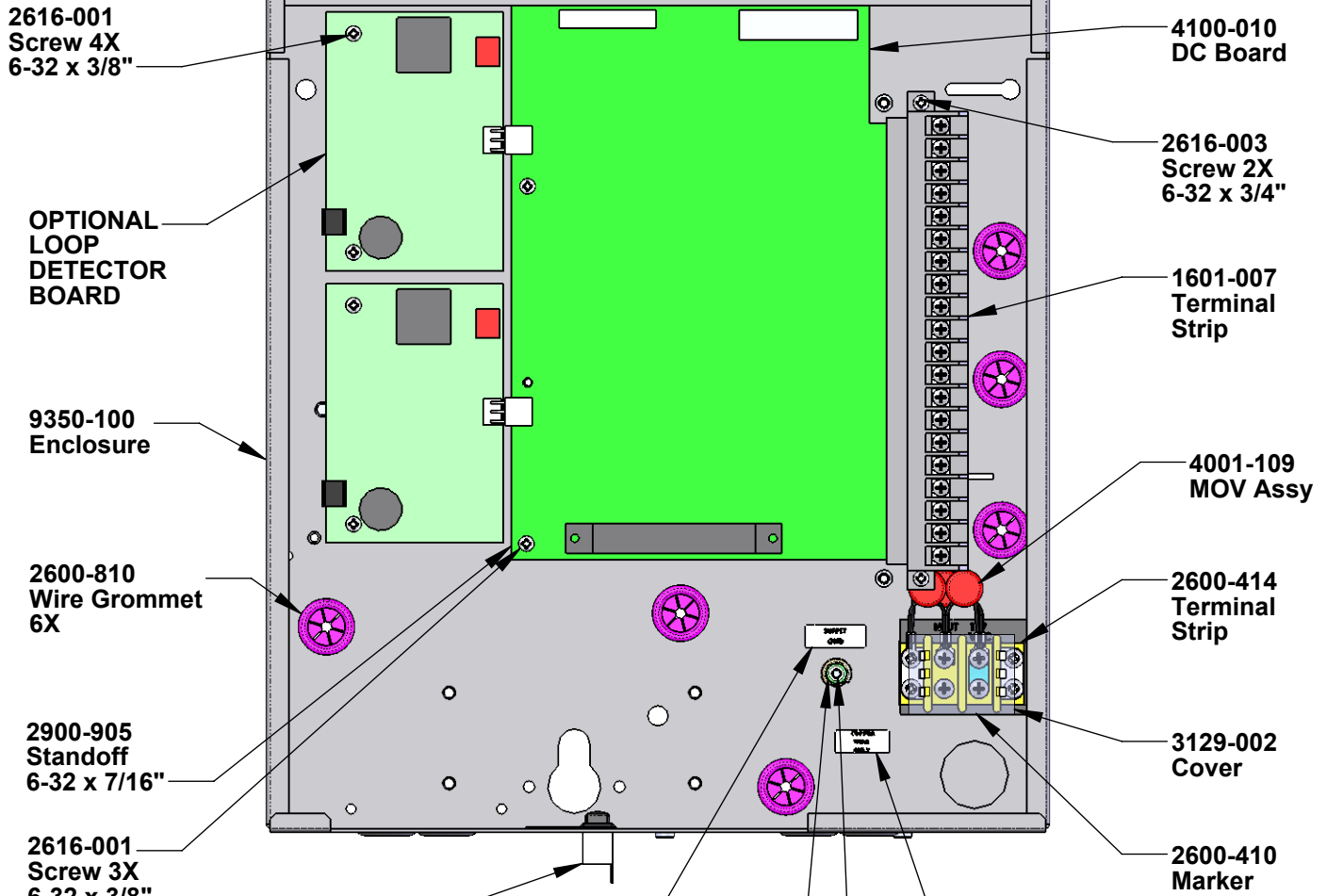

- Item 6524-005 Cover Plastic Screened not shown for clarity.
- Notes: Unless Otherwise Specified.

PROPRIETARY AND CONFIDENTIAL			
THE INFORMATION CONTAINED IN THIS DRAWING IS THE SOLE PROPERTY OF DOORKING. ANY REPRODUCTION IN PART OR AS A WHOLE WITHOUT THE WRITTEN PERMISSION OF DOORKING IS PROHIBITED.			
www.doorking.com			
IPB- Swing Gate Operator			
SIZE	DWG. NO.	REV.	
A	6524-380	G	
Scale: None		SHEET 3 OF 4	

ERROR! Finish

6500-430 Full
Assembly
Main Arm

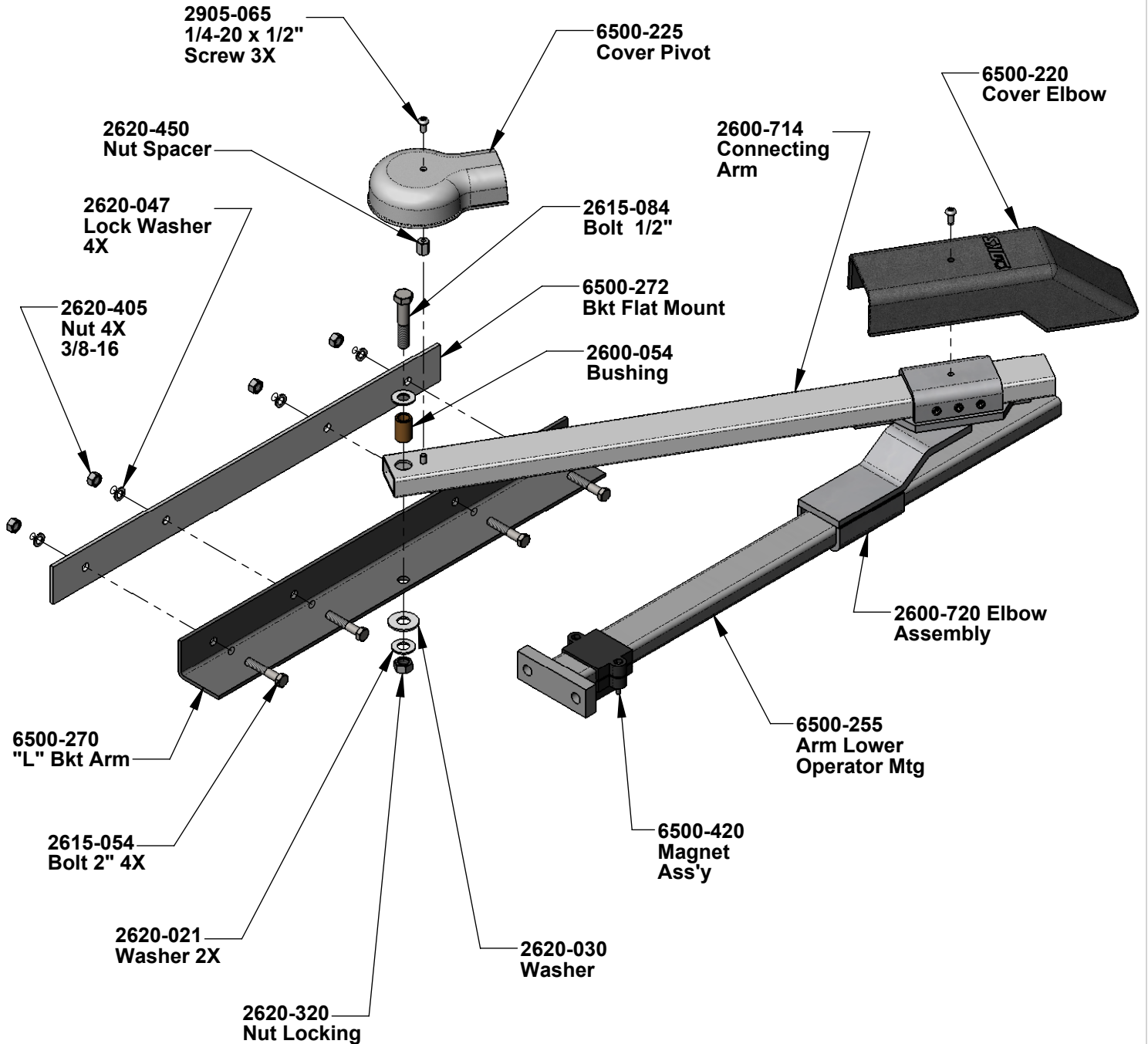

Notes: Unless Otherwise Specified.

ERROR!:Material

ERROR!:Finish

PROPRIETARY AND CONFIDENTIAL			
<small>THE INFORMATION CONTAINED IN THIS DRAWING IS THE SOLE PROPERTY OF DOOR KING. ANY REPRODUCTION IN PART OR AS A WHOLE WITHOUT THE WRITTEN PERMISSION OF DOOR KING IS PROHIBITED.</small>			
www.doorking.com			
IPB- Swing Gate Operator			
SIZE	DWG. NO.	REV.	
A	6524-380	G	
<small>Scale: None</small>			<small>SHEET 4 OF 4</small>