

# Wiring / Owner's Manual

# 4302 Solar Control Box for

6004, 6006 and 6400 gate operators

Use this manual for circuit board 4302-018 Revision A or higher.

4302-067-K-9-24

Entrapment Protection must be provided for the gate system where the risk of entrapment or obstruction exists. The operator will NOT run without one or more monitored type B1 or B2 entrapment protection devices in EACH entrapment area.

## UL 325 August 2018 Standard

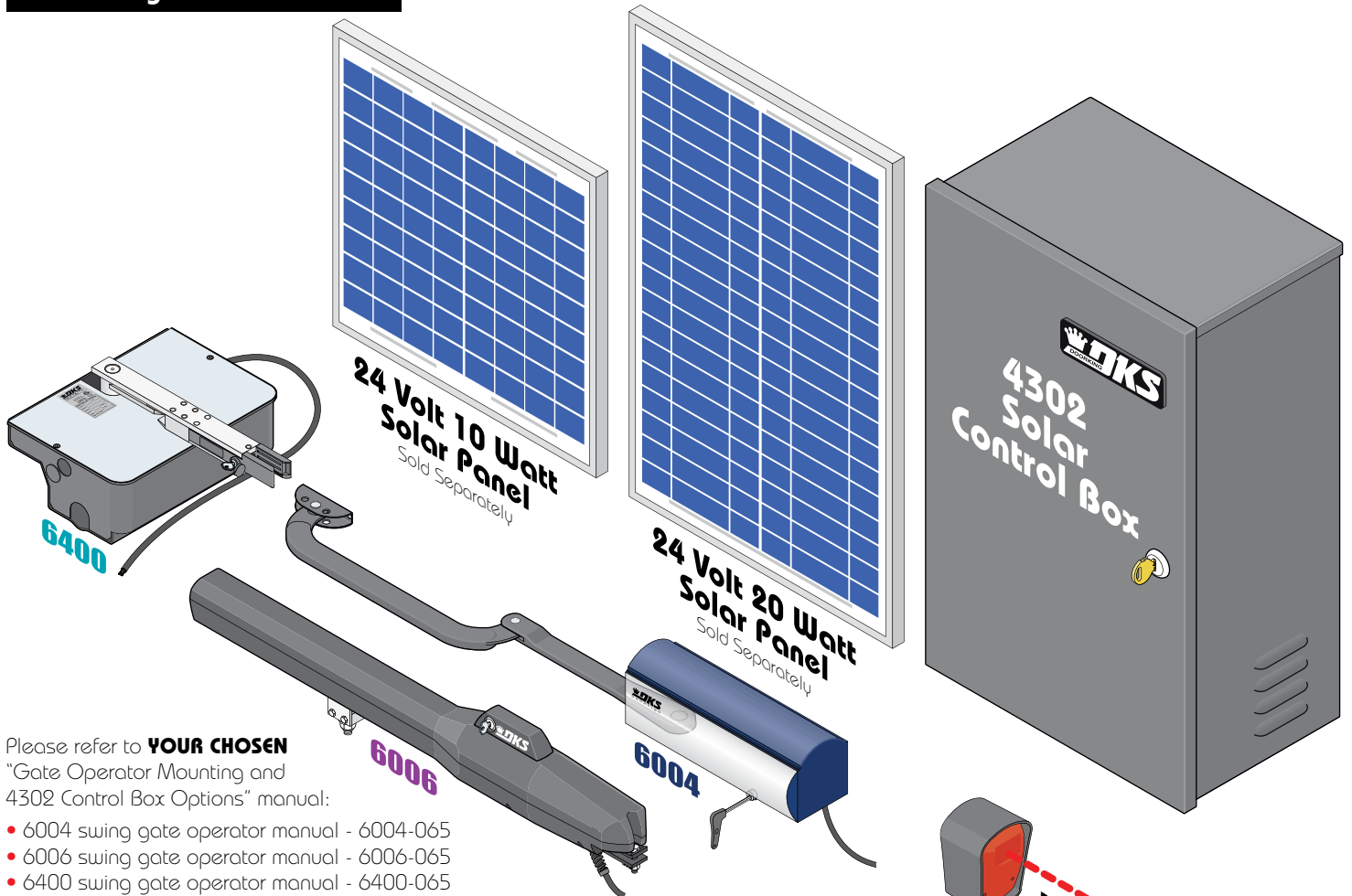

Please refer to **YOUR CHOSEN** "Gate Operator Mounting and 4302 Control Box Options" manual:

- 6004 swing gate operator manual - 6004-065
- 6006 swing gate operator manual - 6006-065
- 6400 swing gate operator manual - 6400-065

**THIS PRODUCT IS TO BE INSTALLED AND SERVICED BY A TRAINED GATE/DOOR SYSTEMS TECHNICIAN ONLY.** Visit [www.doorking.com/dealer-locator](http://www.doorking.com/dealer-locator) to find a professional installing and servicing dealer in your area.

Date Installed: \_\_\_\_\_

Installer/Company Name: \_\_\_\_\_

\_\_\_\_\_

Phone Number: \_\_\_\_\_

Circuit Board Serial Number and Revision Letter: \_\_\_\_\_

**Leave manual with owner : Property owner checklist in back of manual for new installation verification**

Copyright 2024 DoorKing®, Inc. All rights reserved.



Listed to ANSI/CAN/UL 325



# QUICK GUIDE: DIP-Switches

See page 22 for more info about DIP-switches.

Whenever any programming or switch setting on the control board is changed, press the reset button for new settings to take effect.

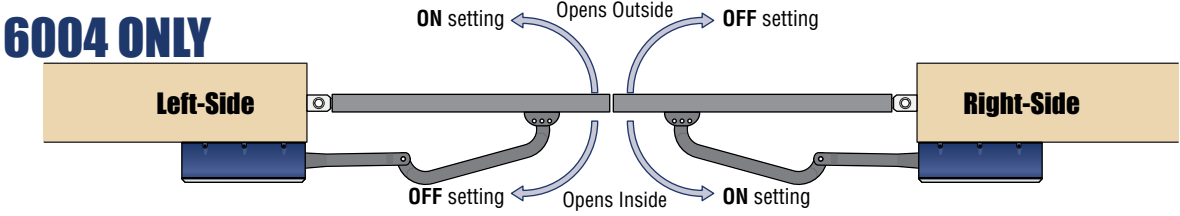
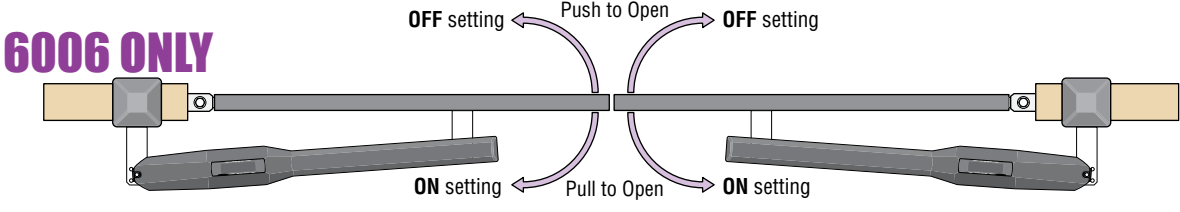
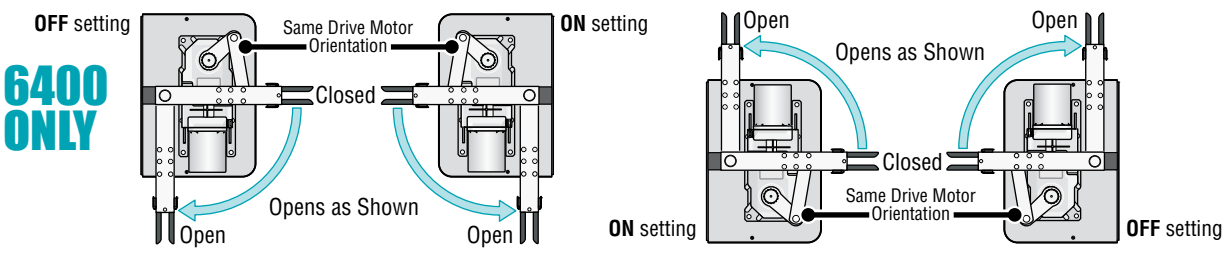
SW 1 - Top 8 Switches			
Switch	Function	Setting	Description
1	<p><b>Opening Direction of PRIMARY Operator</b></p> <p>The operator <b>MUST OPEN GATE</b> upon initial power up and <b>OPEN</b> command. If the operator closes gate after giving open command, shut off power and reverse this switch setting otherwise operator will <b>NOT</b> function correctly.</p>		
	<p><b>6004 ONLY</b></p> 		
	<p><b>6006 ONLY</b></p> 		
1	<p><b>6400 ONLY</b></p> 		
	2	Opening Direction of <b>SECONDARY</b> Operator	<p>Same opening directions as illustrated above for the primary operator type.</p> <ul style="list-style-type: none"> <li>Switch 2 will be the <b>SAME</b> setting as switch 1 for the 6006.</li> <li>Switch 2 will be the <b>OPPOSITE</b> setting as switch 1 for the 6004 and 6400.</li> </ul> <p>Note: SW1, switch 7 <b>MUST</b> also be <b>ON</b> when using a secondary operator.</p>
3	Not Used	OFF	Leave in the OFF position.
4	Auto-Close Timer	OFF	Auto-close timer is OFF. Manual input required to close gate.
		ON	Auto-close timer is ON. Adjustable from 1-23 seconds.
5	Reverse	OFF (normal)	Terminal #8 is a standard Reverse input.
	Not Used	ON	On setting is <b>NOT</b> used.
6	Overlapping Gates	OFF	Both operators start at the same time.
		ON	Secondary operator opens 1-2 seconds before primary operator. Vice-versa when closing.
7	Single	OFF	Switch must be OFF for single operator.
	Dual	ON	Switch must be ON when (dual) operators are used.
8	Input Power	OFF	Switch <b>MUST</b> be in the OFF position.

SW 2 - Bottom 4 Switches			
1 and 2	Relay Operation	1-OFF 2-ON	Circuit board relay activates when gate is <b>NOT</b> closed.
3	Not Used	OFF	Leave in the OFF position.
4	Spare	OFF	Leave in the OFF position.



# SOLAR CONTROL BOX SPECIFICATIONS

<b>Class of Operation</b>	Models 6004 and 6400 - UL325 Class I • 6006 UL325 Class I and II
<b>Type of Gate</b>	Residential Vehicular Automated Gates Only
<b>Voltage / Phase</b>	24 Volt Solar Input Power – 24 VDC Output Power to Gate Operators
<b>Battery Capacity</b>	Two - 12 Volt 18 Amp/Hour Dry Cell OR Two - 12 Volt 35 Amp/Hour Dry Cell
<b>Solar Panel Voltage</b>	24 Volt 10 Watt for 18 Amp/Hour Dry Cells OR 24 Volt 20 Watt for 35 Amp/Hour Dry Cells
<b>Circuit Board Model</b>	4302-018 revision A or higher.
<b>Inherent Entrapment Protection Device</b>	Inherent Reverse Sensor System (Type A)
<b>External Entrapment Protection Device Inputs</b>	Monitored input connection for Non-contact Sensor - Photo Sensor (Type B1) Monitored input connection for Contact Sensor - Reversing Edge (Type B2)

**Entrapment Protection must be provided for the gate system where the risk of entrapment or obstruction exists. The operator will not run without one or more monitored type B1 or B2 entrapment protection devices in EACH entrapment area.**

## 18 Amp/Hr Control Box

P/N 4302-314

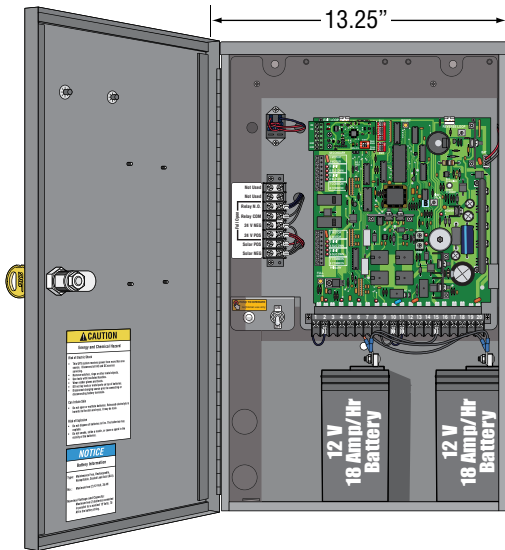

## No Batteries Control Box

P/N 4302-313

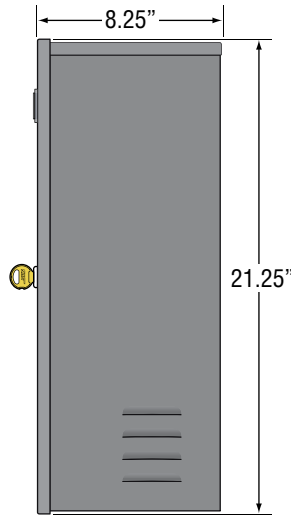

## 35 Amp/Hr Control Box

P/N 4302-315

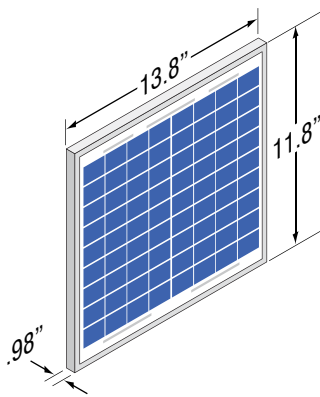
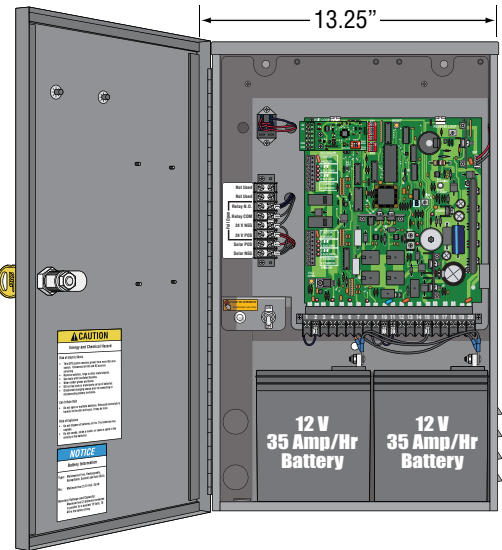

**Optional 24 Volt 10 Watt Solar Panel only for 18 Amp/Hr Batteries**

P/N 2000-077

**Optional Mounting Post Kit for Control Box**

P/N 1000-045

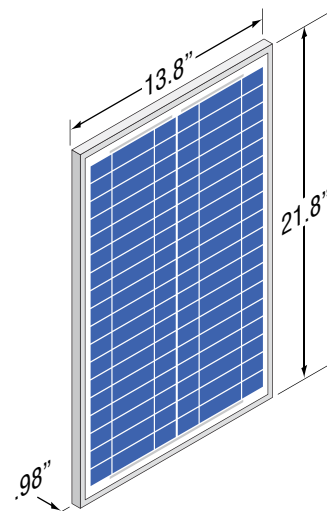

**Optional 24 Volt 20 Watt Solar Panel only for 35 Amp/Hr Batteries**

P/N 2000-076

**Type of wiring to be used on ALL external devices:**  
**A) Type CL2, CL2P, CL2R, or CL2X.**  
**B) Other cable with equivalent or better electrical, mechanical, and flammability ratings.**

DoorKing, Inc. reserves the right to make changes in the products described in this manual without notice and without obligation of DoorKing, Inc. to notify any persons of any such revisions or changes. Additionally, DoorKing, Inc. makes no representations or warranties with respect to this manual. This manual is copyrighted, all rights reserved. No portion of this manual may be copied, reproduced, translated, or reduced to any electronic medium without prior written consent from DoorKing, Inc.



# TABLE OF CONTENTS

## Quick Guides

Quick Guide: DIP Switches	Quick Guide-1
Quick Guide: Terminals Wiring	Quick Guide-2

## IMPORTANT

Solar Control Box Specifications	Previous Page
Swing Gate Requirements	2-3
ASTM F2200 Standard for Gate Construction	4
Important Safety Instructions	4
Instructions regarding intended installation:	4
Important Notices	5
UL 325 Entrapment Protection	6
Glossary	7

## SECTION 1 - SOLAR PANEL INSTALLATION CONSIDERATIONS 8

1.1 Solar Panel Concerns BEFORE Installation	8
1.2 Solar Panel Positioning	9

## SECTION 2 - WIRING 10

2.1 Control Box Overview	10
2.2 Wiring Operators to 4302 Circuit Board	11
2.3 Entrapment Protection Wiring	12-14
2.4 Full Open & Circuit Board Terminals Wiring	15
2.5 DKS Plug-In Loop Detector (Reverse Loops ONLY)	16
2.6 External Loop Detector Wiring	17
2.7 Battery Wiring	18
2.8 Solar Panel Wiring	19

## SECTION 3 - ADJUSTMENTS 20

3.1 3402 Circuit Board Description and Adjustments	20
3.2 DIP-Switches	21-22
3.3 Limit Sensors Adjustment - Select your specific operator	23-25
6004 Limit Sensors ONLY	23
6006 Limit Sensors ONLY	24
6400 Limit Sensors ONLY	25
3.4 Inherent Reverse Sensor Adjustment	26
3.5 "Optional" Radio Receiver Model (8040-080)	27-29
3.6 Shutdown Conditions	29-30
Soft Shutdown	29
Hard Shutdown (Alarm Activated)	30

## SECTION 4 - MAINTENANCE AND TROUBLESHOOTING 31

4.1 Maintenance	31
4.2 Diagnostics Check	31-32
4.3 Troubleshooting	32-33
4.4 Accessory Items	34
Solar Control Box Schematics	35

## IMPORTANT INFORMATION FOR OWNER 36

Shut-Off Power to Operator OR Shut-OFF Alarm	36
Manually Operating the Gate - NO Power	37
Gate Operator's Monthly Check-Up	38
New Installation Checklist for Installer and Property Owner	39

# Swing Gate Requirements

**This operator is intended for installation only on gates used for vehicles.** Pedestrians must be supplied with a separate access opening. For pedestrian access in the vicinity of an automated vehicular gate, separate pedestrian access shall be provided or available. The pedestrian access shall be in a location such that a pedestrian shall not come in contact with a moving vehicular gate access gate during the entire path of travel of the vehicular gate. A pedestrian gate shall not be incorporated into an automated vehicular gate panel.

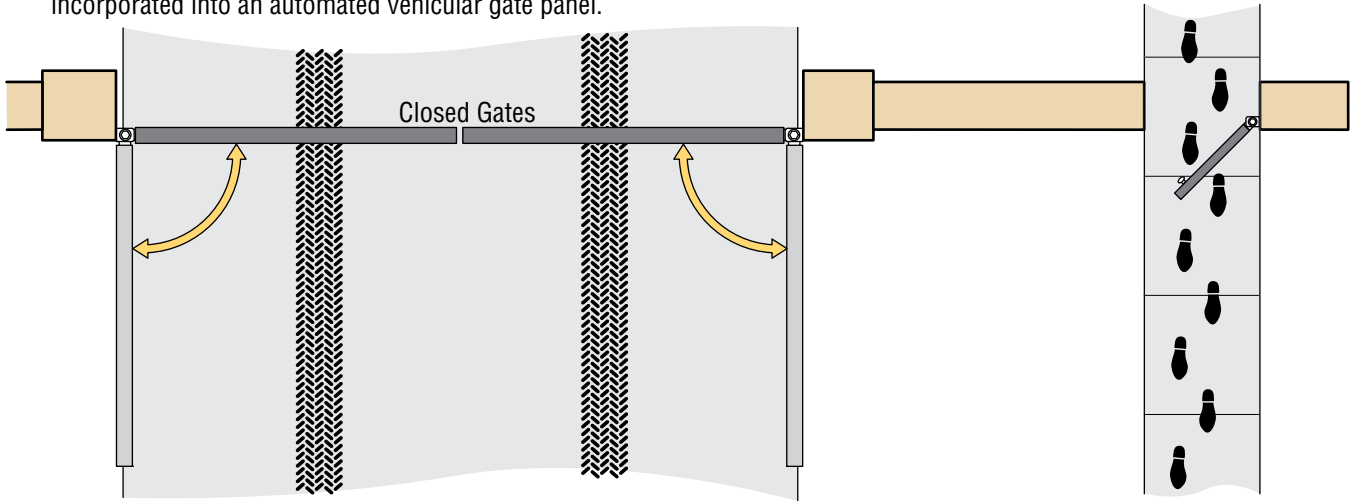

**Entrapment Protection must be provided for the gate system where the risk of entrapment or obstruction exists. The operator will NOT run without one or more monitored type B1 or B2 entrapment protection devices in EACH ENTRAPMENT AREA.**

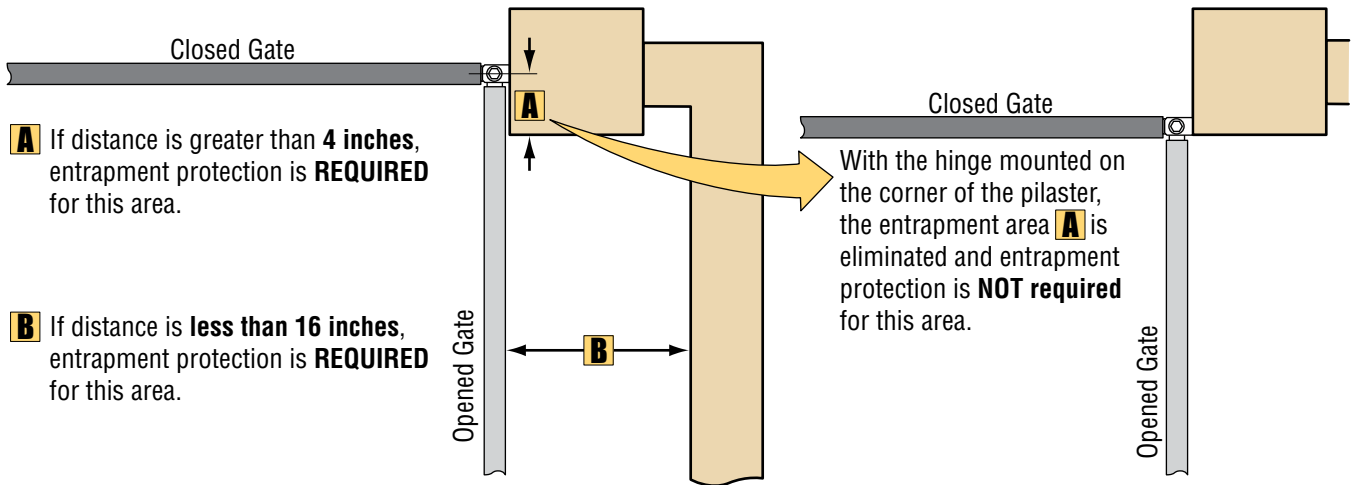

**A** If distance is greater than 4 inches, entrapment protection is **REQUIRED** for this area.

**B** If distance is less than 16 inches, entrapment protection is **REQUIRED** for this area.

**C** If bottom of gate is 4" to 16" above the ground at any part of the gate's traveling path, entrapment protection is **REQUIRED** for this area.

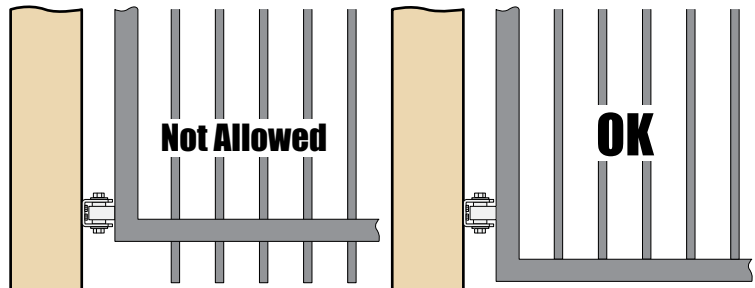
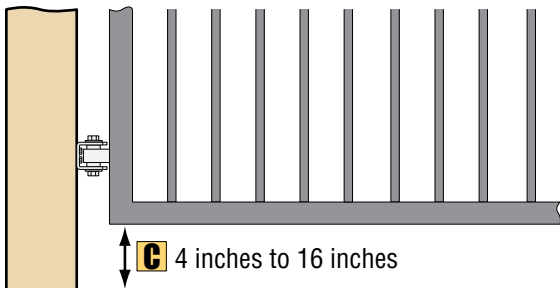

Gates shall have smooth bottom edges, with vertical bottom edged protrusions **NOT** exceeding 0.50 inches.

# Swing Gate Requirements Continued

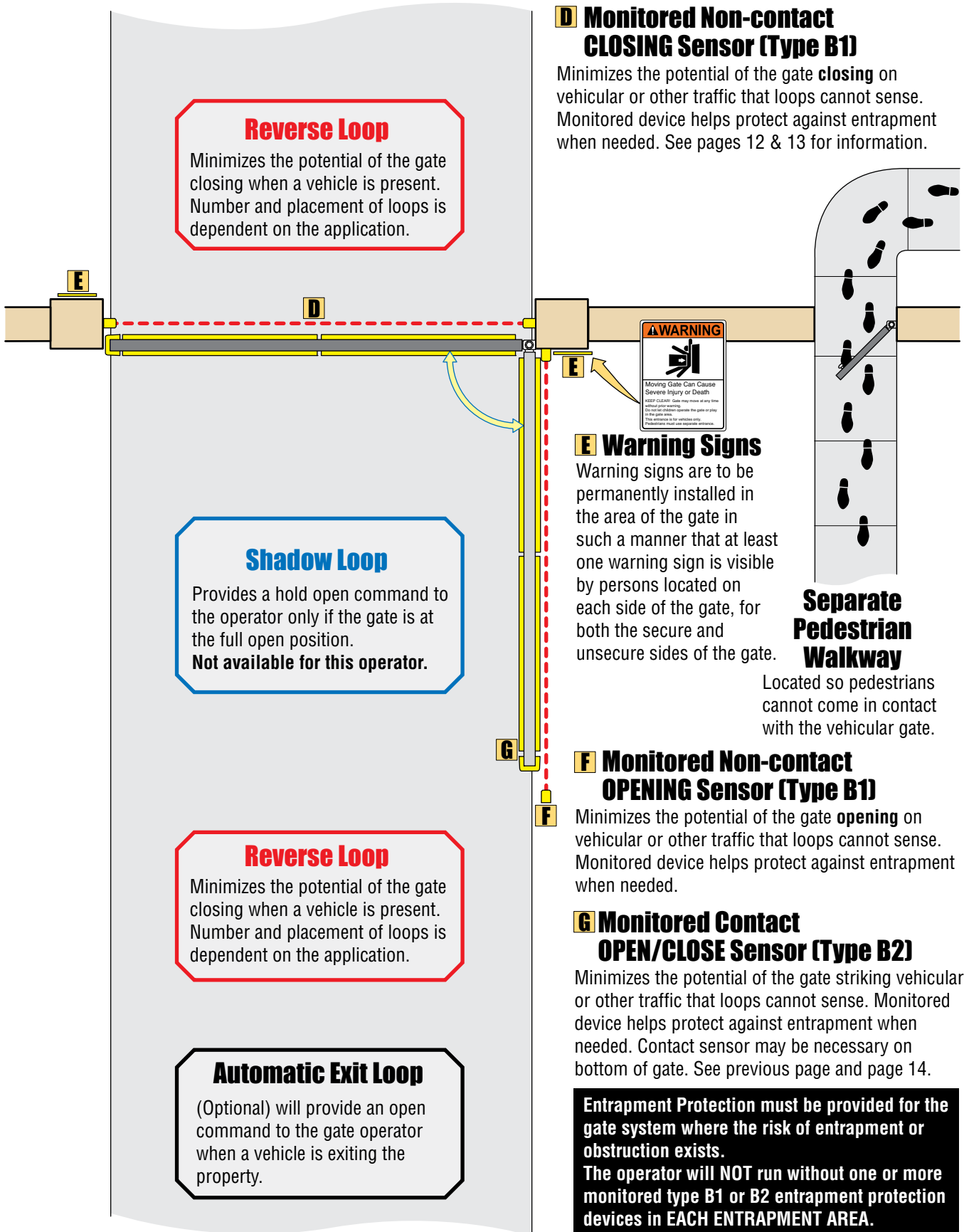

**Reverse Loop**  
 Minimizes the potential of the gate closing when a vehicle is present. Number and placement of loops is dependent on the application.

**Shadow Loop**  
 Provides a hold open command to the operator only if the gate is at the full open position.  
**Not available for this operator.**

**Reverse Loop**  
 Minimizes the potential of the gate closing when a vehicle is present. Number and placement of loops is dependent on the application.

**Automatic Exit Loop**  
 (Optional) will provide an open command to the gate operator when a vehicle is exiting the property.

**D Monitored Non-contact CLOSING Sensor (Type B1)**

Minimizes the potential of the gate **closing** on vehicular or other traffic that loops cannot sense. Monitored device helps protect against entrapment when needed. See pages 12 & 13 for information.



**E Warning Signs**

Warning signs are to be permanently installed in the area of the gate in such a manner that at least one warning sign is visible by persons located on each side of the gate, for both the secure and unsecure sides of the gate.

**Separate Pedestrian Walkway**

Located so pedestrians cannot come in contact with the vehicular gate.

**F Monitored Non-contact OPENING Sensor (Type B1)**

Minimizes the potential of the gate **opening** on vehicular or other traffic that loops cannot sense. Monitored device helps protect against entrapment when needed.

**G Monitored Contact OPEN/CLOSE Sensor (Type B2)**

Minimizes the potential of the gate striking vehicular or other traffic that loops cannot sense. Monitored device helps protect against entrapment when needed. Contact sensor may be necessary on bottom of gate. See previous page and page 14.

**Entrapment Protection must be provided for the gate system where the risk of entrapment or obstruction exists. The operator will NOT run without one or more monitored type B1 or B2 entrapment protection devices in EACH ENTRAPMENT AREA.**

# ASTM F2200 Standard for Gate Construction

Vehicular gates should be constructed and installed in accordance with ASTM F2200; Standard Specification for Automated Vehicular Gate Construction. For a copy of this standard, contact ASTM directly at 610-832-9585; service@astm.org; or www.astm.org.

## Important Safety Instructions

### **WARNING - To reduce the risk of severe injury or death:**

1. READ AND FOLLOW ALL INSTRUCTIONS.
2. Never let children operate or play with gate controls. Keep the remote control away from children.
3. Always keep people and objects away from gate. **NO ONE SHOULD CROSS THE PATH OF THE MOVING GATE.**
4. Test the operator monthly. The gate MUST reverse on contact with a rigid object or stop or reverse when an object activates the non-contact sensors. After adjusting the force or the limit of travel, retest the gate operator. Failure to adjust and retest the gate operator properly can increase the risk of severe injury or death.
5. Use the manual release only when the gate is not moving.
6. KEEP GATES PROPERLY MAINTAINED. Read the owner's manual. Have a qualified service person make repairs to gate hardware.
7. The operator is intended for installation on gates used for vehicles. Pedestrians must be supplied with a separate access opening. The pedestrian access opening shall be designed to promote pedestrian usage. Locate the gate such that persons will not come in contact with the vehicular gate during the entire path of travel of the vehicular gate.
8. **SAVE THESE INSTRUCTIONS!**

## Instructions regarding intended installation:

- Install the gate operator only if:
  1. The operator is appropriate for the construction of the gate and the usage class of the gate.
  2. All openings of a horizontal slide gate are guarded or screened from the bottom of the gate to a minimum of 6 feet (1.83 m) above the ground to prevent a 2 ¼ inch (57.2 mm) diameter sphere from passing through the openings anywhere in the gate, and in that portion of the adjacent fence that the gate covers in the open position.
  3. All exposed pinch points are eliminated or guarded.
  4. Guarding is supplied for exposed rollers.
- The operator is intended for installation only on gates used for vehicles. Pedestrians must be supplied with a separate access opening. The pedestrian access opening shall be designed to promote pedestrian usage. Locate the gate such that persons will not come in contact with the vehicular gate during the entire path of travel of the vehicular gate.
- The gate must be installed in a location so that enough clearance is supplied between the gate and adjacent structures when opening and closing to reduce the risk of entrapment. Swinging gates should not open into public access areas.
- The gate must be properly installed and work freely in both directions prior to the installation of the gate operator. Do not over-tighten the operator clutch, pressure relief valve or reduce reversing sensitivity to compensate for a damaged gate.
- For gate operators utilizing Type D protection:
  1. The gate operator controls must be placed so that the user has full view of the gate area when the gate is moving.
  2. A warning placard shall be placed adjacent to the controls.
  3. An automatic closing device (such as a timer, loop sensor, or similar device) shall not be employed.
  4. No other activation device shall be connected.
- Controls intended for user activation must be located at least six feet (6') away from any moving part of the gate and where the user is prevented from reaching over, under, around or through the gate to operate the controls. Outdoor or easily accessible controls should have a security feature to prevent unauthorized use.
- The Stop and/or Reset button must be located in the line-of-sight of the gate. Activation of the reset control shall not cause the operator to start.
- Warning signs are to be permanently installed in the area of the gate in such a manner that at least one warning sign is visible by persons located on each side of the gate, for both the secure and unsecure sides of the gate.
- For gate operators utilizing a non-contact sensor:
  1. See the instructions on the placement of non-contact sensors for each type of application.
  2. Care shall be exercised to reduce the risk of nuisance tripping, such as when a vehicle trips the sensor while the gate is still moving in the opening direction.
  3. One or more non-contact sensors shall be located where the risk of entrapment or obstruction exist, such as the perimeter reachable by a moving gate or barrier.
- For gate operators utilizing contact sensors:
  1. One or more contact sensors shall be located where the risk of entrapment or obstruction exist, such as at the leading edge, trailing edge, and post mounted both inside and outside of a vehicular horizontal slide gate.
  2. One or more contact sensors shall be located at the bottom edge of a vehicular vertical lift gate.
  3. One or more contact sensors shall be located at the pinch point of a vehicular vertical pivot gate.
  4. A hardwired contact sensor shall be located and its wiring arranged so that the communication between the sensor and the gate operator is not subjected to mechanical damage.
  5. A wireless contact sensor such as one that transmits radio frequency (RF) signals to the gate operator for entrapment protection functions shall be located where the transmission of the signals are not obstructed or impeded by building structures, natural landscaping or similar obstructions. A wireless contact sensor shall function under the intended end-use conditions.
  6. One or more contact sensors shall be located at the bottom edge of a vertical barrier (arm).
- Be sure you have instructed the owner of the gate operator about safe and proper operation and testing of the gate operator.

# Important Notices

Vehicular gate operator products provide convenience and security. However, gate operators must use high levels of force to move gates and most people underestimate the power of these systems and do not realize the potential hazards associated with an incorrectly designed or installed system. These hazards may include:

- Pinch points
- Entrapment areas
- Reach through hazards
- Absence of entrapment protection devices
- Improperly located access controls
- Absence of vehicle protection devices
- Absence of controlled pedestrian access

In addition to these potential hazards, automated vehicular gate systems must be installed in accordance with the UL 325 Safety Standard and the ASTM F2200 Construction Standard. Most people are unaware of, or are not familiar with, these standards. If an automated vehicular gate system is not properly designed, installed, used and maintained, severe injuries or death can result. Be sure that the installer has instructed you on the proper operation of the gate and gate operator system.

Be sure that the installer has trained you on proper and safe operation of this gate operating system and about the basic functions of the required reversing systems associated with your gate operating system and how to test them. These include reversing loops, inherent reversing system, electric edges, photoelectric cells, or other external devices.

- This Owner's Manual is your property. Keep it in a safe place for future reference.
- Be sure that all access control devices are installed a minimum distance of 6 feet away from the gate and gate operator, or in such a way that a person cannot touch the gate or gate operator while using the device. If access control devices are installed in violation of these restrictions, immediately remove the gate operator from service and contact your installing dealer.

**Opening device MUST be mounted a minimum of 6 feet from the gate and NOT accessible through the gate!**



- Loops and loop detectors, photo-cells or other equivalent devices must be installed to prevent the gate from closing on vehicular traffic.
- The speed limit for vehicular traffic through the gate area is 5 MPH. Install speed bumps and signs to keep vehicular traffic from speeding through the gate area. Failure to adhere to posted speed limits can result in damage to the gate, gate operator, and to the vehicle.
- Be sure that all persons who will use the gate system are familiar with the proper use of the gate and gate operator and are familiar with the possible hazards associated with the gate system.
- Warning signs are to be permanently installed in the area of the gate in such a manner that at least one warning sign is visible by persons located on each side of the gate, for both the secure and unsecure sides of the gate.
- It is your responsibility to periodically check all entrapment protection devices. If any of these devices are observed to function improperly, remove the operator from service immediately and contact your installing or servicing dealer.
- Follow the recommended maintenance schedule.
- Do not allow children to play in the area of the operator or to play with any gate-operating device.
- To remove the gate operator from service, operate the gate to the full open position and then shut off power to the operator at the service panel.



# UL 325 Entrapment Protection

## UL 325 Classifications

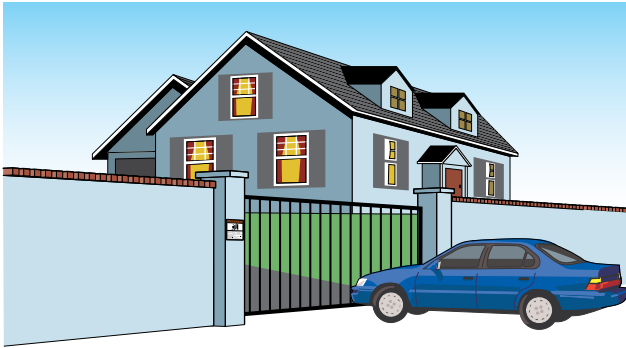

### Class I - Residential Vehicular Gate Operator

A vehicular gate operator (or system) intended for use in garages or parking areas associated with a residence of one-to four single families.

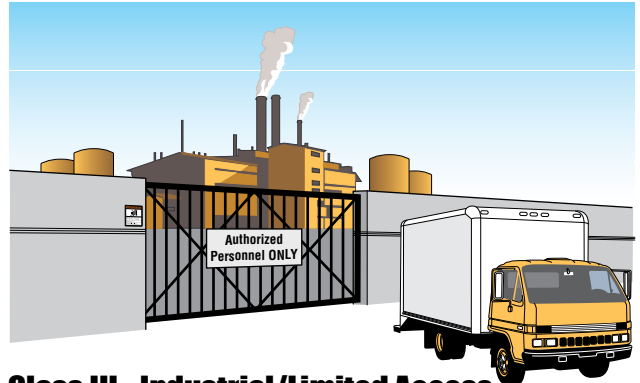

### Class III - Industrial/Limited Access Vehicular Gate Operator

A vehicular gate operator (or system) intended for use in an industrial location or building such as a factory or loading dock area or other locations not accessible by or intended to service the general public.

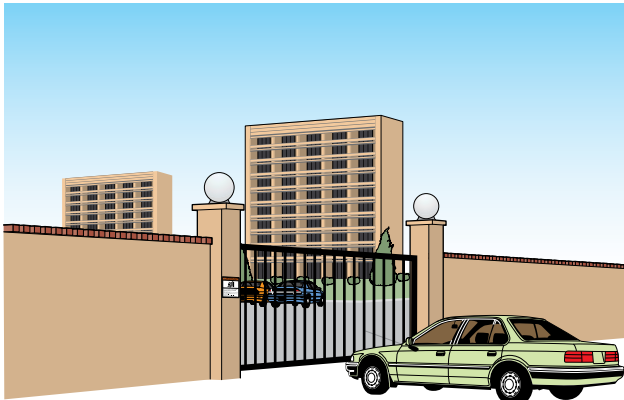

### Class II - Commercial/General Access Vehicular Gate Operator

A vehicular gate operator (or system) intended for use in a commercial location or building such as a multi-family housing unit (five or more single family units), hotel, garages, retail store, or other buildings accessible by or servicing the general public.



### Class IV - Restricted Access Vehicular Gate Operator

A vehicular gate operator (or system) intended for use in a guarded industrial location or building such as an airport security area or other restricted access locations not servicing the general public, in which unauthorized access is prevented via supervision by security personnel.

## Gate Operator Category

	Horizontal Slide, Vertical Lift, Vertical Pivot, Horizontal Bifold	Swing, Vertical Barrier (Arm)
Entrapment Protection Types	A, B1*, B2* or D	A, B1*, B2*, C or D

**Type A** - Inherent entrapment protection system.

**Type B1** - Non-contact sensor (photoelectric sensor or the equivalent).

**Type B2** - Contact sensor (edge device or equivalent).

**Type C** - Inherent force limiting, inherent adjustable clutch or inherent pressure relief device.

**Type D** - Actuating device requiring constant pressure to maintain opening or closing motion of the gate.

\* B1 and B2 means of entrapment protection must be MONITORED.

**Vertical Barrier Note:** Barrier gate operators (arm) that is not intended to move toward a rigid object closer than 16 inches (406 mm) are not required to be provided with a means of entrapment protection.

# Glossary

**GATE** - A moving barrier such as a swinging, sliding, raising, lowering, folding, pivoting, or the like, barrier, that is a stand-alone passage barrier or is that portion of a wall or fence system that controls entrance and/or egress by persons or vehicles and completes the perimeter of a defined area.

**RESIDENTIAL VEHICULAR GATE OPERATOR – CLASS I** - A vehicular gate operator (or system) intended for use in a home of one-to four single family dwelling, or garage or parking area associated therewith.

**COMMERCIAL / GENERAL ACCESS VEHICULAR GATE OPERATOR - CLASS II** - A vehicular gate operator (or system) intended for use in a commercial location or building such as a multi-family housing unit (five or more single family units), hotels, garages, retail store, or other building servicing the general public.

**INDUSTRIAL / LIMITED ACCESS VEHICULAR GATE OPERATOR - CLASS III** - A vehicular gate operator (or system) intended for use in an industrial location or building such as a factory or loading dock area or other locations not intended to service the general public.

**RESTRICTED ACCESS VEHICULAR GATE OPERATOR - CLASS IV** - A vehicular gate operator (or system) intended for use in a guarded industrial location or building such as an airport security area or other restricted access locations not servicing the general public, in which unauthorized access is prevented via supervision by security personnel.

**VEHICULAR BARRIER (ARM) OPERATOR (OR SYSTEM)** - An operator (or system) that controls a cantilever type device (or system), consisting of a mechanical arm or barrier that moves in a vertical arc, intended for vehicular traffic flow at entrances or exits to areas such as parking garages, lots or toll areas.

**VEHICULAR HORIZONTAL SLIDE-GATE OPERATOR (OR SYSTEM)** - A vehicular gate operator (or system) that controls a gate which slides in a horizontal direction that is intended for use for vehicular entrance and exit to a drive, parking lot, or the like.

**VEHICULAR SWING-GATE OPERATOR (OR SYSTEM)** - A vehicular gate operator (or system) that controls a gate which moves in an arc in a horizontal plane that is intended for use for vehicular entrance and exit to a drive, parking lot, or the like.

**SYSTEM** - In the context of these requirements, a system refers to a group of interacting devices intended to perform a common function.

**WIRED CONTROL** - A control implemented in a form of fixed physical interconnections between the control, the associated devices, and an operator to perform predetermined functions in response to input signals.

**WIRELESS CONTROL** - A control implemented in means other than fixed physical interconnections (such as radio waves or infrared beams) between the control, the associated devices, and an operator to perform predetermined functions in response to input signals.

**INHERENT ENTRAPMENT PROTECTION SYSTEM** - A system, examples being a motor current or speed sensing system, which provides protection against entrapment upon sensing an object and is incorporated as a permanent and integral part of the operator.

**EXTERNAL ENTRAPMENT PROTECTION DEVICE** - A device, examples being an edge sensor, a photoelectric sensor, or similar entrapment protection device, which provides protection against entrapment when activated and is not incorporated as a permanent part of an operator.

**ENTRAPMENT** - The condition when a person is caught or held in a position that increases the risk of injury.

# SECTION 1 - SOLAR PANEL INSTALLATION CONSIDERATIONS

## 1.1 Concerns BEFORE Installation

Correct positioning of the solar panel will determine the efficiency of the system. In general, the panel should be facing **TRUE SOUTH** at a specific **TILT ANGLE** towards the sun using the information provided on the next page to achieve the highest efficiency. Some re-adjustment of the panel might be necessary to over time to “Fine Tune” the systems efficiency. The solar panel should be installed as close as possible to the control box in an area free and clear of **ALL** obstructions and shadows during the **ENTIRE** day. Generally, if the solar panel is **NOT** in sunlight, the batteries are **NOT** being charged.

- **Trees / Buildings** that do not block the solar panel from direct sunlight in the summer, **could** block the panel during the winter. The sun’s path across the sky is lower during the winter than in the summer. The shadows that do not obstruct the solar panel during the summer months, will cast longer shadows in the winter, which could block the panel then.
- **Wind** can exert extreme pressure on the solar panel and support post. Make sure they are securely fastened.
- **Dust** can accumulate on the panel over time. Cleaning the panel every so often is necessary to keep the system operating at its highest efficiency.
- **Snow** may cover the panel during the winter. You may want to re-adjust the panel to a steeper angle to allow the snow to slide off. Even then, the panel may still accumulate snow and need to be manually cleaned off when necessary to keep the system functioning.

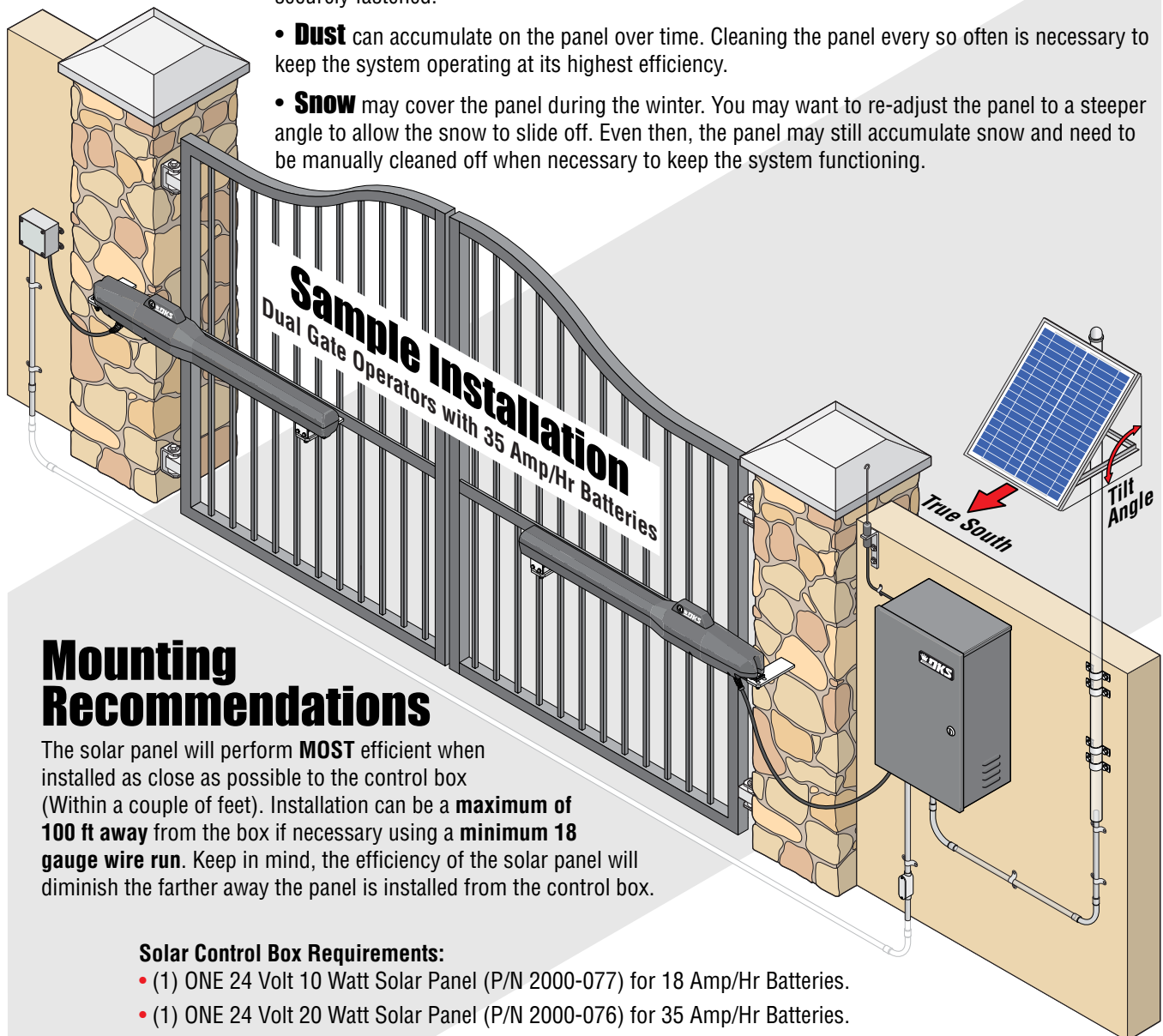

## Mounting Recommendations

The solar panel will perform **MOST** efficient when installed as close as possible to the control box (Within a couple of feet). Installation can be a **maximum of 100 ft away** from the box if necessary using a **minimum 18 gauge wire run**. Keep in mind, the efficiency of the solar panel will diminish the farther away the panel is installed from the control box.

### Solar Control Box Requirements:

- (1) ONE 24 Volt 10 Watt Solar Panel (P/N 2000-077) for 18 Amp/Hr Batteries.
- (1) ONE 24 Volt 20 Watt Solar Panel (P/N 2000-076) for 35 Amp/Hr Batteries.

# 1.2 Solar Panel Positioning

These charts should be used only for estimates. Solar systems can vary from this information. These maps do not take into account small climate changes and may not be 100% accurate for all locations.

## Solar Panel MUST Point "TRUE SOUTH"

It is important for proper system operation that the solar panel is oriented to **TRUE SOUTH**. The directions of magnetic South and TRUE South differ from one another depending on geographic location. The map below shows the difference between magnetic south and TRUE south for your area.

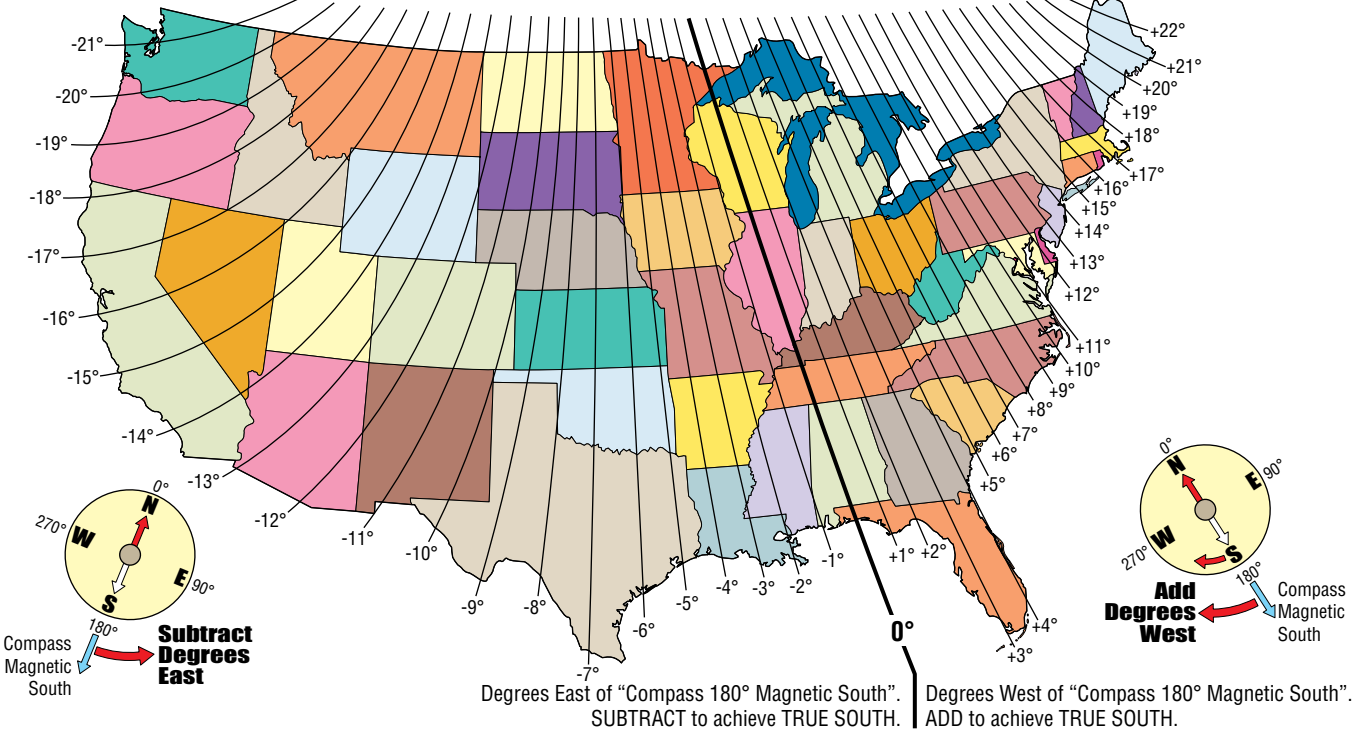

## General Solar Panel "Tilt Angle"

It is simplest to mount the solar panel at a fixed tilt angle and leave it (Shown on chart below). To capture more energy from the sun, you can adjust the tilt angle of the solar panel twice a year (At the beginning of summer and winter). Add approximately 6° in the summer and subtract approximately 6° in the winter from your "general" tilt angle on this chart. Your tilt angle may vary from this.

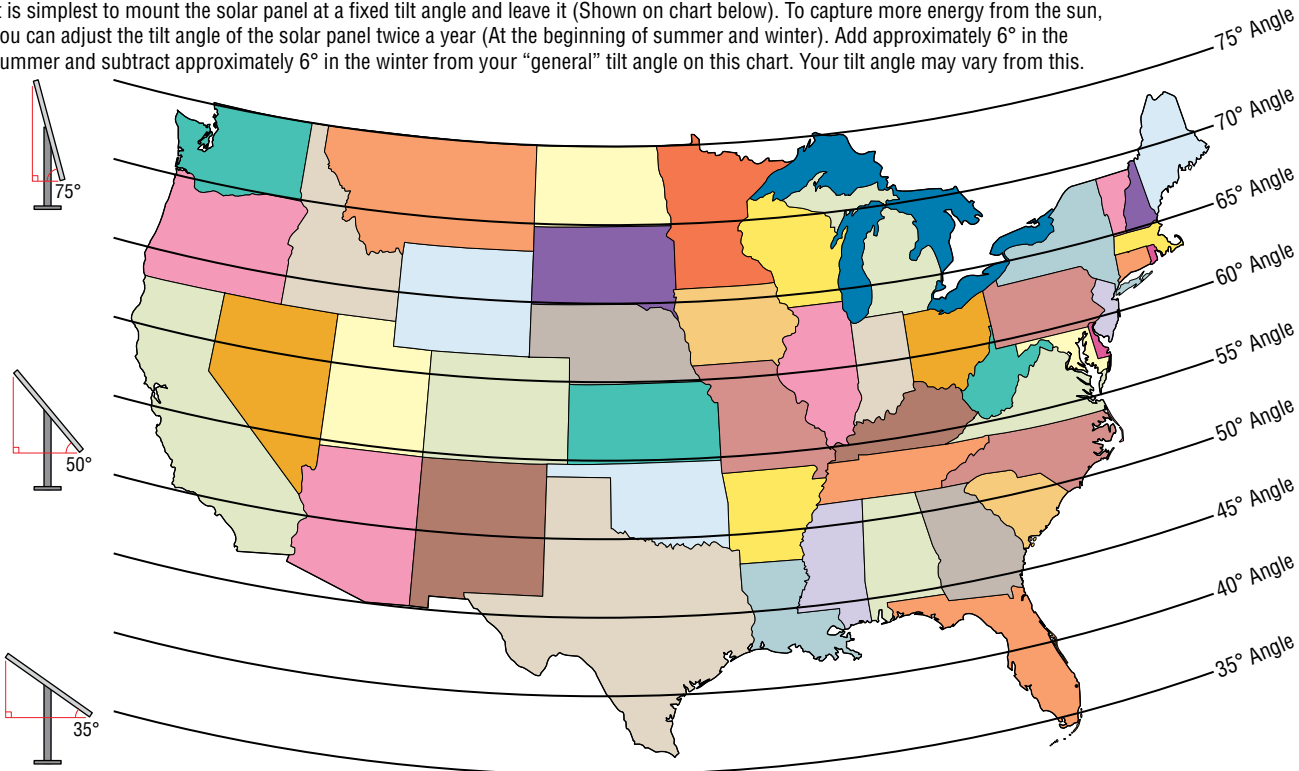

# SECTION 2 - WIRING

Since building codes vary from city to city, we highly recommend that you check with your local building department prior to installing any permanent wiring to be sure that all wiring to the solar control box complies with local code requirements.

## 2.1 Control Box Overview

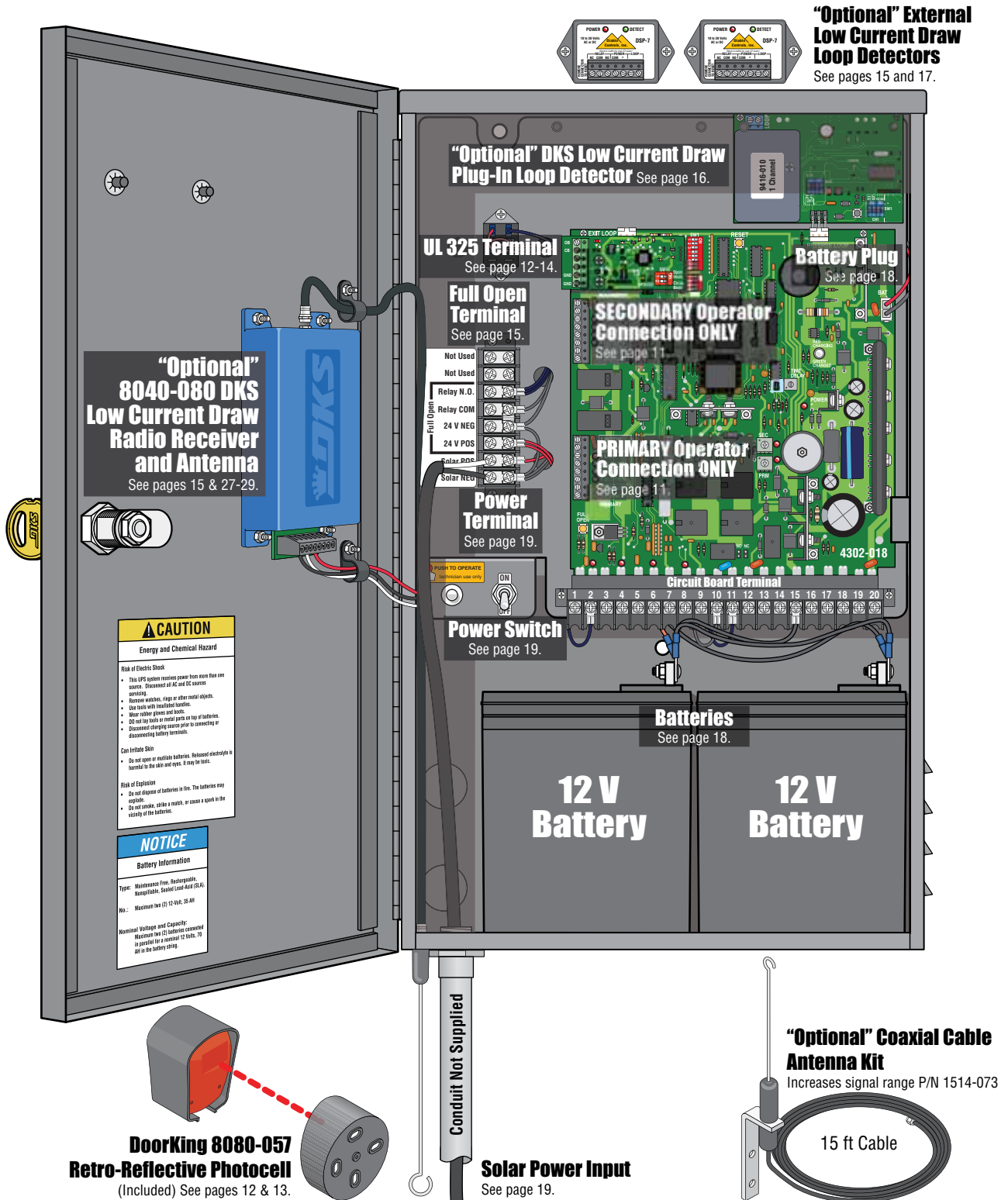



# 2.2 Wiring Operators to 4302 Circuit Board

**IMPORTANT:** External entrapment protection **MUST** be installed or the operator will **NOT** function. See next page.

## Secondary Operator ONLY

**DO NOT** connect primary/single operator to this terminal.

## Primary/Single Operator ONLY

**DO NOT** connect secondary operator to this terminal.

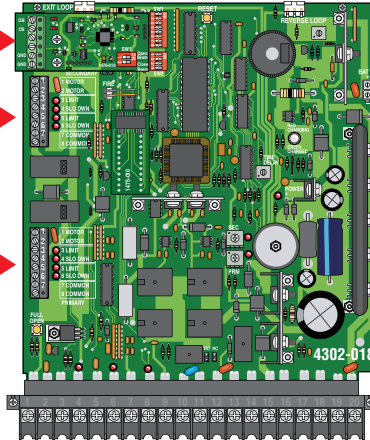

**DO NOT** cycle the operator **BEFORE** setting limit sensors.

### Choose Your Operator Model:

Follow wiring colors for the PRIMARY/Single or DUAL gate operators. If factory wired jumpers are installed on operator terminals, they **must** be removed or operators will **not** function.

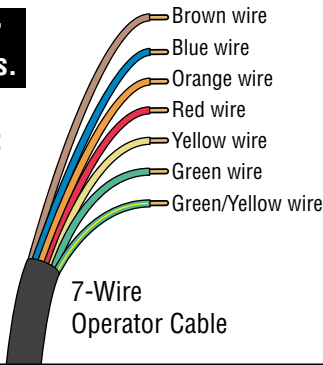

**Discontinued 6005 Operator Wiring ONLY:** Jumpers **MUST** be on operator terminals or 6005 will **NOT** function.

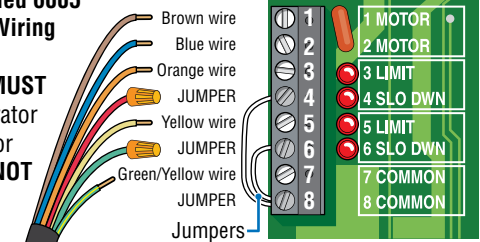

6005 7-Wire Operator Actuator Cable  
Red & Green Wires are Terminated.

### Discontinued 6003



### 6004 Wiring



### 6006 Wiring



Brown wire  
Blue wire  
Orange wire  
Red wire  
Yellow wire  
Green wire  
Green/Yellow wire  
NOT USED

### Primary/Single operator wiring

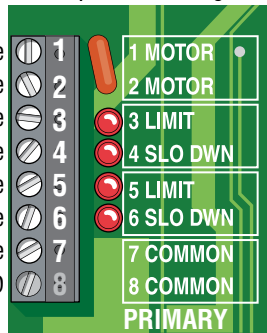

Use 18 AWG wire

### Secondary operator wiring

Brown wire  
Blue wire  
Orange wire  
Red wire  
Yellow wire  
Green wire  
Green/Yellow wire  
NOT USED

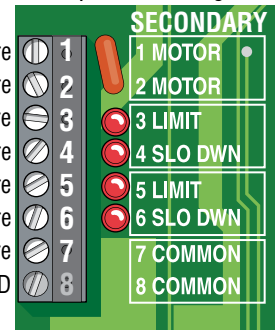

Note: SW1 Switch 7 **MUST** be ON.

### 6400 Wiring

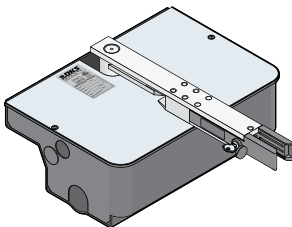

Note: Secondary operator MOTOR wires **MUST** be reversed from the primary operator when using DUAL gate operators.

Brown wire  
Blue wire  
Orange wire  
Red wire  
Yellow wire  
Green wire  
Green/Yellow wire  
NOT USED

### 6400 Primary/Single operator wiring

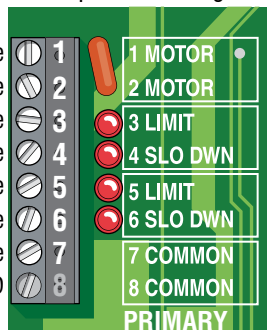

Use 18 AWG wire

### 6400 Secondary operator wiring

Blue wire  
Brown wire  
Orange wire  
Red wire  
Yellow wire  
Green wire  
Green/Yellow wire  
NOT USED

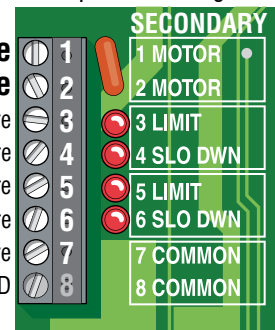

Note: SW1 Switch 7 **MUST** be ON.

# 2.3 Entrapment Protection Wiring

## External Entrapment Protection Devices:

In addition to the inherent reversing sensor system, this operator has a UL 325 terminal for the connection of **photo sensors**-Type B1 and/or **reversing edges**-Type B2 entrapment protection required by UL 325 standards. Install these devices where the risk of entrapment or a safety hazard exists. Installations can vary. ONE DoorKing 8080-057 photocell included, see next page.

**Entrapment Protection must be provided for the gate system where the risk of entrapment or obstruction exists. The operator will NOT run without ONE or more monitored type B1 or B2 external entrapment protection devices installed in each entrapment area.**

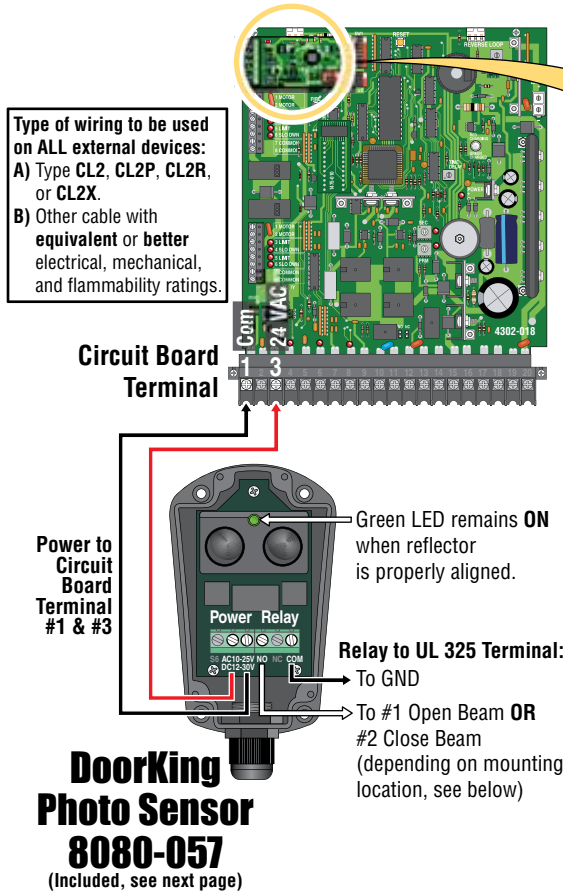

## UL 325 Terminal

**Note:** Only 1 monitored Device can be connected to each input. An **OPTIONAL** Expansion Kit (sold separately) will allow connection for additional devices.

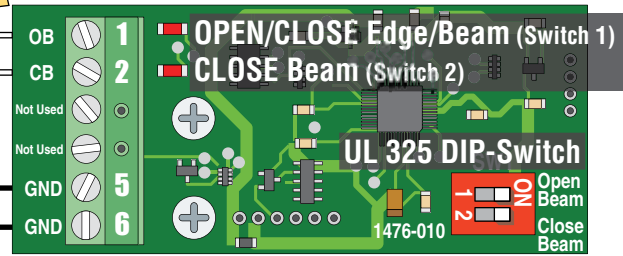

### ONLY connect monitored devices.

The 6-pin terminal can be unplugged from circuit board for easy wire connections.

### LED Notes:

LED OFF: appropriate device is connected.

LED ON: device has been activated.

### Flashing LED:

Device NOT connected. Not appropriate device.

### DIP-switches

**MUST** be turned ON for each device wired to terminal.

### OPEN/CLOSE Edge/Beam UL 325 DIP-Switch 1 ON:

**OPENING:** Obstructed open-direction device will **Reverse** the gate to the CLOSE position.

### CLOSE Beam UL 325 DIP-Switch 2 ON:

**CLOSING:** Obstructed closing-direction photo beam will **REVERSE** the gate to the open position and reset timer when ON.

**Note:** If obstruction occurs again during the closing-direction, Gate will reverse back to open position and enter a soft shutdown.

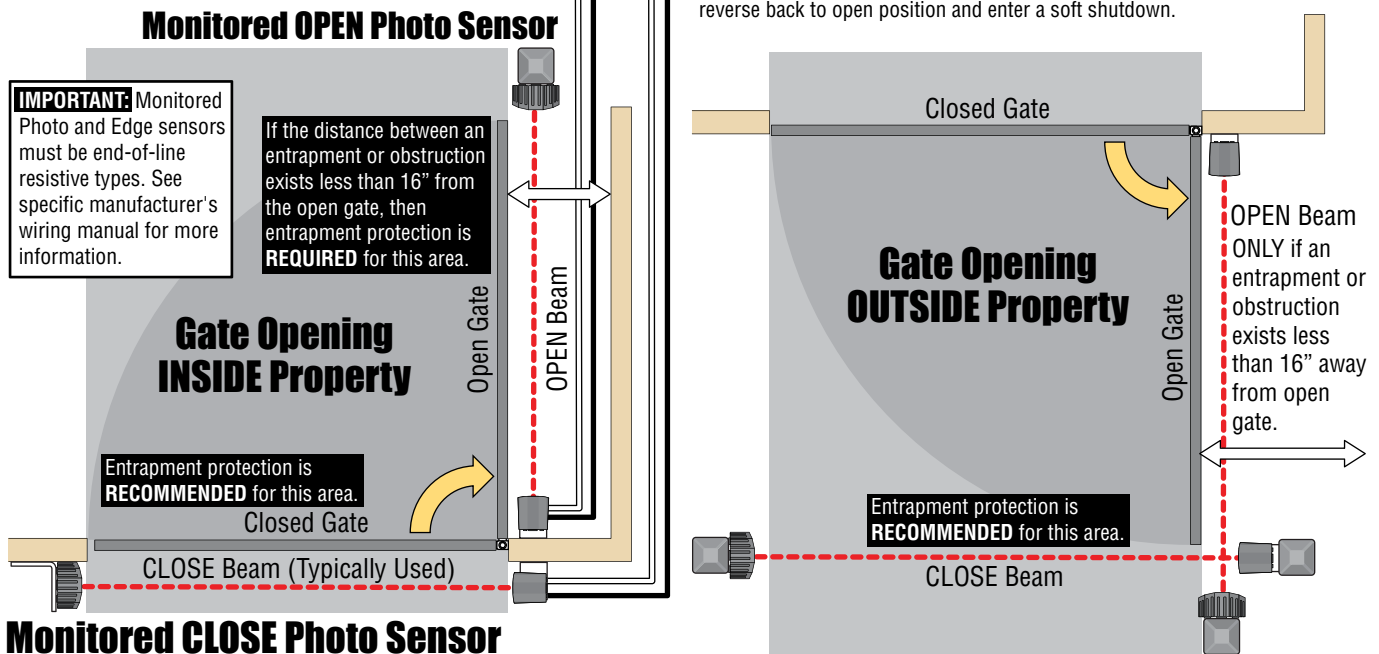

## 2.3 Entrapment Protection Continued

### DoorKing 8080-057 Retro-Reflective Photocell Type B-1

This retro-reflective photocell (UL 325 Type B-1) complies with the 2018 UL 325 standards. It **must** be wired to the control box using the photocell's **NORMALLY OPEN** input so the control box can **monitor the photocell**. The photocell is powered by 24 VAC from the #3 circuit board terminal if desired. The relay output is rated for 1 Amp @ 24 VDC and 1 Amp @ 120 VAC maximum.

It **MUST** be mounted vertically as shown and not horizontally to protect it from the weather. The green LED will remain lit when the reflector is aligned correctly with the photocell. **The photocell has a max sensing range of 35 ft.**

#### Installation

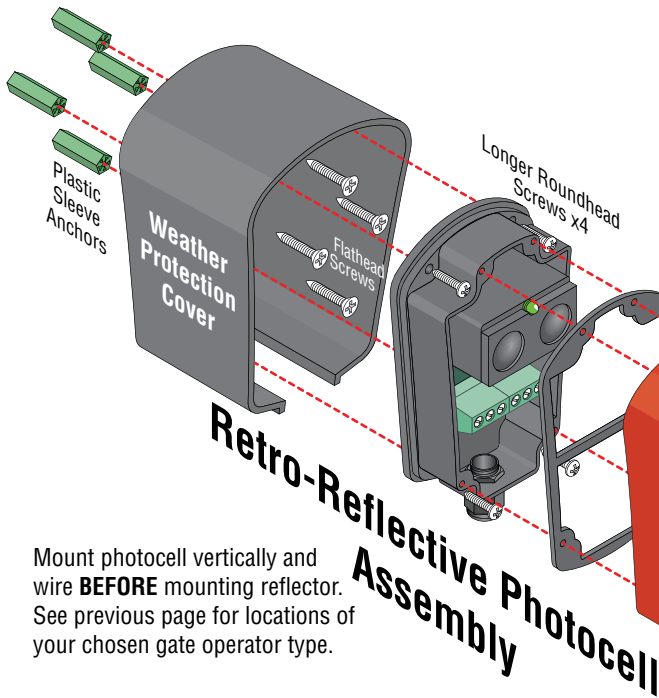

Mount photocell vertically and wire **BEFORE** mounting reflector. See previous page for locations of your chosen gate operator type.

#### Adjustment

After photocell has been mounted, spring mounted beam sensors can be precisely adjusted "Fine tuned" using the 3 screws to help keep the **GREEN LED ON** if necessary.

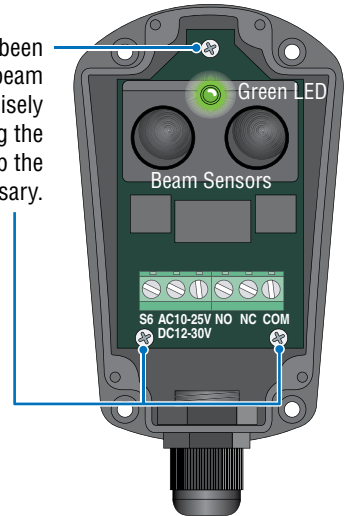

#### Wiring Photocell

Photocell can be powered by the circuit board if desired or use a separate UL listed power supply. **DO NOT** connect power supply to a receptacle controlled by a ON/OFF switch.



Green LED remains **ON** when reflector is properly aligned.

Position reflector directly across from mounted photocell. Green LED on photocell will remain lit when reflector is in correct position. Permanently mount reflector making sure LED remains lit. "Fine tune" photocell alignment if necessary, see above.

Power to Circuit Board Terminal #1 & #3

To Com  
To 24 VAC

Relay to UL 325 Terminal:

To GND

To #1 Open Beam **OR** #2 Close Beam (depending on mounting location, see previous page)

**Note:** Relay contacts are labeled with power applied.



## 2.3 Entrapment Protection Wiring Continued

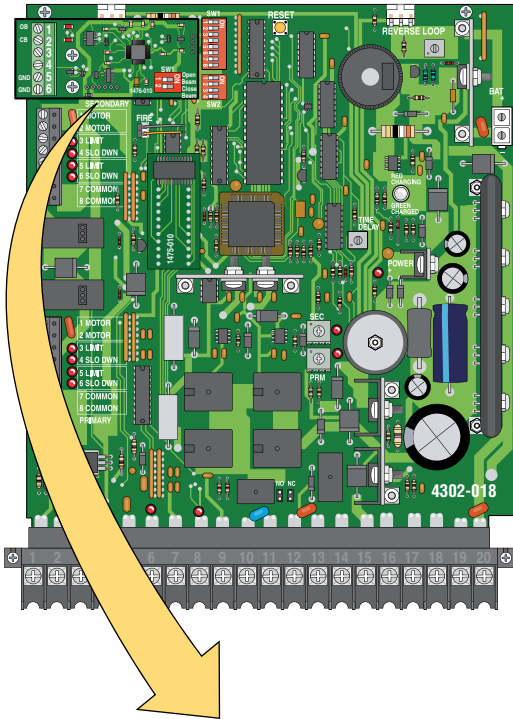

### UL 325 Terminal

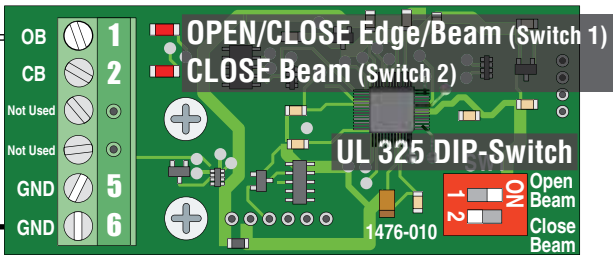

**Note:** Only 1 monitored Device can be connected to each input. An **OPTIONAL** Expansion Kit (sold separately) will allow connection for additional devices.

#### ONLY connect monitored devices.

The 6-pin terminal can be unplugged from circuit board for easy wire connections.

#### LED Notes:

LED OFF: appropriate device is connected.

LED ON: device has been activated.

Flashing LED: Device NOT connected.

Not appropriate device.

**Entrapment Protection must be provided for the gate system where the risk of entrapment or obstruction exists. The operator will not run without one or more monitored type B1 or B2 entrapment protection devices in EACH entrapment area.**

DIP-switch 1 **MUST** be turned **ON** for each device wired to terminal.

Type of wiring to be used on ALL external devices:

A) Type CL2, CL2P, CL2R, or CL2X.

B) Other cable with equivalent or better electrical, mechanical, and flammability ratings.

**Important:** A wireless receiver **CANNOT** be used for reversing edges because of constant power drain on control box batteries.

### HARDWIRED Multiple Reversing Edge Configuration ONLY

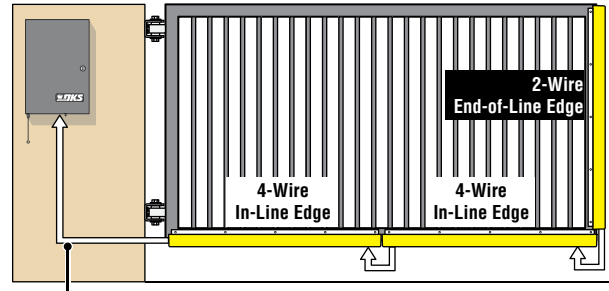

**Wiring to Control Box**  
Hardwiring arranged so that the communication between the sensor and the gate operator is **NOT** subjected to mechanical damage.

**Wiring Multiple Reversing Edges**  
(Add as many "4-wire" In-Line edges as needed)  
**Reversing Edges are wired in series**

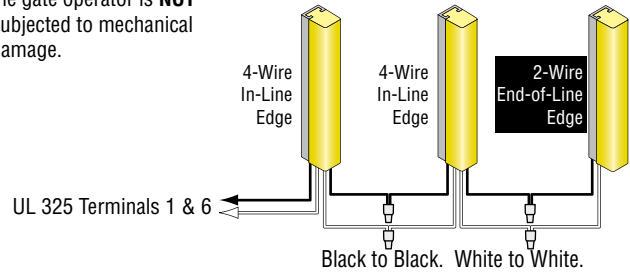

### Monitored OPEN/CLOSE Reversing Edge

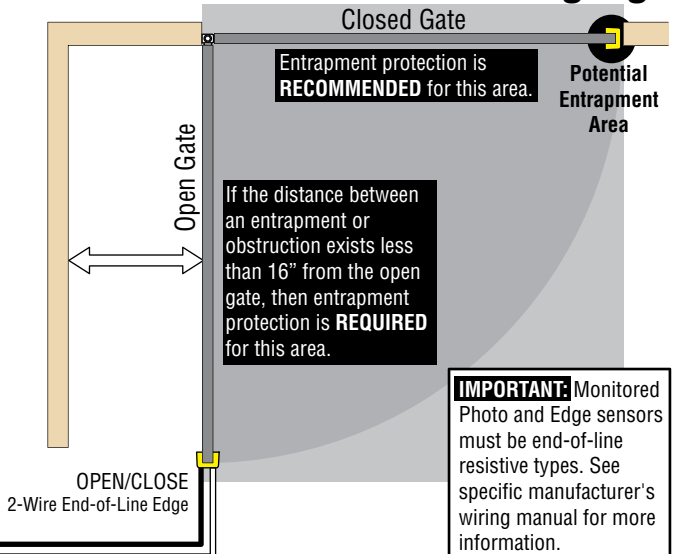



# 2.4 Full Open & Circuit Board Terminals Wiring

**Full Open Terminal Operation:** When the circuit board is **NOT** in use (idle time), power is shut down to it. Power will continue at the **Full Open Terminal at all times**. This allows an access control device - radio receiver, key switch, exit loop or safety opening device to be activated at any time to open the gate. **ANY access control device used needs a relay contact time of AT LEAST 1 SECOND** to bring the circuit board out of "idle time" and operate gate.

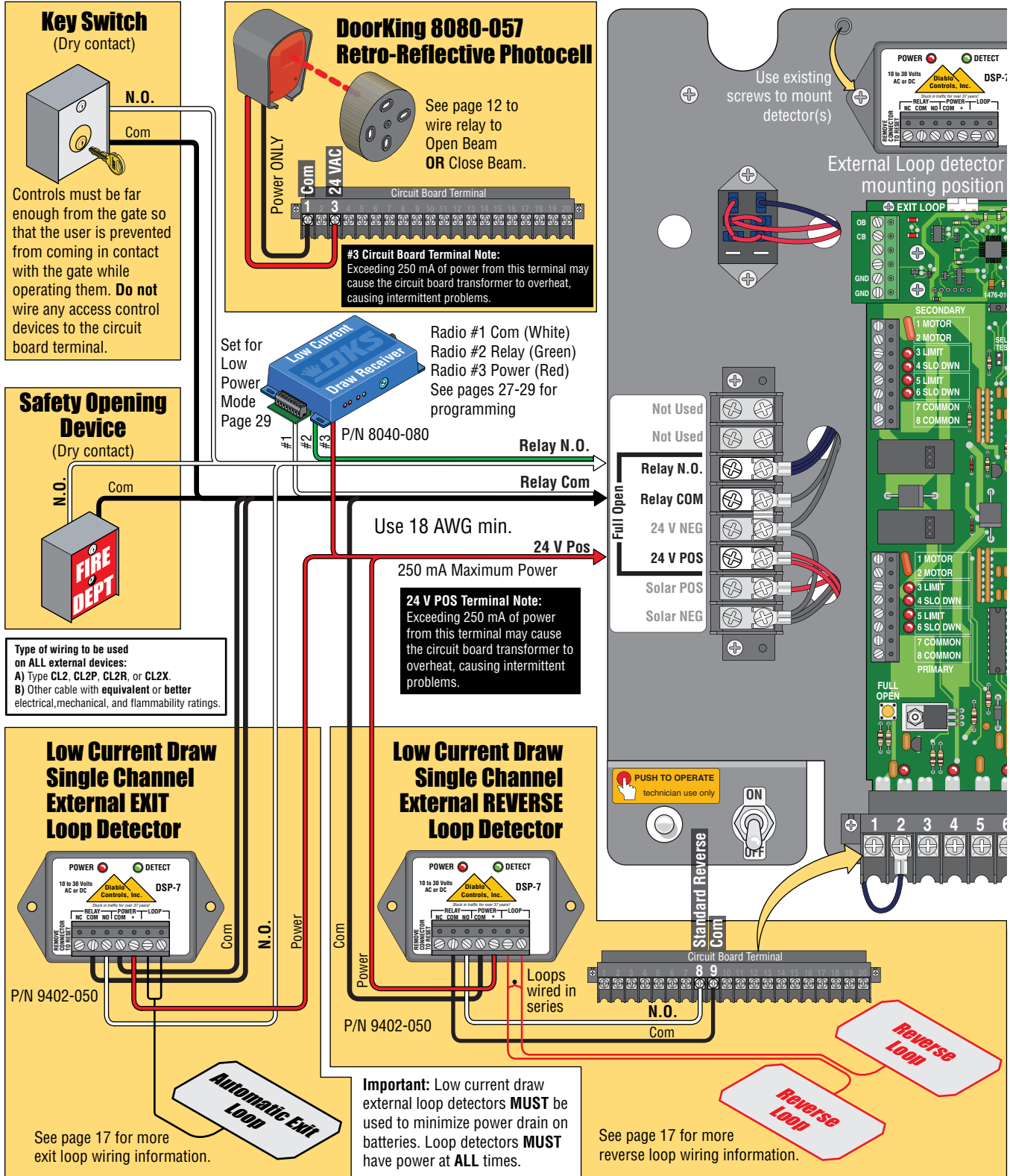



# 2.5 DKS Plug-In Loop Detector (Reverse Loops ONLY)

To help protect the operator from accidentally closing on vehicles in the gate's path, DoorKing highly recommends that loops and loop detectors are used. A loop detection system will sense a vehicle like a metal detector and send a signal to the gate operator preventing the gate from automatically opening or closing on a vehicle when it is in the gate's path. DoorKing recommends that a licensed installer perform this work.

Using a DKS Plug-In loop detector for the reverse loops instead of an external loop detector will allow **less** current draw during "Idle Time" saving battery life.

DoorKing offers a free "Loop and Loop-Detectors Information Manual" PDF located at DoorKing's web site for more information. [www.doorking.com](http://www.doorking.com)

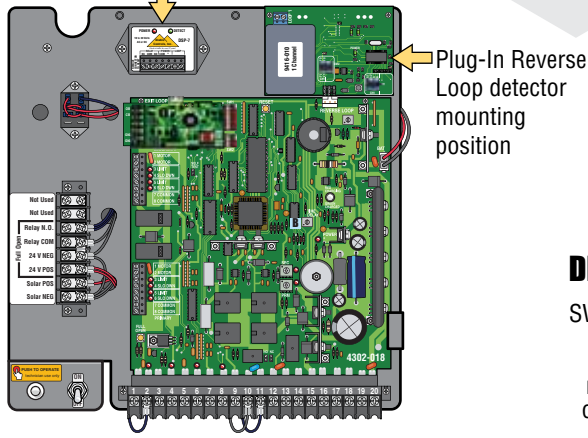
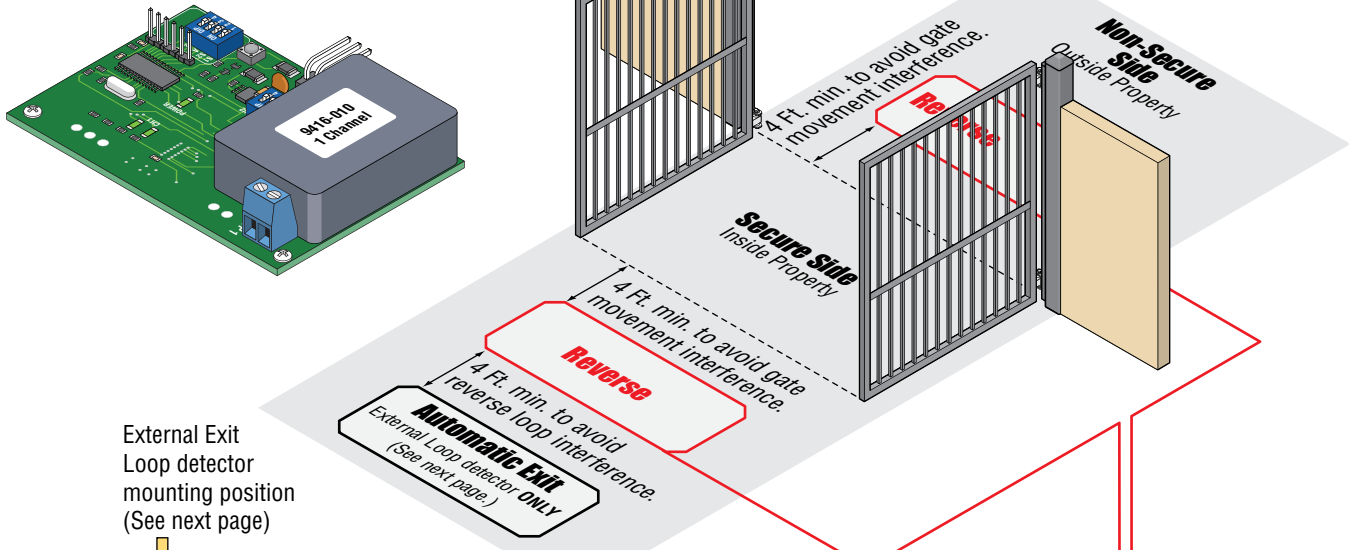

**Shadow Loop Note:**  
A shadow loop can **NOT** be wired to the solar control box.

**DoorKing Plug-In Low Current Draw Loop Detector 9416-010**

Note: See loop detector instruction sheet to set DIP-switches on detector.

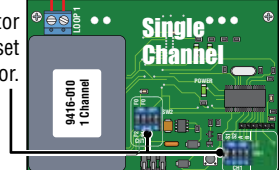

### DIP-Switch Settings

SW 1, switch 5 is **OFF**. Gate will reverse when obstruction is encountered.



**DO NOT USE EXIT LOOP PORT**

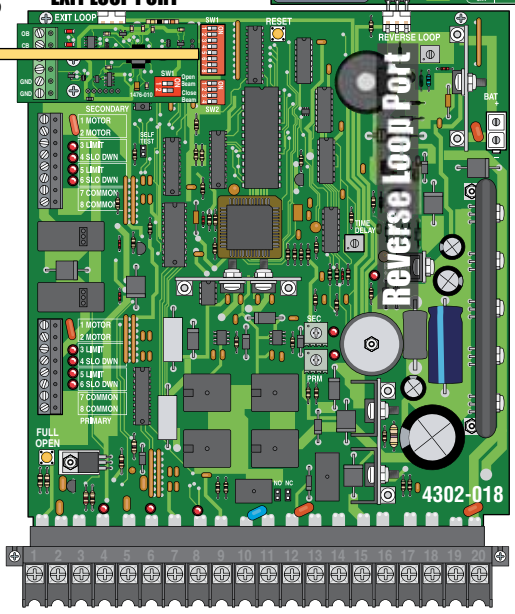

### Reverse Loops

Reverse loops prevent the gate from closing on a vehicle in or near the gate's swing pathway.

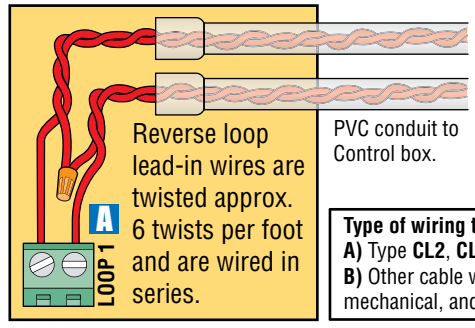

**Type of wiring to be used on ALL external devices:**  
A) Type CL2, CL2P, CL2R, or CL2X.  
B) Other cable with **equivalent** or **better** electrical, mechanical, and flammability ratings.

# 2.6 External Loop Detector Wiring

To help protect the operator from accidentally closing on vehicles in the gate's path, DoorKing highly recommends that loops and loop detectors are used. A loop detection system will sense a vehicle like a metal detector and send a signal to the gate operator preventing the gate from automatically opening or closing on a vehicle when it is in the gate's path. DoorKing recommends that a licensed installer perform this work.

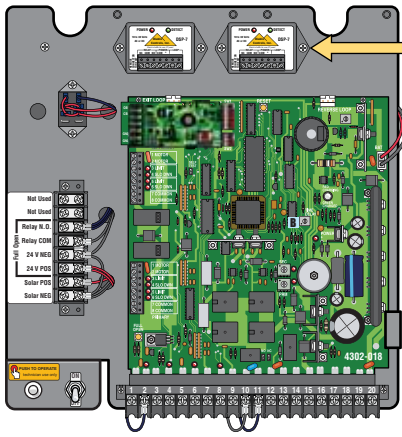

External Loop detector mounting position

**Shadow Loop Note:**  
A shadow loop can **NOT** be wired to the solar control box.

**Type of wiring to be used on ALL external devices:**  
**A) Type CL2, CL2P, CL2R, or CL2X.**  
**B) Other cable with equivalent or better electrical, mechanical, and flammability ratings.**

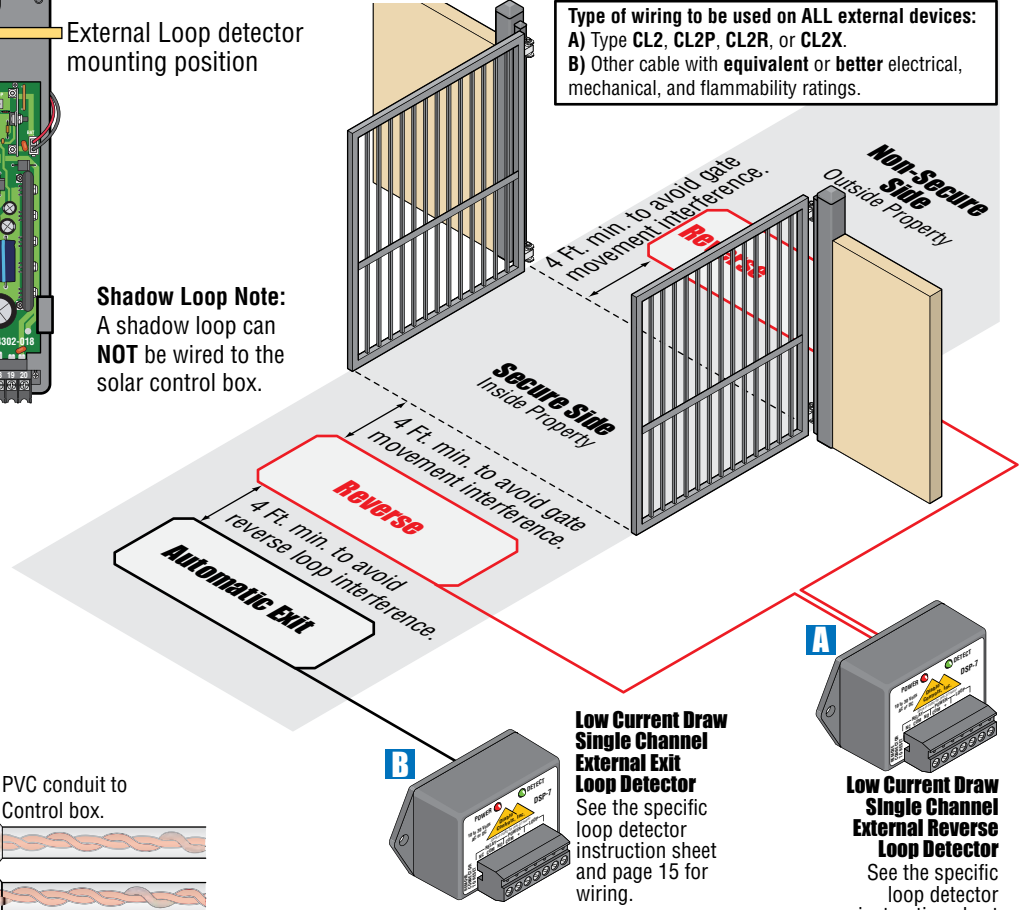

## Reverse Loops

Reverse loops prevent the gate from closing on a vehicle in or near the gate's swing pathway.

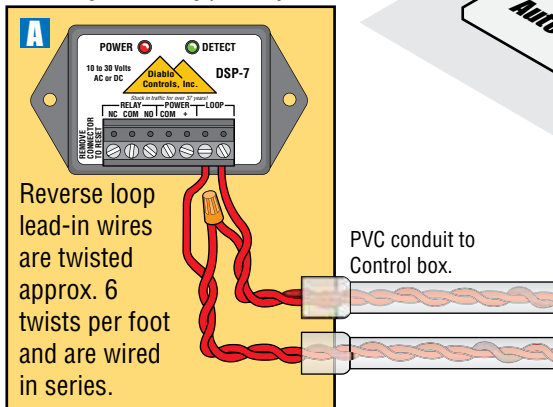

**Exit and Reverse Loops Note:** Low current draw external exit and reverse loop detectors can be used in place of the plug-in exit and reverse loop detectors to maintain power to these loops at all times.

**ANY loop detector used needs a relay contact time of AT LEAST 1 SECOND to bring circuit board out of "idle time" and operate gate.**

## Automatic Exit Loop

Automatically opens the gate for exiting vehicles without having to use a transmitter or key switch (Free exit).

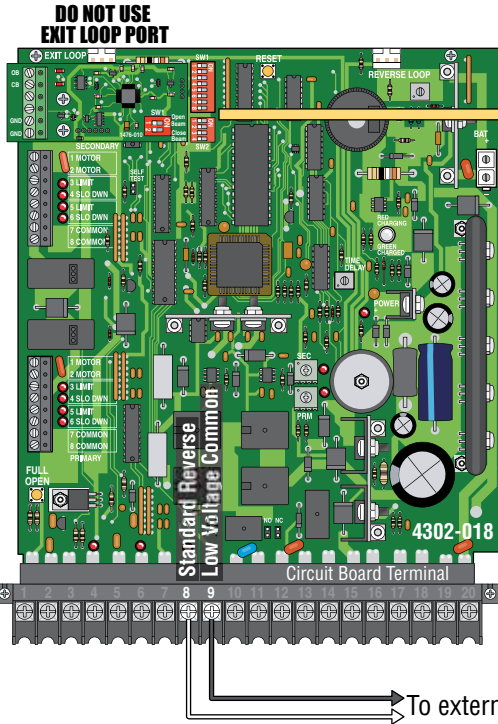
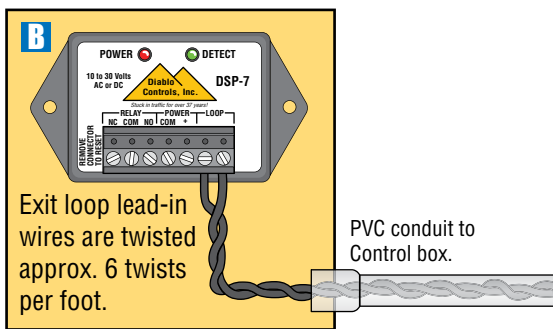

**SW 1, switch 5 is OFF.**  
Gate will reverse when obstruction is encountered.

## DIP-Switch Settings

**Reverse Loop Note:** Using a DKS Plug-In loop detector for the reverse loops **instead** of a external loop detector will allow **less** current draw during "Idle Time" saving battery life. See previous page.

## 2.7 Battery Wiring

**Temperatures** will affect the efficiency of the batteries. The batteries “optimal” operating temperature is approximately 77°F (25°C). They will not charge as quickly or cycle the gate operator as many times at lower temperatures. The lower the temperature is, the longer it will take for the batteries to fully charge and the fewer times the gate operator can be cycled before the batteries are drained. When batteries are continually operating at higher temperatures, they will wear out quicker. The higher the temperature is, the shorter the battery life.

**Clouds** will affect the efficiency of the batteries charging. The batteries “optimal” charging capacity is full sunlight. Charging time will vary depending on the density of the cloud cover and the amount of time that the cloud cover lasts. It will take the batteries longer to fully charge on cloudy days. Multiple cloudy days may not allow the batteries to get fully charged again after they have been drained resulting in the system not being able to cycle the gate until the sun returns.

### DoorKing Recommends:

**(2) Two 12 Volt 18 Amp/Hr batteries:** Use for applications with normal usage (60 cycles per day or less). P/N 1801-004

**(2) Two 12 Volt 35 Amp/Hr batteries:** Use for applications with higher usage (60 cycles per day or more). P/N 1801-005

12 Volt batteries smaller than 18 Amp/Hr are **NOT** recommended.

**DO NOT cycle the gate operator at this time.**  
Damage could occur to the gate and operator.

**Battery Replacement Note:** DoorKing **HIGHLY** recommends replacing the batteries every two years because of normal battery deterioration.

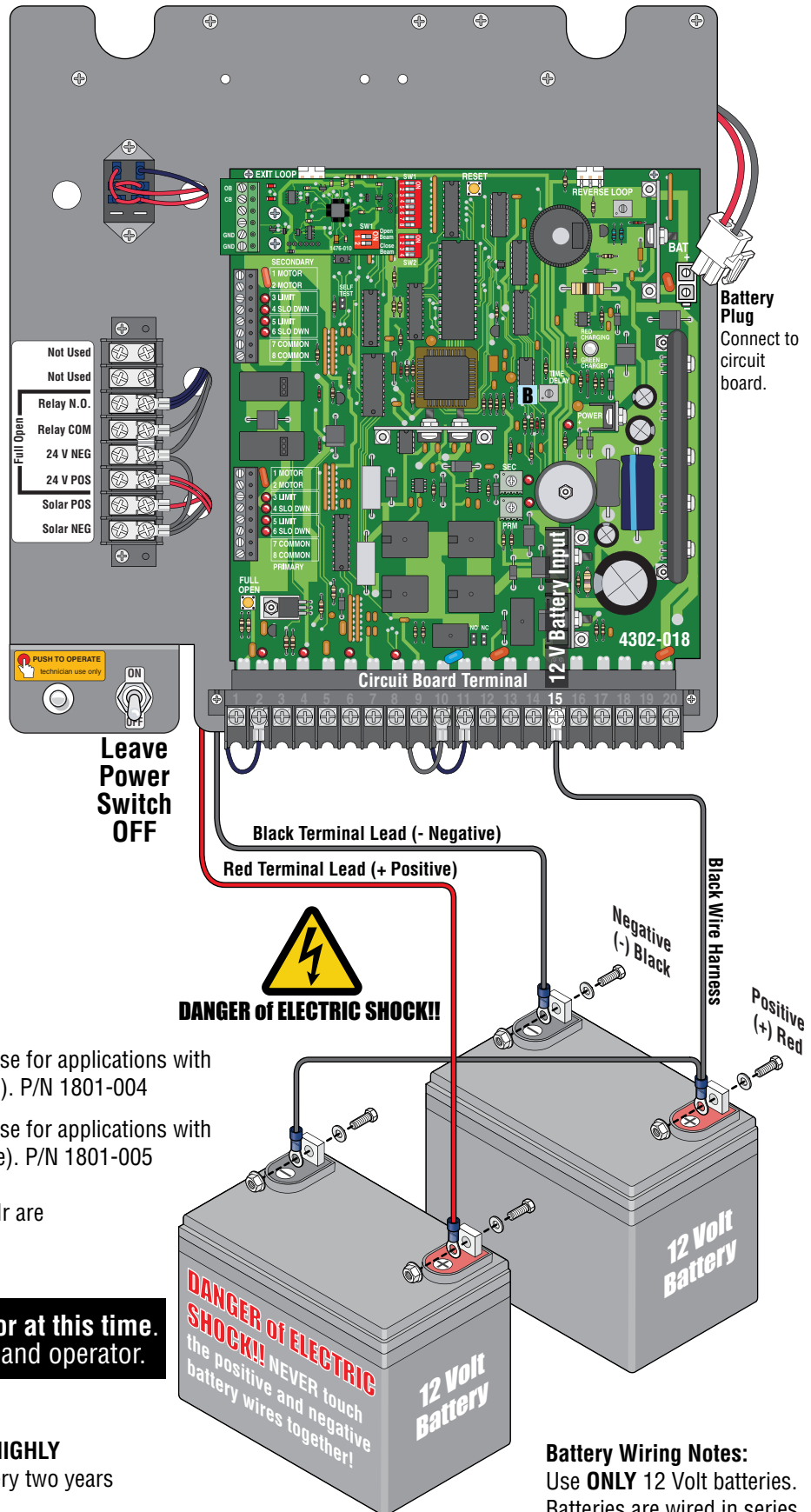

**Battery Wiring Notes:**  
Use **ONLY** 12 Volt batteries.  
Batteries are wired in series.





# SECTION 3 - ADJUSTMENTS

The switch settings and adjustments in this section should be made after your installation and wiring to the operator(s) is complete. **Whenever any programming or switch setting on the control board are changed, press the reset button for new settings to take effect.**

## 3.1 4302 Circuit Board Description and Adjustments

### DIP-Switches

Set DIP-switches on the circuit board to the desired setting. See switch-setting charts on next 2 pages.

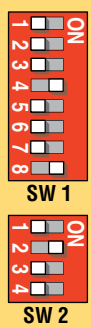

SW 1  
SW 2

### “Optional” External Loop Detectors

See 15 and 17.

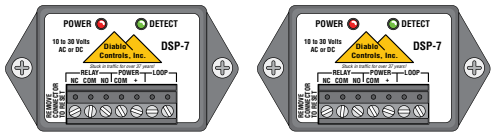

### How LEDs Function

 Illuminated LEDs indicates that low voltage power is being applied to the circuit board.

**Input LEDs** should be OFF and will only illuminate when the input wired to the corresponding main terminal is activated.

**Limit LEDs** will only illuminate when the respective limit sensor has been activated.

### “Optional” DKS Plug-In Loop Detector

See page 16.

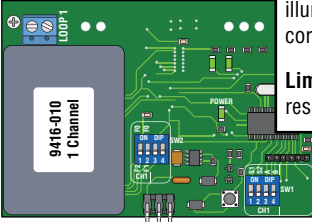

DO NOT USE EXIT LOOP PORT

### RESET



Press reset button to activate changed control board settings. Turns OFF activated alarm (See page 36).

### Self Test

Self test mode is for bench checks **ONLY**. The operator will continually cycle the gate.



Self Test Mode



Normal Mode

### Limit LEDs

See pages 23-25.

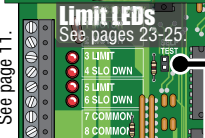

See page 11.

### Battery Plug

See page 18.

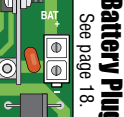

### FULL OPEN



Cycles the operator when pressed. Will use Auto-Close timer when turned ON. This switch **WILL NOT** function when there is **NO** power to the circuit board (Idle time).

### Auto-Close Timer

- Auto-close timer (when turned ON) SW 1, switch 4.

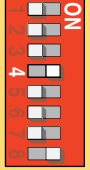

SW 1

Adjust from 1 second (full counter-clockwise) to approximately 23 seconds (full clockwise)

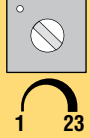

TIME DELAY

1 23

### Inherent Reverse Sensors

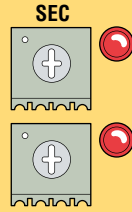

Adjust reversing sensitivity for: PRIMARY (single) and SECONDARY (dual) operators. See page 26.

Min Max Sensitivity

### 4302-018 Circuit Board Terminal



Used to power 8080-057 photocell. See page 12.

Used to wire external reverse loop detector. See page 15.



# 3.2 DIP-Switches

Whenever any programming or switch setting on the control board is changed, press the reset button for new settings to take effect.

## SW 1 - Top 8 Switches

Switch	Function	Setting	Description
--------	----------	---------	-------------

### Opening Direction of PRIMARY Operator

The operator **MUST OPEN GATE upon initial power up and OPEN command.**  
 If the operator closes gate after giving open command, shut off power and reverse this switch setting otherwise operator will **NOT** function correctly.

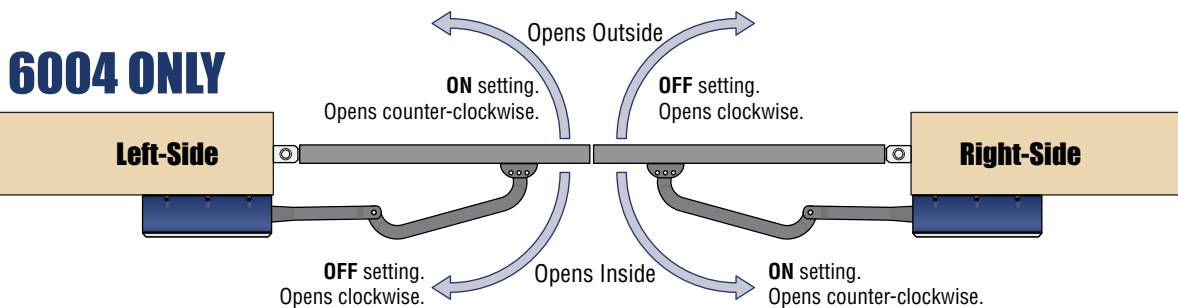

1

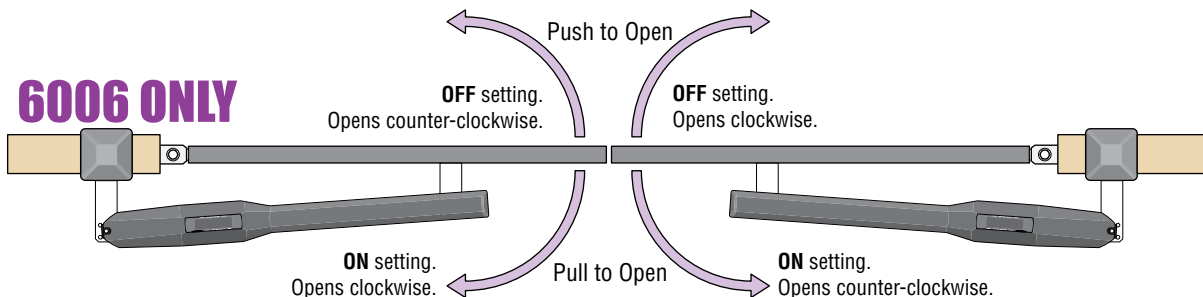

### 6400 ONLY

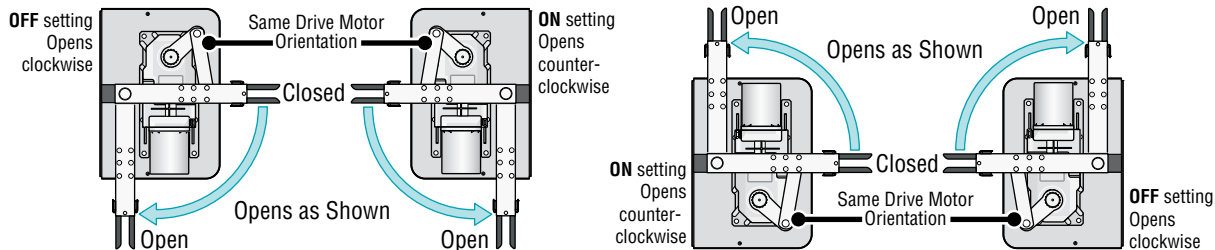

<b>2</b>	Opening Direction of <b>SECONDARY</b> Operator		Same opening directions as illustrated above for the primary operator type. <ul style="list-style-type: none"> <li>Switch 2 will be the <b>SAME</b> setting as switch 1 for the 6006.</li> <li>Switch 2 will be the <b>OPPOSITE</b> setting as switch 1 for the 6004 and 6400.</li> </ul> Note: SW 1, switch 7 <b>MUST</b> also be <b>ON</b> when using a secondary operator.
----------	--	--	---

SW 1 Switches continued on next page

## 3.2 DIP-Switches Continued

SW 1 (Top 8 Switches) continued

Switch	Function	Setting	Description
<b>3</b>	Not Used	OFF	Leave in the OFF position.
<b>4</b>	Auto-Close Timer	OFF	Auto-close timer is OFF. Manual input required to close gate.
		ON	Auto-close timer is ON. Adjustable from 1-23 seconds.
<b>5</b>	Reverse	OFF (normal)	Terminal #8 is a standard Reverse input.
	Not Used	ON	On setting is NOT used.
<b>6</b>	Overlapping Gates	OFF	Both operators start at the same time.
		ON	Secondary operator opens 1-2 seconds before primary operator. Vice-versa when closing.
<b>7</b>	Single	OFF	Switch must be OFF for single operator.
	Dual	ON	Switch must be ON when (dual) operators are used.
<b>8</b>	Input Power	ON	Switch MUST be in the ON position.

### SW 1 Switch Definitions:

**SW 1-Switch 1:** PRIMARY motor direction switch - **Must** OPEN the primary gate upon initial AC power up and open command. If the open command begins to close the primary gate, turn AC power off and reverse this switch.

**SW 1-Switch 2:** SECONDARY motor direction switch - **Must** OPEN the secondary gate upon initial AC power up and open command. If the open command begins to close the secondary gate, turn AC power off and reverse this switch.

**SW 1-Switch 3:** Not used, leave in the OFF position.

**SW 1-Switch 4:** Turns the auto-close timer on or off. Maximum time that the close timer can be set for is approximately 23 secs.

**SW 1-Switch 5:** OFF setting is Standard Reverse for a **CLOSING** gate. An input to terminal #8 (e.g.: N.O.-photo beam gets obstructed, **NOT** entrapment protection) **AND/OR** reverse loops get activated will stop and **reverse** the gate back to the full open position. If the auto-close timer is ON, when gate reaches the open position, timer **will not** close the gate. Another input command is needed to reset and close the gate. **DO Not** use the **ON** setting.

**SW 1-Switch 6:** When the gate overlap is **OFF**, the **DUAL** gate operators will start the open and close cycles at the **same time**. This is the normal setting for a **SINGLE** gate operator.

Turning the gate overlap **ON** when using dual gate operators will cause the secondary operator to start the **OPEN** cycle 1-2 seconds **before** the primary operator. The primary operator will start the **CLOSE** cycle 1-2 seconds **before** the secondary operator. This feature is useful when a magnetic lock is used to secure the gates.

**SW 1-Switch 7:** Sets up the circuit board for single or dual (Primary / Secondary) gate operation.

**SW 1-Switch 8:** Input power switch. Switch **MUST** be in the ON position for a solar control box. **DO NOT** turn switch OFF.

### SW 2 - Bottom 4 Switches

Switch	Function	Setting	Description
<b>1 and 2</b>	Relay Operation	1-OFF 2-ON	Circuit board relay activates when the gate is NOT closed.
<b>3</b>	Not Used	OFF	Leave in the OFF position.
<b>4</b>	Spare	OFF	Leave in the OFF position.

### SW 2 Switch Definitions:

**SW 2-Switch 1 and 2:** These work in conjunction with each other and will activate the relay on the circuit board **ONLY** when the gate is not closed. Switch 1 **MUST** be OFF and Switch 2 **MUST** be ON. **DO NOT** use any other switch combinations.

**SW 2-Switch 3:** Not used, leave in the OFF position.

**SW 2-Switch 4:** Spare switch. Leave in OFF position.

# 3.3 Limit Sensors Adjustment - Select your specific operator

The limit sensors on the operator **MUST** be adjusted to control the travel of the gate and to precisely set the **full open** and **full closed** position of the gate. **Use ONLY the limit sensor instructions for your SPECIFIC operator type (6004, 6006 or 6400).** This feature is especially useful in applications where the gate opens partially, such as on a curved driveway.

## 6004 Limit Switches ONLY

**Power to the circuit board must be ON when adjusting the limit sensors.**

The operator **MUST OPEN GATE** upon initial power up and **OPEN** command.

If the operator closes gate after giving first open command, shut off power and reverse DIP-switch SW1, switch 1 setting otherwise operator will **NOT** function correctly.

**A** With operator cover removed, un-lock operator with release tool to release arm.

**B** Manually move the gate to the desired open or closed position. Loosen adjustment screw and slowly spin the appropriate limit ring until the corresponding **LIMIT LED** on the circuit board lights up, then tighten screw. Manually move the gate to other position. Repeat process with the other limit ring.

**C** Re-lock operator with release tool and test the gate stopping positions. Re-adjust if necessary.

**D** Re-install the operator cover.

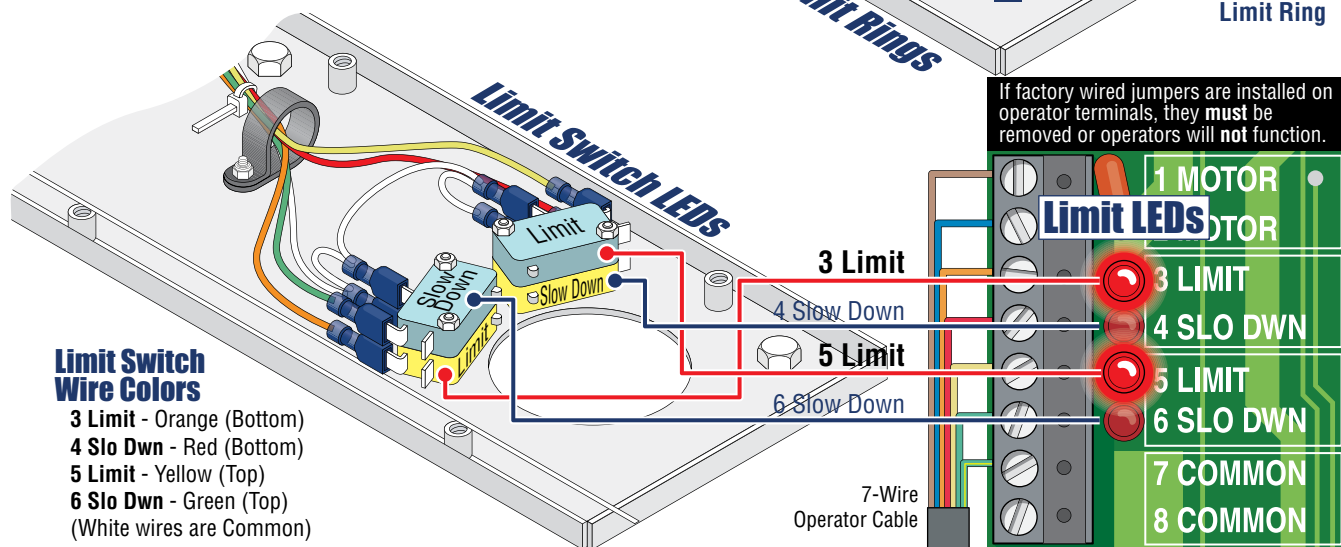
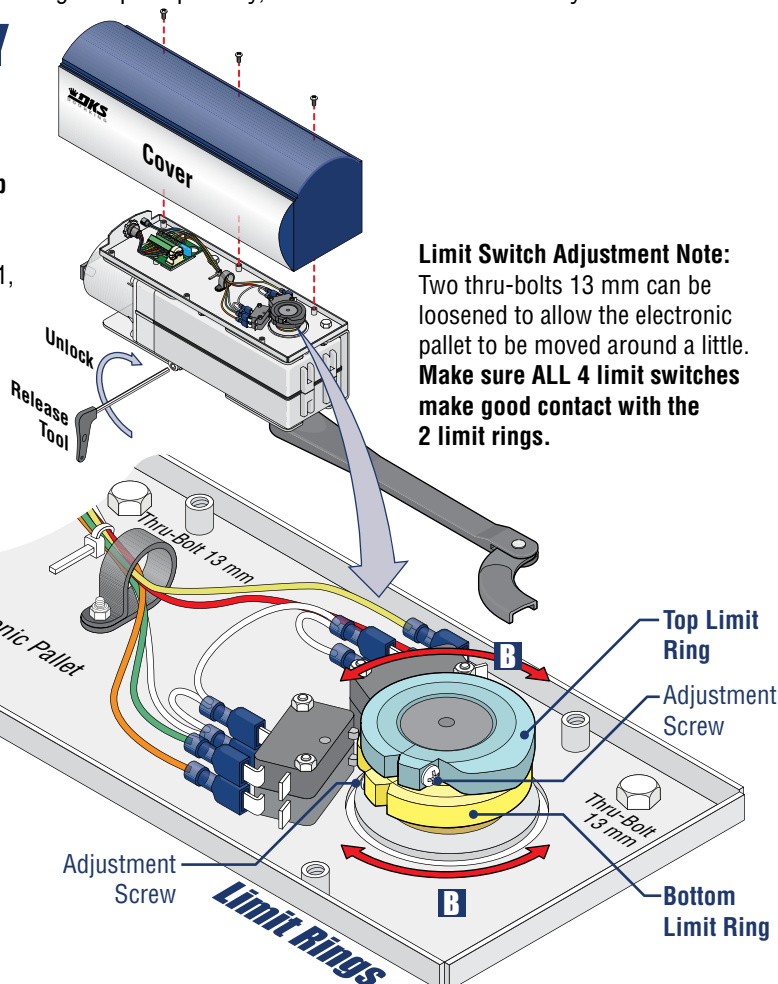

### Limit Switch Wire Colors

- 3 Limit - Orange (Bottom)
- 4 Slo Dwn - Red (Bottom)
- 5 Limit - Yellow (Top)
- 6 Slo Dwn - Green (Top)
- (White wires are Common)

**E** Adjust the Secondary operator limit rings if dual operators have been installed. DIP-switch SW 1, switch 2 controls secondary operator opening direction. DIP-switch SW 1, switch 7 **MUST** be ON when using dual operators. (See page 20)

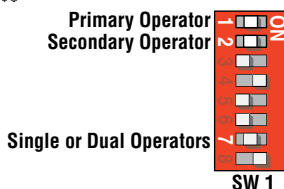

**Note:** 3 and 5 limit LEDs can be **Open** or **Close** limits depending on DIP-switch SW 1, switch 1 and 2 settings (See page 19)

## 3.3 Limit Sensors Adjustment Continued

### 6006 Limit Sensors ONLY

**Power to the circuit board must be ON when adjusting the limit sensors.**

**A** Manually unlock handle with key and rotate it 90°.

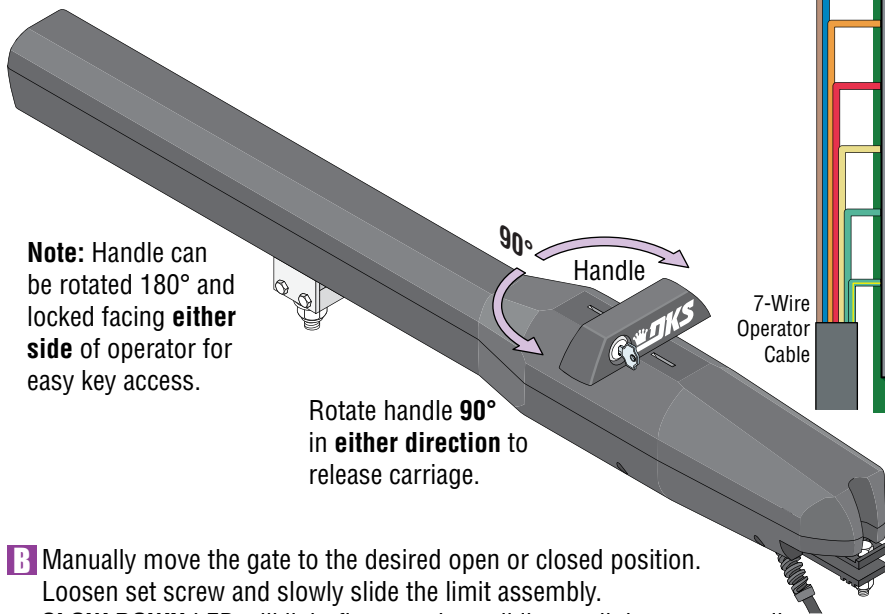

If factory wired jumpers are installed on operator terminals, they **must** be removed or operators will **not** function.

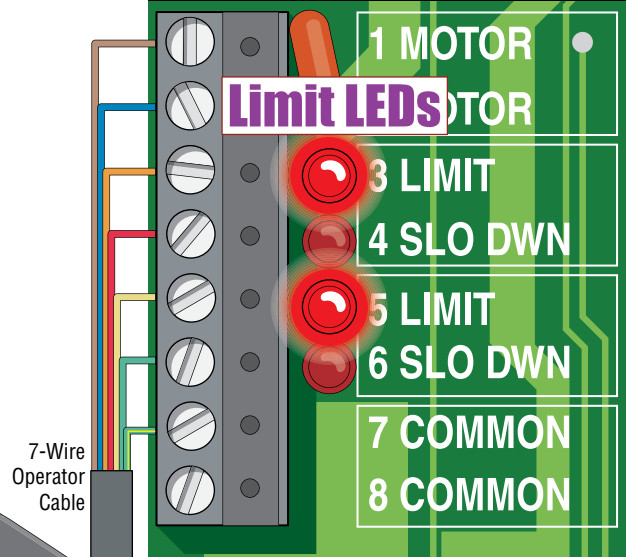

**Note:** 3 and 5 limit LEDs can be **Open** or **Close** limits depending on SW 1, switch 1 and 2 settings (See page 19).

**B** Manually move the gate to the desired open or closed position. Loosen set screw and slowly slide the limit assembly. **SLOW DOWN** LED will light first, continue sliding until the corresponding **LIMIT LED on the circuit board lights up**. Tighten screw. Manually move the gate to other position. Repeat process with the other limit assembly.

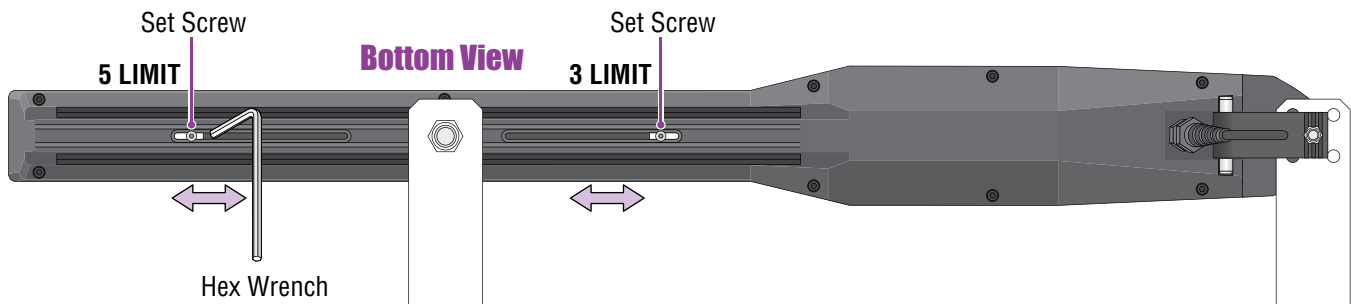

**C** Rotate handle back 90° and re-lock it. Test the gate stopping positions. Re-adjust if necessary.

**D** Adjust the secondary actuator limit sensors if dual actuators have been installed. DIP-switch SW 1, switch 2 controls secondary actuator opening direction. DIP-switch SW 1, switch 7 **MUST** be ON when using dual actuators (See page 20).

**IMPORTANT: The operator MUST OPEN GATE upon initial power up and OPEN command.**

If the operator closes gate after giving first open command, shut off power and reverse DIP-switch SW1, switch 1 setting otherwise operator will **NOT** function correctly.

# 3.3 Limit Sensors Adjustment Continued

## 6400 Limit Sensors ONLY

**Power to the circuit board must be ON when adjusting the limit sensors.**

**A** With operator cover plate removed, un-lock release handle and pull handle to release gate.

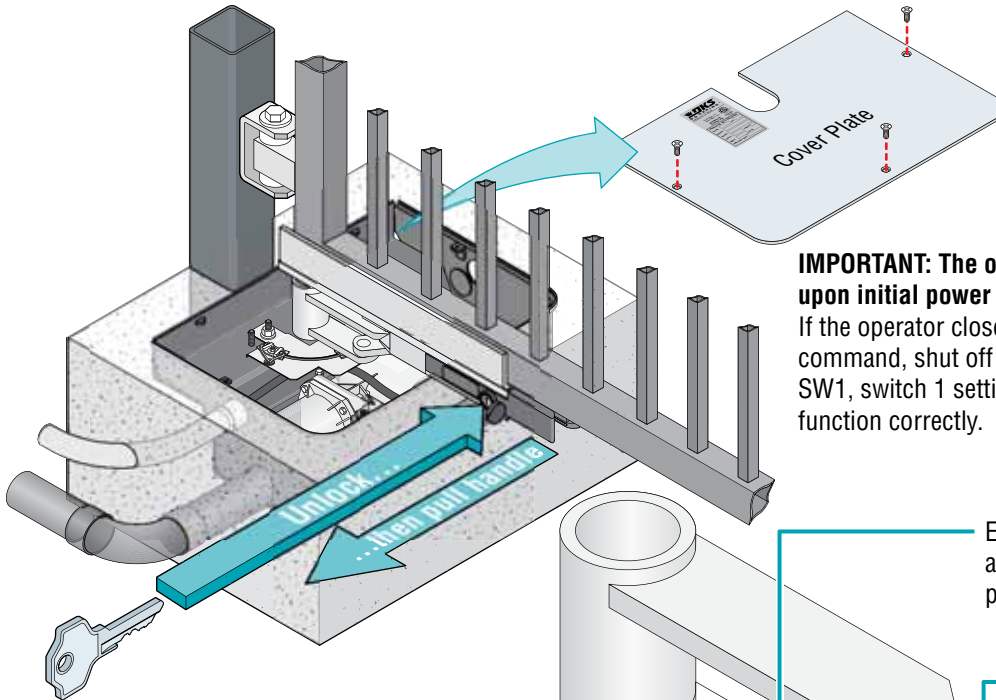

**IMPORTANT: The operator MUST OPEN GATE upon initial power up and OPEN command.**  
If the operator closes gate after giving first open command, shut off power and reverse DIP-switch SW1, switch 1 setting otherwise operator will **NOT** function correctly.

**B** Manually move the gate to the desired open or closed position. Loosen limit nut and slowly slide the limit assembly until the corresponding **LIMIT** LED on the circuit board lights up and tighten nut. Manually move the gate to other position. Repeat process with the other limit assembly.

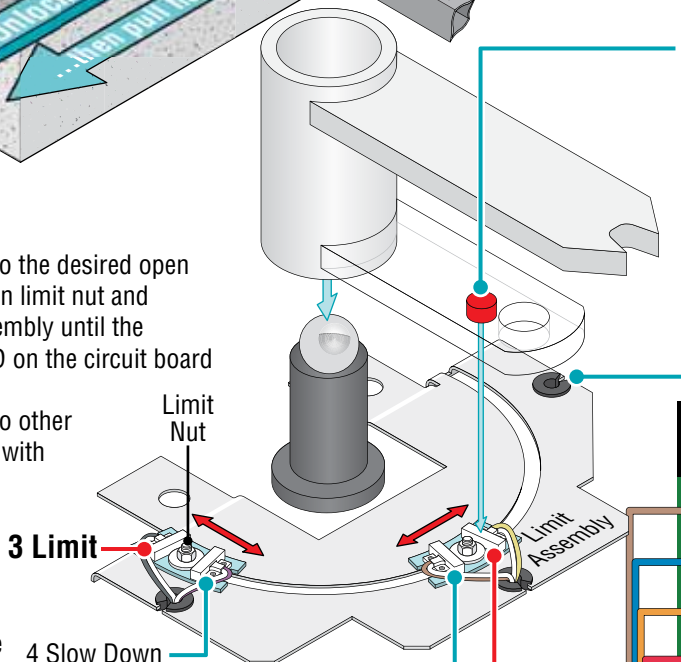

Embedded magnet on underside activates limit sensors when it passes over them.

Limit assembly positions may vary depending on the operator's drive motor orientation. Limit sensor wire color LEDs remain the same.

**C** Re-lock release handle with key and test the gate stopping positions. Re-adjust if necessary.

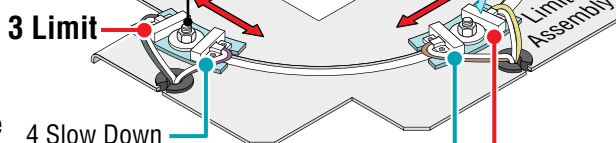

### Limit Sensor Wire Color LEDs

- 3 Limit LED - Gray/White
- 4 Slo Dwn LED - Purple/White
- 5 Limit LED - Yellow/White
- 6 Slo Dwn LED - Brown/White

**D** Re-install the operator cover plate.

**E** Adjust the Secondary operator limit sensors if dual operators have been installed. DIP-switch SW 1, switch 2 controls secondary operator opening direction. DIP-switch SW 1, switch 7 **MUST** be ON when using dual operators. (See page 21)

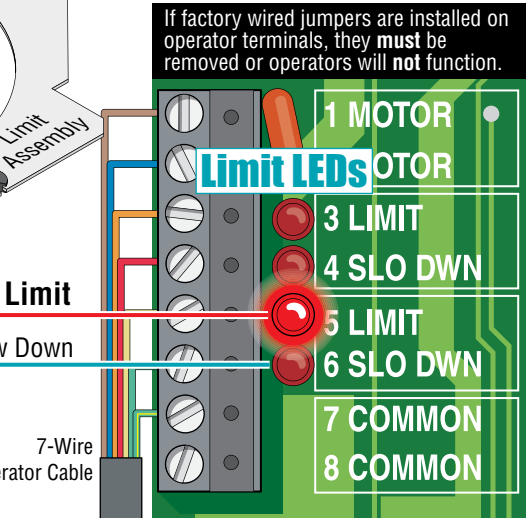
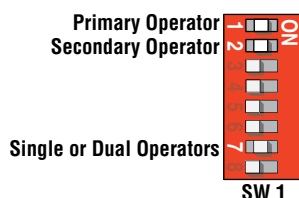

If factory wired jumpers are installed on operator terminals, they **must** be removed or operators will **not** function.

**Note: 3 and 5 limit LEDs can be Open or Close limits depending on DIP-switch SW 1, switch 1 and 2 settings. (See page 21)**



## 3.4 Inherent Reverse Sensor Adjustment

This vehicular gate operator is equipped with an inherent (Built-In) adjustable reversing sensor (Type A) that is used as an entrapment sensing system according to the UL 325 standards. The gate will reverse direction upon encountering an obstruction in either the **opening or closing gate cycle**. For the reverse system to function correctly, the gate must be properly installed and work freely in both directions. A good set of roller bearing hinges is essential for proper swing gate operation.

The ideal adjustment will allow the operator to move the gate through its entire travel cycle without reversing, but will reverse upon contact with an obstruction with no more than 40 Lbs of force. This force can be measured with a gate scale.

The amount of force required for the gate to reverse direction depends on the reverse sensitivity potentiometer.

### Adjust the operators reversing sensitivity:

**CAUTION:** Keep pedestrians and vehicles clear of the gate while adjusting and testing sensors!

#### While operator has power:

- 1 Press the “Push to Operate” button to **OPEN** the gate.

Note: “Push to Operate” button will use the Auto-Close timer if turned ON (SW 1, switch 4 **ON**).

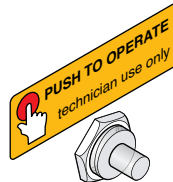

- 2 While gate is opening, slowly rotate PRM - **Primary** reverse sensor clockwise until the **reverse LED lights up** and the gate reverses direction. Rotate the primary reverse sensor back counter-clockwise approximately 1/8 turn to decrease the sensitivity (LED will turn off).

Note: The LED will light up during the first seconds of gate travel. Wait until it turns off before adjusting the reverse sensor.

- 3 Press the “Push to Operate” button (or wait for Auto-Close timer to time-out if turned ON) and **CLOSE** the gate. Make sure the gate closes completely. If it reverses and opens (LED will light up), rotate the primary reverse sensor counter-clockwise a little more to decrease the reverse sensitivity (LED will turn off). Cycle the gate a few times to be sure that it cycles completely in **BOTH** directions, re-adjusting the primary sensor as necessary.

#### Dual Operators:

Secondary operator must be individually adjusted if dual operators have been installed. Use the **SEC - Secondary** reverse sensor.

#### Test the operators reversing sensitivity:

Place an immobile object along the gate path, allowing the gate to strike it while in the **open** or **close** cycle. The gate must reverse direction after striking the object. If it does not, increase the reverse sensitivity (steps **2** and **3**) and repeat this test until the correct sensitivity has been set for the **OPEN** and **CLOSE** directions.

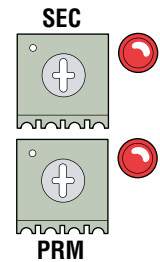

Note: The LED will turn on briefly when power is turned on.

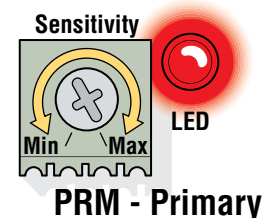

**Safety Note:** The LED will remain ON after a cycling gate gets obstructed during **normal** operation to indicate that the reverse sensor has been tripped. Always check the gate area for possible obstructions before putting operator back in service.

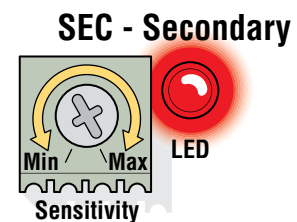



## 3.5 “Optional” Radio Receiver Model (8040-080)

The 8040-080 receiver operates at 318 MHz and **MUST** be used with either the DoorKing MicroPlus® OR MicroClik® transmitters (Sold Separately).

### MicroPlus® Transmitters (Sold Separately)

Over 286,000,000 transmitter codes available plus an encrypted sync code (often called a “rolling code”) that changes every time the transmitter is used. Available in 1 – 2 – 3 – 4 button versions. MicroPlus® transmitter codes cannot be copied assuring that only the original intended transmitters will activate the access control system.

As such, MicroPlus® transmitters are **NOT compatible** with the HomeLink® system found in many automobiles.

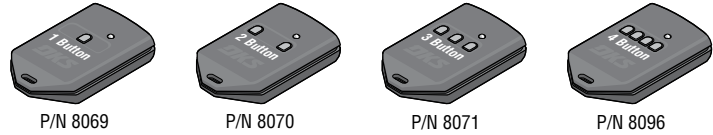

MicroPlus® Transmitters

### MicroClik® Transmitters (Sold Separately)

Over 1,000,000 transmitter codes available. Available in 1 – 2 – 3 button versions. MicroClik® transmitters **ARE compatible** with the HomeLink® system found in many automobiles.



MicroClik® Transmitters

### Quick Setup for a MicroPlus® Transmitter (Sold Separately)

The DoorKing MicroPlus® transmitter can be quickly learned if desired. The MicroPlus® type transmitter is the factory default setting for this receiver and can be quickly setup with minimal programming.



1. Turn the Program Selector to **Position 1**.

2. Press and **HOLD** Program Button until the Program LED flashes **ONCE** and receiver will BEEP once. Receiver is now in “**Learn Mode**” and will flash and beep for 10 seconds.

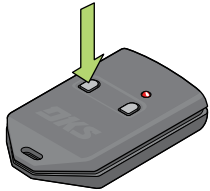

3. Press a **specific** button on the MicroPlus® transmitter to be “**Learned**” within 10 seconds, wait for the receiver to time-out. MicroPlus® transmitter can now operate the gate.

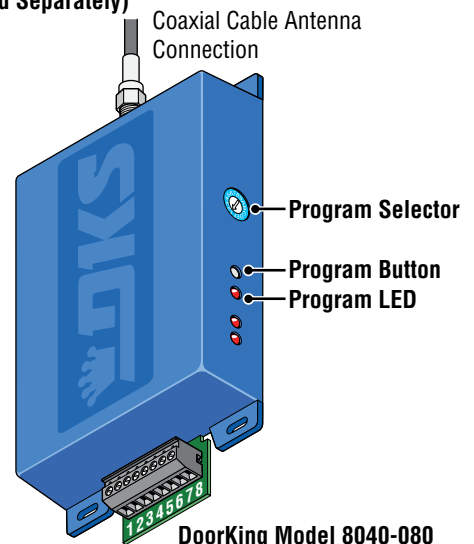

### Setup for a MicroClik® Transmitter (Sold Separately)

The 8040-080 receiver **MUST** be changed to MicroClik® mode before learning a MicroClik® transmitter.

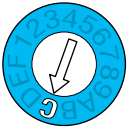

1. Turn the Program Selector to **Position C**.

2. Press and **HOLD** Program Button until the Program LED flashes **ONCE** and receiver will BEEP once. Press and hold button **again**, LED will flash and receiver will beep. Press and hold button **a third time** until LED continually flashes and beeps.

**Note:** If receiver does not emit a continuous beep after pressing the button 3 times, try repeating this step faster or slower until it does.

3. Turn power OFF, then back ON. Receiver will BEEP **TWICE** for MicroClik® mode. (Three times for MicroPlus® mode) See next page to check receiver mode.

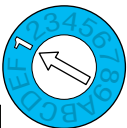

4. Turn the Program Selector to **Position 1**.

5. Press and **HOLD** Program Button until the Program LED flashes **ONCE** and receiver will BEEP once. Receiver is now in “**Learn Mode**” and will flash and beep for 10 seconds.

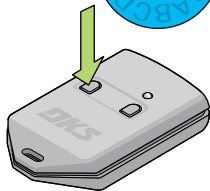

6. Press a **specific** button on the MicroClik® transmitter to be “**Learned**” within 10 seconds, wait for the receiver to time-out. MicroClik® transmitter can now operate the gate.

## 3.5 Radio Receiver Continued

### Check if Receiver is set for MicroPlus® or MicroClik® Mode

1. Turn receiver's power OFF then back ON.
2. Receiver will BEEP **TWICE** for MicroClik® mode. Receiver will BEEP **THREE times** for MicroPlus® mode (Factory Setting).

If you need to change the receiver's mode, follow the steps below.

**CAUTION:** Changing an **EXISTING** programmed receiver from one mode to the other will erase **ALL EXISTING MEMORY** that has been previously programmed in the receiver. **This cannot be UNDONE.**

### Change Receiver Mode - MicroPlus® or MicroClik®

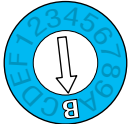

- 1A. Turn the Programming Selector to “**Position B**” will change to MicroPlus® mode.

OR



- 1B. Turn the Programming Selector to “**Position C**” will change to MicroClik® mode.

2. Press and hold Program Button until the Program LED flashes **ONCE** and receiver will BEEP once. Press and hold button **again**, LED will flash and receiver will beep. Press and hold button a third time until LED continually flashes and beeps.  
**Note:** If receiver does not emit a continuous beep after pressing the button 3 times, try repeating step 2 faster or slower until it does.
3. Turn power OFF, then back ON. Receiver will BEEP twice for MicroClik® mode (1B) or three times for MicroPlus® mode (1A).

### Learn Master Transmitters (Up to 4 Transmitters)

Up to 4 **Master** transmitters can be created to quickly program new transmitters in the future.

After programming is complete for a master transmitter's button, when that desired button is pressed, it puts the receiver into “**Learn Mode**” for that button. New transmitters can then be programmed in. Press each **NEW** transmitter's desired button within a 10 sec. time period to have receiver learn new transmitters. Wait for receiver to time out (10 sec) when finished.

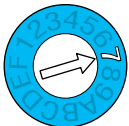

1. Turn the Programming Selector to “**Position 7**”.

2. Press and hold Program Button until the Program LED flashes **ONCE** and receiver will BEEP once. Receiver is now in “**Learn Mode**” and will flash and beep every second for 10 seconds.
3. Press the button on the master transmitter to be “**Learned**” within 10 seconds. Receiver will reset 10 second timer after each master transmitter button has been pressed.
4. Press other master transmitter buttons to be learned, each within a 10 second time period.
5. After all desired master transmitters have been learned by the receiver (up to 4 total), wait for the receiver to time-out.

**Note:** Keep master transmitters in a secure place.

### Erase ALL Memory - This CANNOT be UNDONE



1. Turn the Programming Selector to **Position A**.

2. Press and hold Program Button until the Program LED flashes **ONCE** and receiver will BEEP once. Press and hold button **again**, LED will flash and receiver will beep again. Press and hold button **a third time**, LED will flash and receiver will beep a third time.
3. The receiver will then emit a long flash and long beep indicating **ALL memory**, including master transmitters have been erased from memory.

**Note:** If receiver does not emit a continuous beep after pressing the button 3 times, try repeating step 2 faster or slower until it does.

Continued on next page.

## 3.5 Radio Receiver Continued

### Set to LOW - Power Mode

The receiver can be changed from normal-power to **LOW-Power mode**. LOW-power mode is used in DoorKing solar gate operator applications. Wiegand output will **NOT** work in LOW-Power mode.

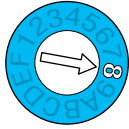

1. Turn the Programming Selector to “**Position 8**”.

2. Press and hold Program Button until the Program LED flashes ONCE and receiver will BEEP once.
3. Receiver LED will then give a long flash and beep.
4. This indicates receiver is in LOW-Power mode which consumes **LESS** power than NORMAL-Power mode.

For complete advanced programming features for the **8040 radio receiver**, go to DoorKing’s web site for MicroCLik® RF Controls **OR** MicroPlus® RF Controls to download the **8040-065** instruction sheet for the **8040** under technical downloads.

## 3.6 Shutdown Conditions

Under various entrapment conditions the operator will assume either a **SOFT** or **HARD (alarm)** shutdown. To determine what type of reset action is required, you will need to understand how the different entrapment conditions affect the gate operator.

### Soft Shutdown

This occurs in various situations where the inherent or external entrapment protection devices have been activated. In a soft shutdown condition, the operator **will not** respond to any input that was present when the entrapment protection device sensed or encountered an obstruction. If the gate stops at the open position, the operator **will not** respond to the automatic close timer and a “manual input” is required to close the gate.

- **Example 1** - A time clock keys the gate open in the morning and an entrapment protection device senses an obstruction prior to the gate reaching the full open position. If the entrapment is sensed by the inherent system, the gate will reverse and run back to the closed position. The time clock input is still present, but the gate will not re-open.

**Note:** In some systems, the time clock input comes from the telephone entry system relay. This same relay may also provide open commands for a card reader, MicroPLUS transmitters and the visitor telephone entry. If so, these devices will also be disabled in a soft shutdown condition.

- **Example 2** - If the gate is closing and an entrapment protection device is activated, the gate will either stop or reverse and run back to the open position, depending upon if the external or inherent device was activated. The automatic close timer will not close the gate.
- **Example 3** - If a moving vehicle runs over a loop while the gate is cycling open and hits the opening gate, the operator’s inherent entrapment protection is activated. The gate will reverse direction and run back to the closed position. A soft shutdown condition **does not occur** and the loop provides an immediate reset of the operator. Once the loop area is clear and another open command is given, the gate will cycle open.

### Resetting a Soft Shutdown

In some conditions, a soft shutdown will reset as soon as the entrapment condition clears. For example, if a non-contact sensor (photo sensor) is sensing an obstruction, the operator will stop the gate and assume a soft shutdown condition. When the photo sensor clears (Obstruction is no longer there), the operator will return to normal operation. When the operator is in a soft shutdown, activation of any “intended input” will reset the operator. An “intended input” includes any command input device, any standard safety input device and any loop input. Activating any of these inputs will reset the gate. At that point the gate will return to normal operation. If the gate is open, the automatic close timer will then time out and close the gate.

**When the operator is in a soft shutdown, the system WILL NOT shut down power to the circuit board until an “intended input” has been activated regardless of the length of time it takes to accomplish this (See the paragraph above).**

Continued on next page.

## 3.6 Shutdown Conditions Continued

### Hard Shutdown (Alarm Activated)

A hard shutdown condition occurs when: (1.) The inherent entrapment protection system (Type A) gets activated **TWO** consecutive times before the gate completes the open or close cycle. (2.) The reversing edge (Type B2) gets activated and reverses but before the gate completes the reverse cycle the inherent entrapment protection system (Type A) gets activated.

- **Example of a Hard Shutdown** - The gate is closing and the inherent entrapment protection system senses an obstruction and causes the gate to reverse direction. As the gate begins to run in the open direction, a second obstruction is sensed prior to the gate reaching the full open position. Once the second obstruction has been sensed, the operator will stop, **the audio alarm will sound and all standard inputs are shut down** (including open commands, safety commands, loop inputs, etc.).
  - **To silence the alarm**, press the reset button or after 5 minutes, the audio alarm will shut off but will “chirp” every 5 seconds. This indicates that the operator is in a hard shutdown condition (The reset button must be pressed **OR** turn power off to reset the operator and stop the alarm “chirping”).

### Resetting a Hard Shutdown

The operator is in a hard shutdown condition when the audio alarm is sounding OR “chirping” every 5 seconds.

- Before resetting a hard shutdown, determine why the shutdown occurred. Inspect the gate for any obstructions along its path that could have activated the inherent entrapment sensing system. Inspect the gate and gate hardware. If the gate is malfunctioning, **DO NOT** put it back into service until the problem can be corrected.

**The audio alarm will sound for five minutes if the operator is not reset. After (5) five minutes the alarm will “chirp every 5 sec.” and the hard shutdown condition will remain in affect until the reset button is pushed OR power is shut-off to operator.**

### Shutting OFF Alarm

DoorKing operators have a built-in alarm reset push button on the circuit board. Activating this button will return the gate operator to normal operation, but **will not** activate the gate operator. Also, power can be shut-off to the gate operator to reset it.

When the operator is in a hard shutdown, the system **WILL NOT** shut down power to the circuit board (idle time) until the reset button has been activated regardless of the length of time it takes to accomplish this.

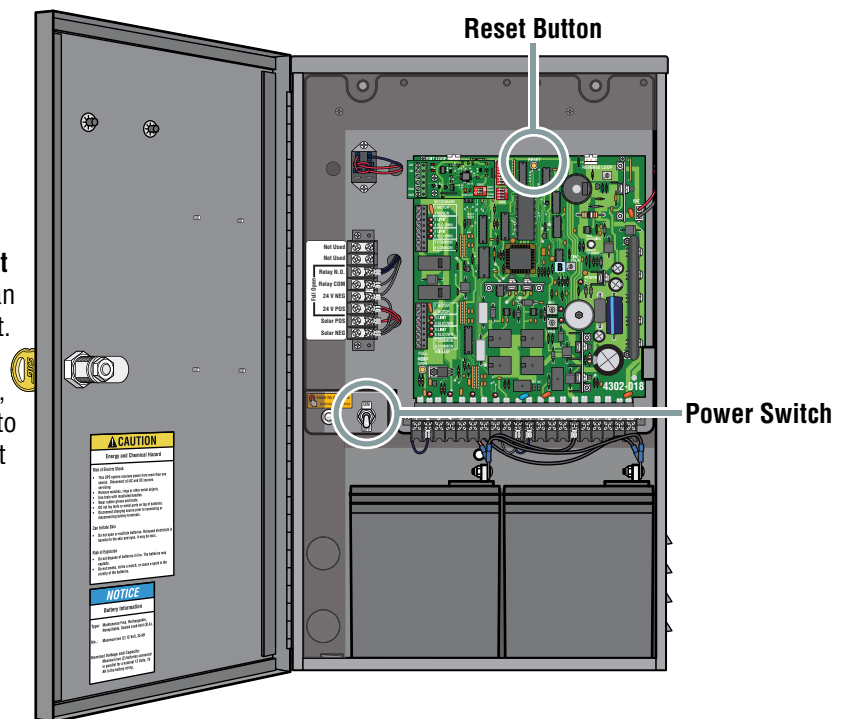

Once the gate has been reset, an open or close command is needed to start the gate operator. Most activating commands will cause the gate operator to cycle to the open position. This includes activation of a key switch or open command and activation of the automatic exit loop (If used). Activation of a close command will run the gate to the closed position.

# SECTION 4 - MAINTENANCE AND TROUBLESHOOTING

Inspection and service of this gate operator by a qualified technician should be performed anytime a malfunction is observed or suspected. High cycle usage may require more frequent service checks.

## 4.1 Maintenance

When servicing the gate operator, always check any external reversing devices (loops, photo sensors, etc.) for proper operation. If external reversing devices cannot be made operable, do not place this operator in service until the malfunction can be identified and corrected.

**Always check the inherent reversing system when performing any maintenance. If the inherent reversing system cannot be made operable, remove this operator from service until the cause of the malfunction is identified and corrected. Keeping this operator in service when the inherent reversing system is malfunctioning creates a hazard for persons which can result in severe injury or death should they become entrapped in the gate.**

When servicing the gate operator, be sure that the power switch is turned OFF.

Operator Component	Maintenance	Monthly Interval		
		1	6	12
<b>Warning Signs</b>	Check that warning signs are on BOTH sides of the gate area.	✓		
<b>Alarm</b>	Activate the primary (inherent) reverse system by blocking the gate with a solid object. When the gate reverses, block the gate in the opposite direction prior to the limit being reached. The entrapment alarm should activate. Press the reset button or turn power off to silence the alarm.	✓		
<b>Batteries</b>	Check the batteries for any leakage or loose connections. Batteries should be replaced every two years.	✓		
<b>Solar Panel</b>	Check the panel for any debris on it. Clean the panel with water.	✓		
<b>Fire Dept.</b>	Check emergency vehicle access device for proper operation.	✓	✓	
<b>Gate</b>	Inspect for damage. Check gate hinges for wear and grease if necessary.		✓	
<b>Primary Reverse System</b>	Check that the gate reverses on contact with an object in both the opening and closing cycles. Adjust the reversing sensor if necessary. See page 38	✓		
<b>Loop(s)</b>	Check vehicular reverse loops for proper operation.	✓		
<b>Manual Release</b>	Check manual release for proper operation. See page 37	✓		
<b>External Entrapment Device</b>	Check external reverse device(s) stop or reverse the gate when activated. See page 38	✓		
<b>Complete System</b>	Complete check of gate and gate operating system.			✓

## 4.2 Diagnostics Check

Have the following diagnostic tools available: VOM meter with minimum voltage memory or min-max range to check voltage and continuity. Meg-ohm meter capable of checking up to 500 megohms of resistance to properly check ground loop integrity. A malfunction can be isolated to one of the following:

- Gate Operator
- Loop System
- Keying Devices.

**Disconnect all external inputs to the circuit board.**

1. Check the input indicator LED's. They should only come ON when a keying device (card reader, push button, etc.) is activated. If any of the input LED's are ON continuously, this will cause the gate operator to hold open. Disconnect the keying devices one at a time until the LED goes OFF (see troubleshooting guide).
2. If the operator stops or holds open, check external entrapment protection devices for any shorts or malfunction.
3. A malfunction in a loop or loop detector can cause the gate operator to hold open, or not detect a vehicle when it is present over the loop. Pull the loop detector circuit boards from the loop ports on the operator circuit board. If the malfunction persists, the problem is not with the loop system. For more information refer to the loop detector instruction sheet and the DoorKing Loop and Loop Detector Information Manual. Continued on next page.

## 4.2 Diagnostics Check Continued

4. Check that there are no shorted or open control wires from the keying devices to the gate operator. If a keying device fails to open the gate, momentarily jumper across terminals 1 and 2 on the control board. If the gate operator starts, this indicates that a problem exist with the keying device and not with the gate operator.

5. Check the supply voltage and batteries. A voltage drop on the supply line (usually caused by using too small supply voltage wires) will cause the operator to malfunction. Batteries should be fully charged for proper operation, replace batteries every two years on average.

## 4.3 Troubleshooting

Symptom	Possible Solution(s)
Operator(s) will not run. Power LED is OFF.	<ul style="list-style-type: none"> <li>• Check that AC power to the operator is turned ON.</li> <li>• Check that <b>ANY</b> access control device wired to operator (radio receiver, key switch, exit loop or safety opening device) has a relay contact time of <b>AT LEAST 1 SECOND</b> to bring the circuit board out of "idle time" and operate gate.</li> <li>• Check battery</li> <li>• Check for 24 VAC at terminals 19 and 20. If voltage measures OK, check the terminal strip or replace the circuit board.</li> </ul>
Operator(s) will not run. Power LED is ON.	<ul style="list-style-type: none"> <li>• Insure that a minimum of one (1) external entrapment protection device is connected in <b>EACH</b> entrapment area and the inputs are connected and enabled (UL 325 DIP-switches are turned ON).</li> <li>• Momentarily jumper terminal 1 to terminal 2. If the input LED does not come ON, check the terminal strip or replace the circuit board. If LED does come ON, proceed to next steps.</li> <li>• Check the fuses.</li> <li>• <b>Check Motor(s):</b> Remove the circuit board. With two 14 AWG insulated jumper wires, momentarily jumper the battery terminals to the motor terminals (1, 2) of the Primary operator connector. The operator should run. Swap the two wires at the terminal strip. The operator should run in the opposite direction. Repeat these steps using the Secondary operator connector.</li> <li>• If the operator(s) run in both directions in the step above, replace the control board. If the operator(s) do not run, or run in only one direction, problem can be a bad operator, wire connections from the control board to the operator(s) or a bad control board.</li> </ul>
Operator will not run, entrapment protection input(s) LED is ON.	<ul style="list-style-type: none"> <li>• The entrapment protection device has a fault or the wiring to it is shorted.</li> </ul>
Operator will not run, entrapment protection input(s) LED is Blinking.	<ul style="list-style-type: none"> <li>• The entrapment protection device is not connected or the wiring to it is open.</li> </ul>
Gate opens a short distance, then stops and reverses.	<ul style="list-style-type: none"> <li>• Check the reversing sensitivity.</li> <li>• Check the secondary safety devices.</li> <li>• Disconnect the gate from the gate operator and check that the gate swings freely without any binding.</li> <li>• Continue troubleshooting or replace the circuit board.</li> </ul>



## 4.3 Troubleshooting Continued

Symptom	Possible Solution(s)
Gate opens but will not close.	<ul style="list-style-type: none"> <li>• Check the input LEDs. Any ON will hold the gate open and indicates a problem with a keying device.</li> <li>• Check the secondary safety devices. Any activated will hold the gate open and indicates a problem with the safety device.</li> <li>• Check the loop detectors. Any activated can hold the gate open and indicates a problem with the loop detector or ground loop.</li> <li>• Operator may be in a “soft shutdown.” Activate any keying device to determine if operator returns to normal operation.</li> <li>• If automatic close is desired, be sure SW 1, switch 4 is ON.</li> </ul>
Gate closes but will not open.	<ul style="list-style-type: none"> <li>• Operator may be in a “soft shutdown.” Check input LEDs. If any are ON, momentarily disconnect, then re-connect the wire going to the respective terminal. Operator should open.</li> <li>• Check to be sure that the operator is running in the proper direction. Turn power OFF, and then back ON. Activate a keying device. Operator should run in the open direction. If operator runs in the close direction, turn power OFF and change direction switch SW 1, switches 1 and/or 2. Go to above section if operator now opens but will not close.</li> <li>• Be sure that the respective LED on the control board lights when the keying device connected to the respective terminal is activated. If LED does not light, momentarily place a jumper wire from terminal 1 to the input terminal being checked. If LED lights and gate opens, problem is with the keying device. If LED does not light, replace control board.</li> <li>• Check motor as described above “Operator(s) will not run. Power LED is ON”.</li> </ul>
Gate starts to close, then reverses to open.	<ul style="list-style-type: none"> <li>• Disconnect the gate from the operator and check that the gate operates freely without any binding.</li> <li>• Check the loop detector LED’s and input LED’s. Any that flash ON will cause the gate to reverse.</li> <li>• Continue troubleshooting or replace the circuit board.</li> </ul>
Gate closes and opens continuously.	<ul style="list-style-type: none"> <li>• Check for any input or loop detector LED’s that are ON.</li> <li>• Check that the operator is running in the proper direction (see “gate closes but will not open”).</li> <li>• Check the SELF TEST jumper, see page 18.</li> </ul>
Alarm sounds for 5 minutes and then beeps once every 5 seconds. Operator will not run.	<ul style="list-style-type: none"> <li>• Operator is in a “hard shutdown” condition. Reset switch must be activated to return operator to normal operation, see Hard Shutdown Section 3.5, page 27.</li> </ul>
Operator has intermittent functionality problems that vary.	<ul style="list-style-type: none"> <li>• The 24 V POS terminal 250 mA power has been exceeded. Check total amp draw of connected device(s).</li> </ul>

## 4.4 Accessory Items

### UL 325 Monitored Entrapment Protection Devices available for the Solar Control Boxes.

#### Type B2 Contact Sensors (Reversing Edge)

- DoorKing 8080 Series Sensing Edges
- Miller Edge Sensing Edges - all models with a T2 (resistive) termination.
- Miller Edge wireless monitored transmitter/receiver kit model RB-G-K10
- ASO GMBH Sentir GF Series sensing edges

#### Type B1 Non-contact Sensors (Photo Cell)

- DoorKing Model 8080-057 Retro-Reflective Photocell
- Miller Edge Reflective-Guard Model RG
- Miller Edge Prime-Guard Model PG
- EMX Industries Model IRB-MON
- EMX Industries Model IRB-RET
- Omron Model E3K-R10K4
- Seco-Larm Model E-936-S45RRGQ
- Seco-Larm Model E-960-D90GQ

#### Monitored Expansion Kit

- Miller Edge Multi-Input Module Model MIM-62

### Accessory items available for the Solar Control Boxes.

**Low Current Draw External Loop Detector** - Detectors are solar friendly and mount into solar control box.  
Single channel detector - P/N 9402-050

**24 Volt 10 Watt Solar Panel.** P/N 2000-077. One (1) panel required for the 12 Volt - 18 Amp/Hr batteries.

**24 Volt 20 Watt Solar Panel.** P/N 2000-076. One (1) panel required for the 12 Volt - 35 Amp/Hr batteries.

**12 Volt 18 Amp Hour Battery.** P/N 1801-004. Two (2) required.

**12 Volt 35 Amp Hour Battery.** P/N 1801-005. Two (2) required.

**Coaxial Cable Antenna Kit** - External antenna with mounting bracket and 15 ft of coaxial cable. P/N 1514-073

**DKS 8040 Low Current Draw Radio Receiver and Antenna** - Operates at 318 MHz and **MUST** be used with either the DoorKing MicroPlus® **OR** MicroClik® transmitters. P/N 8040-080

**DKS Plug-In Low Current Draw Loop Detector** - Detector plug directly into **REVERSE LOOP PORT** on circuit board simplifying wiring.  
Single channel detector - P/N 9416-010

**Mounting Post Kit for Solar Control Box.** Attaches to concrete. P/N 100-045.

To attach post to concrete, DoorKing recommends four (4) 3/8" x 3" sleeve anchors (not supplied). Do Not mount post on asphalt.

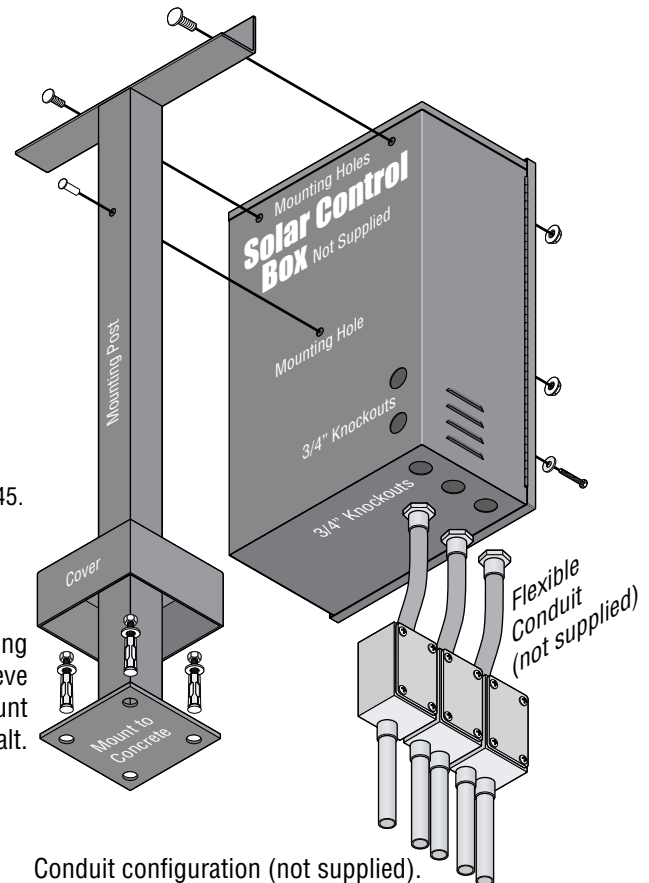

Conduit configuration (not supplied).





# IMPORTANT INFORMATION FOR OWNER



**A RELEASE TOOL (6004) or a KEY (6003, 6006 & 6400) has been supplied that will unlock the gate operator.**

**Note:** The **OWNER** of the gate operator is responsible for the **KEY** or **RELEASE TOOL** availability.

## Manually Operating the Gate (NO Power)

Choose your operator model and follow directions to unlock the operator and manually move the gate.

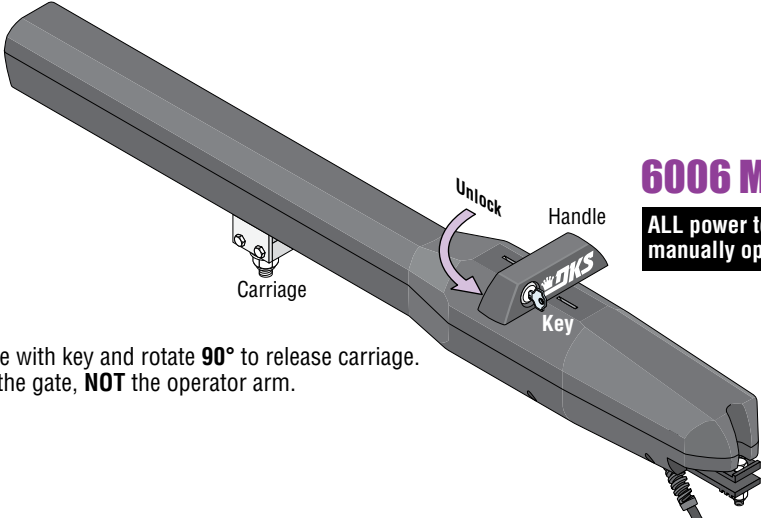

### 6006 Manual Release ONLY

**ALL power to the operator must be OFF BEFORE manually operating gate (See previous page).**

Unlock handle with key and rotate **90°** to release carriage. Push or pull the gate, **NOT** the operator arm.

### 6004 Manual Release ONLY

**ALL power to the operator must be OFF BEFORE manually operating gate (See previous page).**

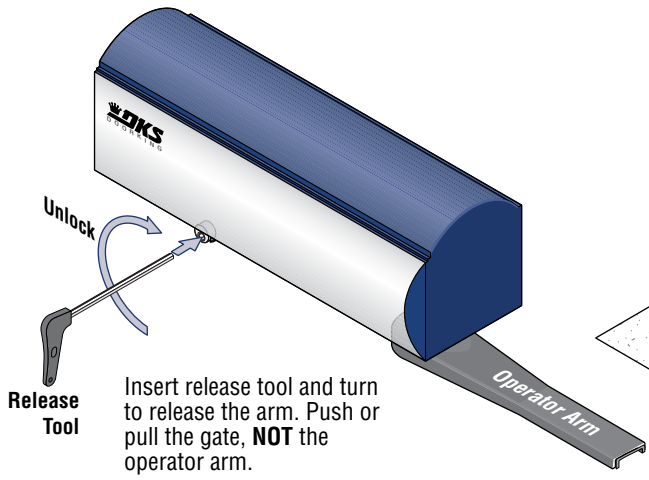

Insert release tool and turn to release the arm. Push or pull the gate, **NOT** the operator arm.

### 6400 Manual Release ONLY

**ALL power to the operator must be OFF BEFORE manually operating gate (See previous page).**

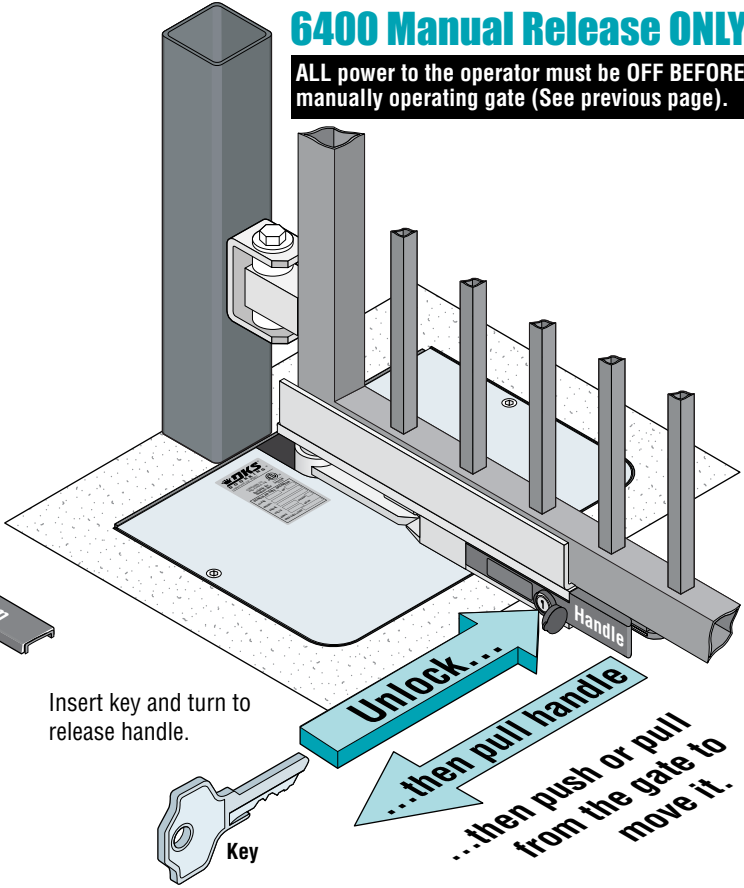

Insert key and turn to release handle.

**Unlock...**  
**...then pull handle**  
**...then push or pull from the gate to move it.**



# IMPORTANT INFORMATION FOR OWNER

## Gate Operator's Monthly Checkup

**Caution:** Make **SURE** gate area is clear **BEFORE** testing the gate operator!

**DO NOT** repair or adjust gate systems yourself. Contact a trained gate systems technician with any questions or to make any repairs or adjustments. If you feel uncomfortable performing any of these inspections or testing, a qualified service technician will perform the visual inspections and testing for you. You can find a trained service technician at DoorKing's "Dealer Locator" at [www.doorking.com](http://www.doorking.com)

### Visual Inspection

Visually inspect the rollers, fasteners, brackets and other gate hardware for proper alignment, proper tightness, and signs of damage, breakage, looseness, rust or wear. Moving parts should be lubricated and should not be squeaking. Visually inspect wiring for fraying or exposure. If a malfunction is found, contact a trained service technician to make adjustments or repairs.

### Test Built-In Reversing Sensor

Begin with the gate in the fully **OPEN** position. Stand just outside the path of the gate and close the gate (typically auto-timer will time-out and close gate automatically). As the gate is **closing**, firmly press a solid object against the end of the gate frame in the direction opposing the travel of the gate. The gate should **stop** within 2 sec. and **reverse** to the **OPEN** position. Another input command is needed before the gate will reset and close again. Repeat this test while **opening** the gate. Start from the fully **CLOSED** position. While **opening**, gate should **stop** and **reverse** to the **CLOSE** position. If gate does **NOT** respond like it should in **either** direction of gate travel, contact a trained service technician to make adjustments or repairs.

### Test Photo Sensors

If the gate has a photo sensing device protecting the path of a **closing gate**, perform the following test. Begin with the gate in the fully **OPEN** position. Stand just outside the path of the gate and close the gate (typically auto-timer will time-out and close gate automatically). Pass an object across the path of the closing photo sensing beam. The gate should **stop** within 2 sec. and **reverse** to the **OPEN** position. Typically the auto-timer times out and gate closes again. If the gate has a photo sensing device protecting the path of a **opening gate**, start from the fully **CLOSED** position. **OPEN** gate. Pass an object across the path of the opening photo sensing beam. The gate should **stop**, the gate will resume opening when the beam is clear. If gate does **NOT** respond like it should in **either** direction of gate travel, contact a trained service technician to make adjustments or repairs.

### Test Reversing Edges

If the gate has a reversing edge(s) protecting the path of a **closing gate**, perform the following test. Begin with the gate in the fully **OPEN** position. Stand just outside the path of the gate and close the gate. As the gate is closing, firmly press a solid object against the reversing edge in the direction opposing the travel of the gate. The gate should **stop** within 2 sec. and **reverse** to the **OPEN** position (typically auto-timer will time-out and close gate automatically). If the gate encounters **another** obstruction before it is closed, the gate will **stop** and reverse to the **OPEN** position **again**. A input command is needed before the gate will reset and close again, auto-timer will **NOT** close gate (Typically, press your remote button for input command). If the gate has a reversing edge(s) protecting the path of a **opening gate**, starting from the fully **CLOSED** position. Stand just outside the path of the gate and open the gate. **OPEN** gate. As the gate is opening, firmly press a solid object against the reversing edge in the direction opposing the travel of the gate. gate should **stop** and **reverse** to the **CLOSE** position. If gate does **NOT** respond like it should in **either** direction of gate travel, contact a trained service technician to make adjustments or repairs.

**Note:** This gate operator uses high levels of force to move the gate and most people underestimate the power of these systems and do not realize the potential hazards associated with this system if **NOT** maintained properly.

**Scheduled maintenance visits are offered by most qualified service technicians to MAINTAIN your gate operator system.**

# IMPORTANT INFORMATION FOR OWNER

## New Installation Checklist for Installer and Property Owner

**Instructions:** Check the space next to each item (“✓”) to indicate that it has been addressed by installer **AND** property owner. If it is not applicable, enter N/A. Please note that the checklist is intended to be a summary of many **important** automated vehicular gate aspects, **But may not inclusively identify all potential hazards of every specific gate system installation.**

**Each item listed and checked has been examined by the Installer and is CLEARLY understood by the Property Owner.**

Installer	Property Owner	Description
		<b>The operator is installed on a gate used for vehicles only.</b> Verify that separate pedestrian access is provided or available, and the access is such that pedestrians cannot come in contact with the moving vehicular access gate during its entire length of travel.
		<b>Gate/Hardware:</b> Insure that there is a means to prevent the gate from falling over in the event of a roller or hinge failure. Insure the gate has physical limit stops and that gravity will not initiate motion of the gate. Insure that all rollers are guarded or covered to eliminate the possibility of a finger being inserted between the roller and gate.
		<b>Slide Gate:</b> Insure that the maximum opening in the gate and in that portion of the adjacent fence that the gate covers when the gate is in the open position is such that a 2 ¼" sphere cannot pass through the openings up to 72 inches above the ground or to the top of the gate, whichever is less. If the gate and adjacent fence do not meet this requirement, wire mesh (or other means) must be added to meet this requirement before placing the gate system in operation.  Insure that any gaps between the slide gate and stationary posts/pilasters is less than 2 1/4" and that these areas are protected with an entrapment protection device.
		The gate operator system is in compliance with the <b>entrapment protection requirements of UL 325.</b> Identify all potential entrapment zones and ensure they are protected. Potential pinch areas have been guarded so as to be inaccessible OR have a contact (reverse edge) and/or non-contact (photocell) obstruction sensing devices installed. Verify that the system has in place external entrapment protection, independent from the inherent entrapment protection. Edge sensors or photocells are typical, other means are possible. For more information see your <b>specific</b> installation/owners manual for entrapment protection installation and locations.
		The installer has properly adjusted the <b>inherent entrapment protection feature</b> on the gate operator, and has tested the gate to make sure that the gate stops and reverses a short distance upon striking an immovable object.
		Check that placement of <b>user operational controls</b> are six (6) or more feet away from the gate. If any operational control is closer than six (6) feet to the gate, <b>DO NOT</b> place the automated vehicular gate into service.
		<b>Warning signs</b> are to be permanently installed in the area of the gate in such a manner that at least one warning sign is visible by persons located on each side of the gate, for both the secure and unsecure sides of the gate.
		The installer has instructed the property owner in the <b>proper use of the gate operator</b> and has reviewed the operational functions, obstruction-sensing devices, alarm, and reset as outlined in <b>your specific</b> installation/owners manual.
		The installer has instructed the property owner in the proper use of the operator's <b>manual release feature</b> as outlined in <b>your specific</b> installation/owners manual.
		The installer has <b>reviewed all safety instructions with the property owner</b> , including the need to never let children operate or play with gate controls, to keep the remote control away from children, and to always keep people and objects away from the gate.
		The installer has explained to the property owner that a <b>regular maintenance schedule</b> for both the gate and the gate operator is recommended, including regular testing of entrapment protection as outlined in the manufacturer's instructions.
		<b>The installer has left the installation/owners manual with the property owner for future reference.</b>

Wiring / Owner's  
Manual

# 4302 Solar Control Box for

6004, 6006 and 6400 gate operators

Use this manual for circuit board 4302-018 Revision A or higher.

4302-067-K-9-24

Entrapment Protection must be provided for the gate system where the risk of entrapment or obstruction exists. The operator will NOT run without one or more monitored type B1 or B2 entrapment protection devices in EACH entrapment area.

**UL 325 August 2018 Standard**



THIS PRODUCT IS TO BE INSTALLED AND SERVICED BY A TRAINED GATE/DOOR SYSTEMS TECHNICIAN ONLY.  
Visit [www.doorking.com/dealer-locator](http://www.doorking.com/dealer-locator) to find a professional installing and servicing dealer in your area.

[www.doorking.com](http://www.doorking.com)

DoorKing, Inc.  
120 S. Glasgow Avenue  
Inglewood, California 90301  
U.S.A.

Phone: 310-645-0023  
Fax: 310-641-1586