

Installation/Owner's Manual

9245

Heavy-Duty Vehicular Slide Gate Operator

Use this manual for circuit board 4404-018 Revision A or higher.

9245-065-T-9-24

Entrapment Protection must be provided for the gate system where the risk of entrapment or obstruction exists. The operator will NOT run without one or more monitored type B1 or B2 entrapment protection devices in EACH direction of gate travel.

UL 325 August 2018 Standard

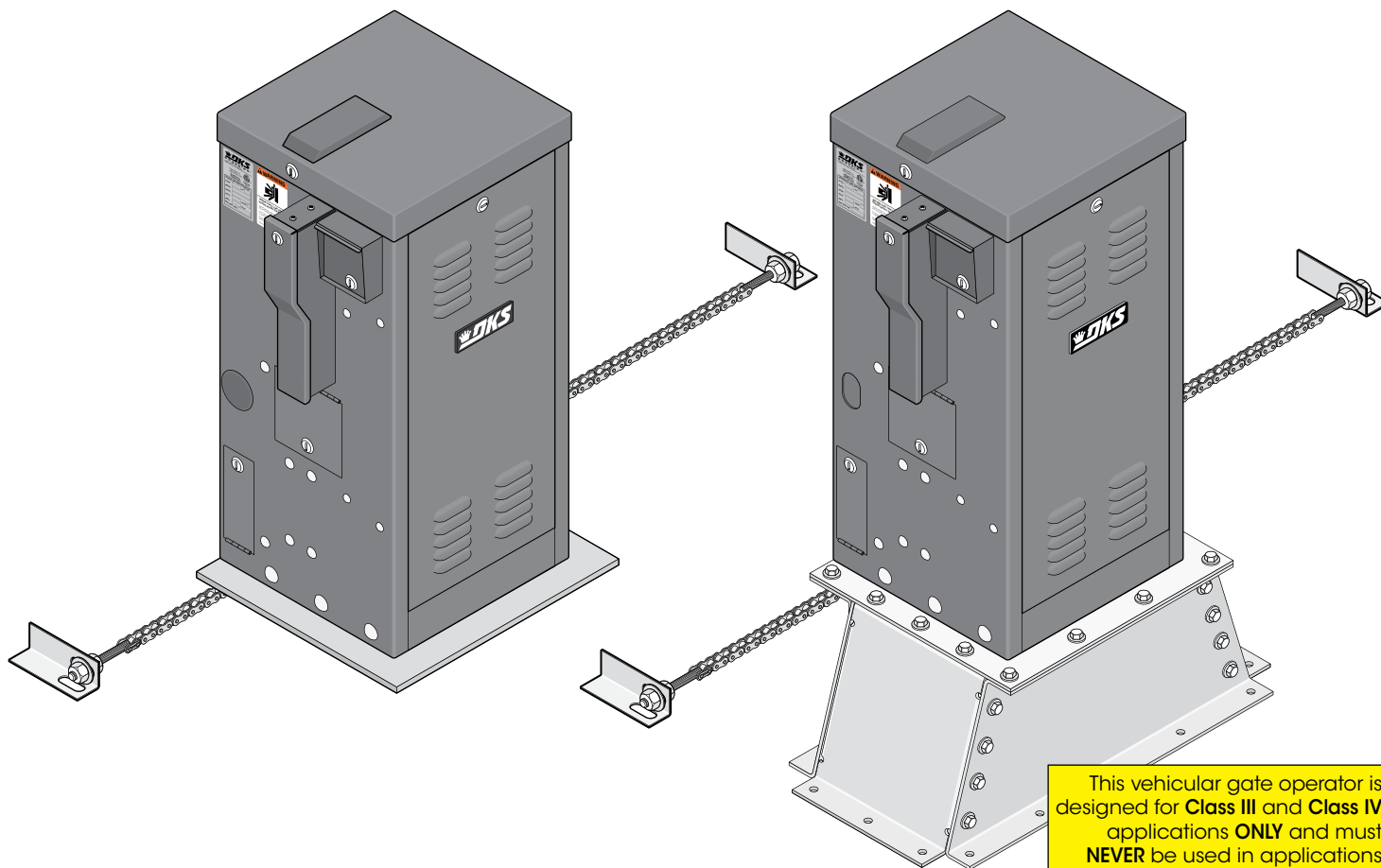

This vehicular gate operator is designed for **Class III** and **Class IV** applications **ONLY** and must **NEVER** be used in applications serving the general public.

THIS PRODUCT IS TO BE INSTALLED AND SERVICED BY A TRAINED GATE/DOOR SYSTEMS TECHNICIAN ONLY.
Visit www.doorking.com/dealer-locator to find a professional installing and servicing dealer in your area.

Owner of the gate operator is responsible for safe gate operation and must be aware of all safety requirements in this manual.

Date Installed: _____

Installer/Company Name: _____

Phone Number: _____

Circuit Board
Serial Number
and Revision Letter: _____

Leave Manual with Owner

Copyright 2024 DoorKing®, Inc. All rights reserved.



Listed to ANSI/CAN/UL 325



QUICK GUIDE: DIP-Switches

See page 19 for more information about DIP-switches.

The two DIP-switches located on the circuit board are used to program the operator to operate in various modes and to turn on or off various operating features. Whenever a switch setting is changed, power to the operator must be turned OFF and then turned back on for the new setting to take affect. Check and review ALL switch settings prior to applying power to the operator.

Left 3 Switches - SW 2

SW 2 is Upside-Down on Circuit Board.



Typical Settings

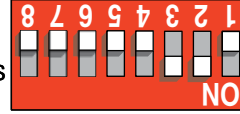

SW 1 - Right 8 Switches

SW 1 is Upside-Down on Circuit Board.

SW 1 - Right 8 Switches			
Switch	Function	Setting	Description
1	Changes the direction the operator will open/close the gate.		<p>Chain Configuration</p>
2	Auto-Close Timer	OFF	Auto-close timer is OFF. Manual input required to close gate.
		ON	Auto-close timer is ON. Adjustable from 1-23 seconds to close gate.
3	Exit Loop Port Output	Jumper Wire Needed OFF	The output wired to terminal #4 becomes the output from the loop detector installed in the EXIT loop port. Plug-in loop detector required for "OFF" function.
	Full Open Input	ON	Normal Setting. Terminal #4 is a normal full open input for a single gate operator.
4 and 5	Relay Activation and LED Indicator Light Activation	4-OFF 5-OFF	Relay activates and LED is ON when the gate is fully open.
		4-OFF 5-ON	Relay activates and LED is ON when the gate is not closed.
		4-ON 5-OFF	Relay activates and LED is ON when the gate is opening and open.
		4-ON 5-ON	Relay activates and LED is ON when the gate is opening and closing.
6	Warn Before Operate	OFF	Internal alarm will NOT sound.
		ON	Internal alarm will sound before gate starts and throughout gate's cycle.
7	Reverses Gate	OFF	Normal Setting. Input to terminal #6 and/or reverse loops will REVERSE gate during CLOSE cycle.
	Stops Gate	ON	Input to terminal #6 and/or reverse loops will STOP gate during CLOSE cycle.
8	Quick-Close Timer Override	OFF	Normal Setting. Timer will function normally.
		ON	Opening gate will stop and begin to close as soon as all reversing inputs (Reverse loops, photo sensors) are cleared regardless of the distance the gate has opened.

SW 2 - Left 3 Switches			
Switch	Function	Setting	Description
1	Self-Test	OFF	Normal Setting. Normal gate operation.
		ON	Self-test mode. Operator MUST be disconnected from gate to run self-test.
2	Gate Opens Uphill	OFF	Normal Setting. Normal gate operation.
		ON	MUST be ON if gate opens UPHILL.
3	Gate Opens Downhill	OFF	Normal Setting. Normal gate operation.
		ON	MUST be ON if gate opens DOWNHILL.

See page 28 for terminal wiring.

QUICK GUIDE: Terminal Descriptions

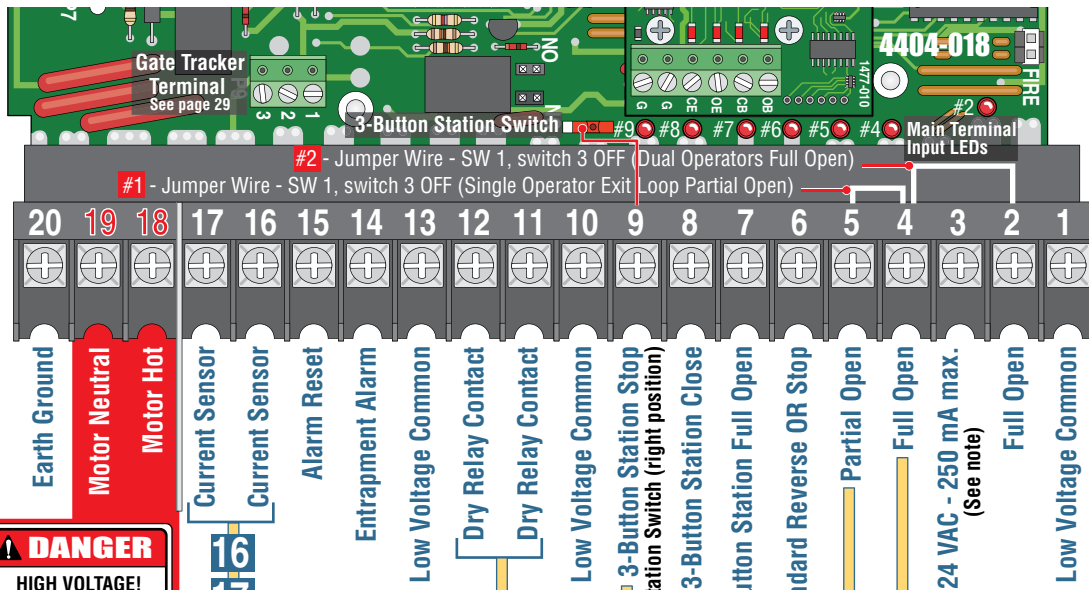

Auxiliary Common Terminal

Connect any low voltage common wire to these 2 terminals.

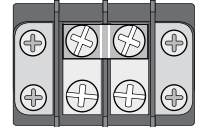

Low Voltage Common
Low Voltage Common



Used in conjunction with the circuit board inherent reversing sensors. See page 21 for further information.

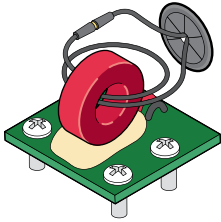

Main Terminal Input LEDs
Note: The LED that is above the main terminal wiring input will light when that terminal input gets activated.

Main Terminal #3 Note:
Exceeding 250 mA of power from this terminal may cause the circuit board transformer to overheat, causing intermittent problems.

- SW 1, switch 3 is **ON**, terminal #4 functions as a normal **FULL** open input. (Normal Setting). **Single operator use ONLY.**
- SW 1, switch 3 is **OFF**, input to terminal #4 becomes the output from a plug-in loop detector installed in the **EXIT loop port** of the circuit board. A jumper wire is needed to open and close the gate(s) for these applications:

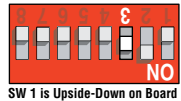

- #1** Terminal #4 jumpered to terminal #5 will **PARTIALLY** open an automatic exit loop using a **single channel** plug-in loop detector installed in the exit loop port when using a single gate operator.
- #2** Terminal #4 jumpered to terminal #2 will **FULLY** open bi-parting gates using a **dual channel** plug-in loop detector installed in the exit loop port when using dual gate operators.

Operation of relay is dependent on setting of SW 1, switches 4 and 5. See page 18 and 19 for DIP-switch function descriptions.

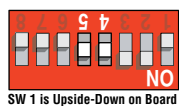

Relay contacts can be set for Normally Open (NO) or Normally Closed (NC) operation. Contact rating is 1 amp maximum at 24-volts DC.

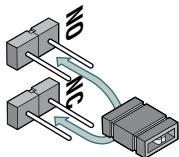

For long gate applications. An input device connected to terminal #5 will open the gate to the partial open setting. See page 20 for more information.

This input **ONLY** functions when gate is **fully opened** or in the **closing cycle**.

- When gate is closing: SW 1, **switch 7 is OFF**, an input to terminal #6 (N.O.) will **reverse** and open the gate. **Note:** If the auto-close timer is **ON**, when gate reaches the open position, timer will time out and close the gate.
- When gate is closing: SW 1, **switch 7 is ON**, an input to terminal #6 (N.O.) will **stop** the gate, then continue to close the gate when input is clear (Used to help prevent tailgating vehicles from unauthorized entry). See page 19 for more information.

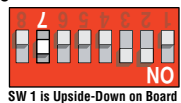

3-Button Control Station Switch
Switch in **RIGHT** position **ONLY** when using a **4-wire** 3-button control station with a normally closed **STOP** circuit.

IMPORTANT: Leave 3-button control station switch in **LEFT** position when **NOT** wiring a 3-button control station to control board otherwise operator will **NOT** function.

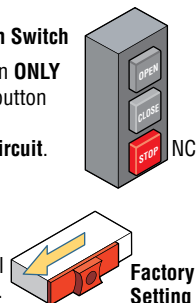

SPECIFICATIONS

Class of Operation	Series 9245 - UL 325 Class III, IV
Type of Gate	Vehicular Slide Gates Only
Operating Temperature	10° F to 140° F (-12° C to 62° C) "Optional" heater kits recommended for colder temperatures.
Inherent Entrapment Protection Device	Inherent Reverse Sensor System (Type A)
External Entrapment Protection Device Inputs (Monitored Inputs)	Connection inputs for Non-contact Sensor - Photo Sensor (Type B1) Connection input for Contact Sensor - Reversing Edge (Type B2)
Power Failure Operation	Fail-Safe

This vehicular gate operator is designed for Class III and Class IV applications only and must never be used in applications serving the general public.

Horse Power	Volt/Phase	Amps	Gearbox	Mech. Disc Brake	Gate Speed	Slow Down	Chain #	Max Gate Weight - lbs.	Max Gate Length - ft.	Gate Cycles	AC Module	Electronic Brake	Pedestal Stand Kit	Special Base Plate
3	208 / 1	12.8	10:1	Yes	2 ft/sec Adjustable	Yes	80	8000	100 Installed Level	Continuous	10 HP	Yes	With Standard Model Only	On Specialized Model Only
	230 / 1	12.6												

Entrapment Protection must be provided for the gate system where the risk of entrapment or obstruction exists. The operator will NOT run without one or more monitored type B1 or B2 external entrapment protection devices in EACH direction of gate travel (minimum of 2 external devices required).

Type of wiring to be used on ALL external devices:
A) Type CL2, CL2P, CL2R, or CL2X.
B) Other cable with equivalent or better electrical, mechanical, and flammability ratings.

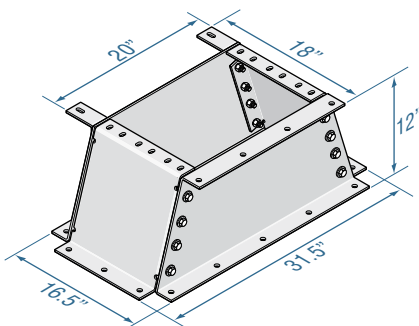

Heavy-Duty Pedestal Mounting Stand Kit

Included with Standard Model Only

Standard Model

Thinner base plate with mounting holes for the pedestal mounting stand.

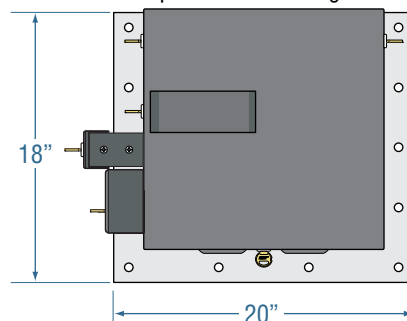

Specialized Base Plate Model

Thicker base plate without mounting holes.

Specialized base plate model operator's housing dimensions are the same as the standard model.

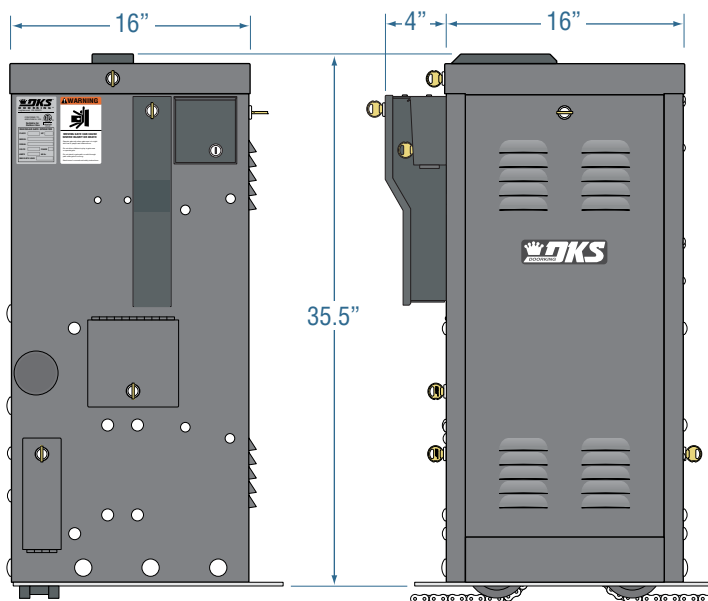
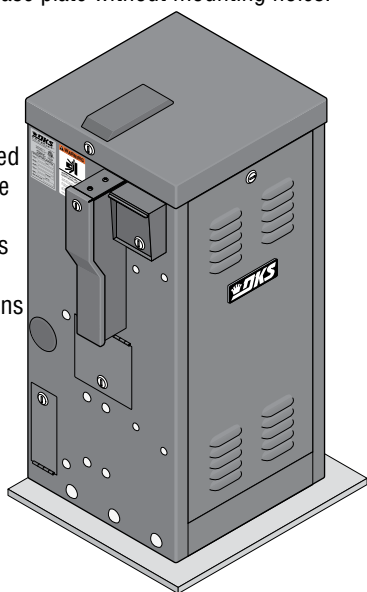

DoorKing, Inc. reserves the right to make changes in the products described in this manual without notice and without obligation of DoorKing, Inc. to notify any persons of any such revisions or changes. Additionally, DoorKing, Inc. makes no representations or warranties with respect to this manual. This manual is copyrighted, all rights reserved. No portion of this manual may be copied, reproduced, translated, or reduced to any electronic medium without prior written consent from DoorKing, Inc.

TABLE OF CONTENTS

QUICK GUIDES

Quick Guide: DIP-Switches	Quick Guide-1
Quick Guide: Terminal Descriptions	Quick Guide-2
Operator Specifications	Previous Page
Slide Gate Requirements	2
Safety Information for Slide Gate Operators	3
Gate Construction	4
Important Safety Instructions	4
Instructions regarding intended installation:	4
Important Installer/Owner Notices	5
UL325 Entrapment Protection	6
Glossary	7

SECTION 1 - INSTALLATION 8

1.1	Gate Hardware	8
1.2	Underground Conduit Requirements	8
1.3	Installation Options, Gate Types	9-10
1.4	Pedestal Mounting Stand Installation	11
1.5	“Specialized Base Plate” Installation	12
1.6	Chain Tray Kit Installation	13
1.7	Chain Installation	14
1.8	Installation of Warning Signs	15

SECTION 2 - AC POWER TO OPERATOR(S) 15

2.1	High Voltage Wire Runs	15
2.2	High Voltage Power Connection and Battery Power	16

SECTION 3 - ADJUSTMENTS 17

3.1	4404 Circuit Board Description and Adjustments	17
3.2	DIP-Switch SW 1 and SW 2 Settings	18-19
3.3	Limit Switches	20
3.4	Inherent Reverse Sensor Adjustment	21
3.5	Current Sensor Adjustment	21
3.6	AC Module Adjustment	22

SECTION 4 - ENTRAPMENT AND SAFETY PROTECTION 23

4.1	UL 325 Terminal Description	23
4.2	Entrapment Protection Device Locations	24-25
4.3	Loop Detector Wiring	26

SECTION 5 - MAIN TERMINAL WIRING 27

5.1	Main Terminal Description	27
5.2	Control Wiring for Single/Primary Operator	28
5.3	Auxiliary Device Wiring	29

SECTION 6 - OPERATING INSTRUCTIONS 30

6.1	AC Power and Reset Button	30
6.2	Shutdown Conditions	31
6.3	Manual Gate Operation	32

SECTION 7 - MAINTENANCE AND TROUBLESHOOTING 33

7.1	Maintenance	33
7.2	Built-In Diagnostic Tests	34
7.3	Troubleshooting	34-35
7.4	Accessory Items	36
	9245 Wiring Schematics	37

SECTION 8 - OWNER OF THE GATE OPERATOR 38

8.1	Alarm Sounding and Gate WILL NOT Operate	38
8.2	Manual Gate Operation	39
8.3	Gate Operators Monthly Checkup	40
	Printable Safety Page	41

Slide Gate Requirements

This operator is intended for installation only on gates used for vehicles. Pedestrians must be supplied with a separate access opening. For pedestrian access in the vicinity of an automated vehicular gate, separate pedestrian access shall be provided or available. The pedestrian access shall be in a location such that a pedestrian shall not come in contact with a moving vehicular gate access gate during the entire path of travel of the vehicular gate. A pedestrian gate shall not be incorporated into an automated vehicular gate panel.

Adjacent fence that covers open gate position.

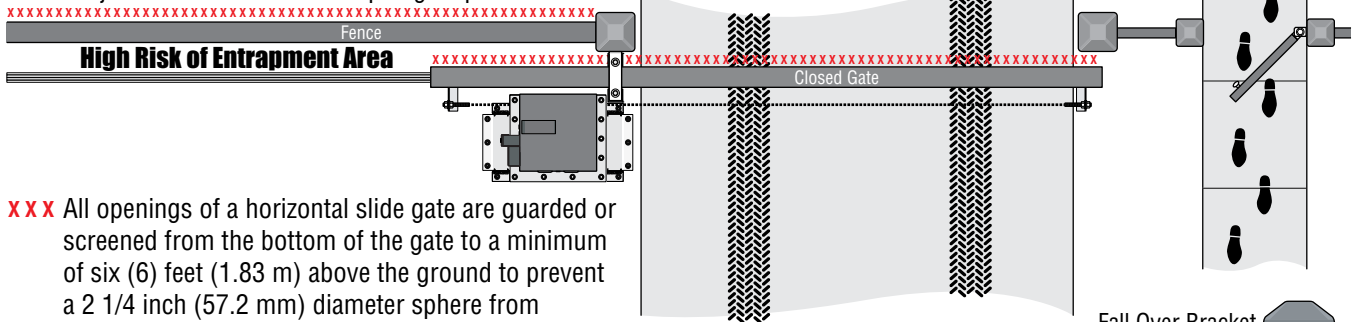

XXX All openings of a horizontal slide gate are guarded or screened from the bottom of the gate to a minimum of six (6) feet (1.83 m) above the ground to prevent a 2 1/4 inch (57.2 mm) diameter sphere from passing through the openings anywhere in the gate and in that portion of the adjacent fence that the gate covers in the open position.

Gates shall be designed, constructed and installed to not fall over more than 45 degrees from the vertical plane, when a gate is detached from the supporting hardware.

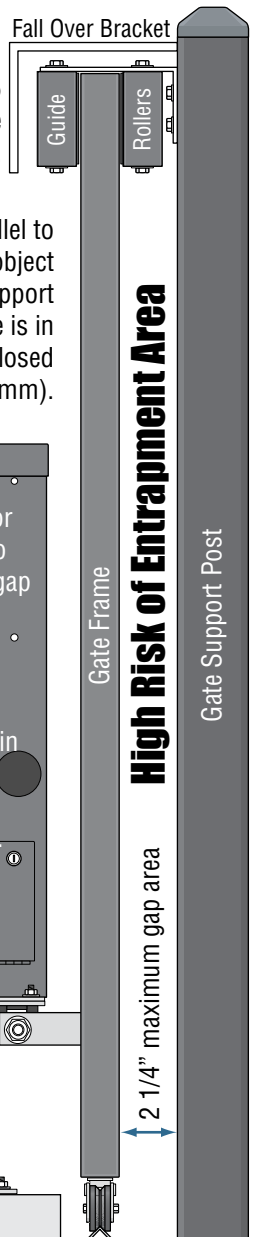

A gap, measured in the horizontal plane parallel to the roadway, between a fixed stationary object nearest the roadway (such as a gate support post) and the gate frame when the gate is in either the fully open position or the fully closed position, shall not exceed 2 1/4 inch (57.2 mm).

Screened Wire Mesh Less than 2 1/4"

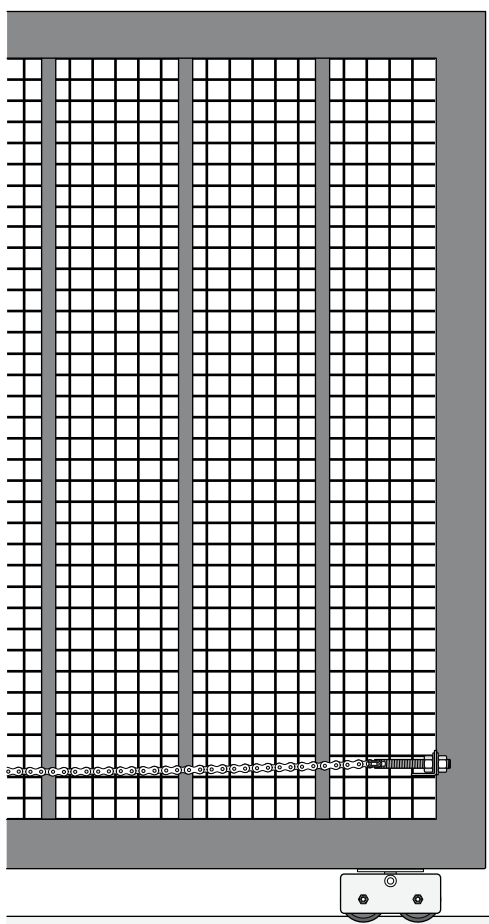

Screened wire mesh is **REQUIRED** on the **ENTIRE** gate **AND** on that portion of the adjacent fence that the gate covers in the open position. (See above).

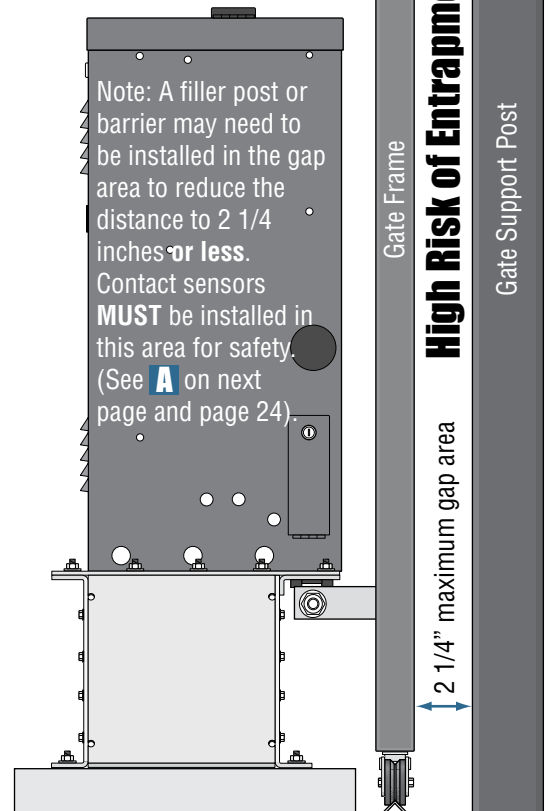

Safety Information for Slide Gate Operators

Illustration not to scale.

Entrapment protection devices are required to reduce the risk of injury. Install sensors where the risk of entrapment or obstruction exists while gate is moving. **Individual requirements will vary.** See pages 23-26 for more information on typical layout locations and setup.

Non-Contact Sensors (Photo Sensors)

- 1** Helps minimize the potential of entrapment during the closing cycle of the gate. Minimizes the potential of the gate closing on vehicular or other traffic that loops cannot sense. It can be installed on the secure **OR** non-secure side of gate.
- 2** Helps minimize the potential of entrapment during the back travel of the gate (opening cycle). See previous page for gate gap information.

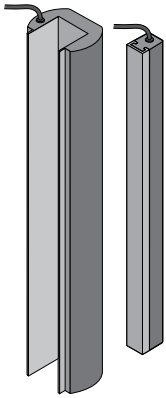

Contact Sensor (Reversing Edges)

- A** Installed on the fence to help minimize the potential of entrapment between the gate and fence during the opening cycle of the gate. A filler post or barrier **MAY** need to be installed between fence and gate.
- B** Helps minimize the potential of entrapment during the back travel of the gate (opening cycle).
- C** Helps minimize the potential of entrapment during the closing cycle of the gate. Minimizes the potential of the gate closing on vehicular or other traffic that loops cannot sense.

Guide Rollers

See previous page for more information.

Physical Stops

Positive stops shall be required to limit travel to the designed fully open and fully closed positions. These stops shall be installed either at the top of the gate, or at the bottom of the gate where such stops shall horizontally or vertically project no more than is required to perform their intended function.

Screened Wire Mesh

May be necessary on part of fence **AND** entire gate. See previous page for more information.

Warning Sign

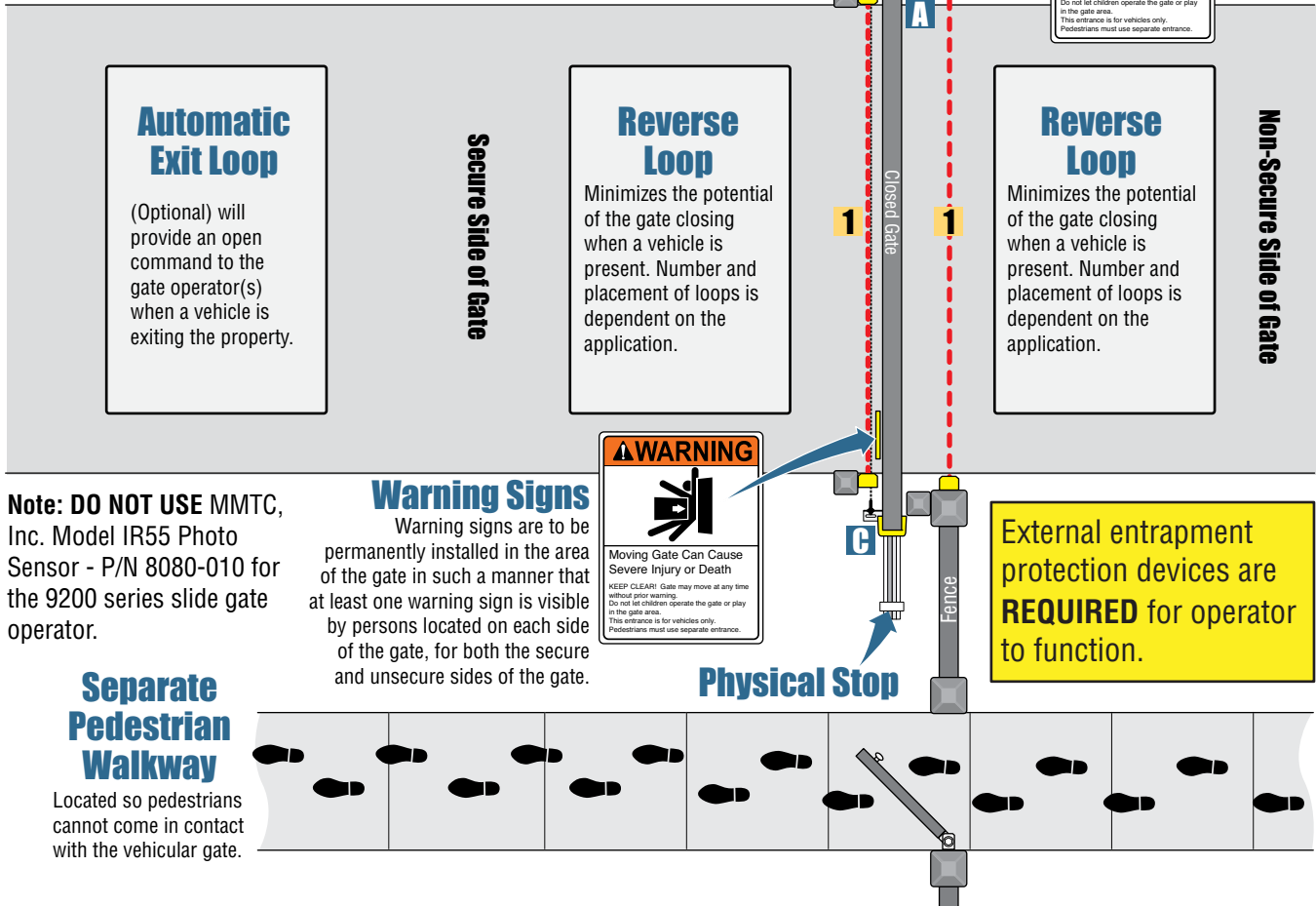

Automatic Exit Loop

(Optional) will provide an open command to the gate operator(s) when a vehicle is exiting the property.

Secure Side of Gate

Reverse Loop

Minimizes the potential of the gate closing when a vehicle is present. Number and placement of loops is dependent on the application.

Reverse Loop

Minimizes the potential of the gate closing when a vehicle is present. Number and placement of loops is dependent on the application.

Non-Secure Side of Gate

Note: DO NOT USE MMTc, Inc. Model IR55 Photo Sensor - P/N 8080-010 for the 9200 series slide gate operator.

Warning Signs

Warning signs are to be permanently installed in the area of the gate in such a manner that at least one warning sign is visible by persons located on each side of the gate, for both the secure and unsecure sides of the gate.



Physical Stop

External entrapment protection devices are **REQUIRED** for operator to function.

Separate Pedestrian Walkway

Located so pedestrians cannot come in contact with the vehicular gate.

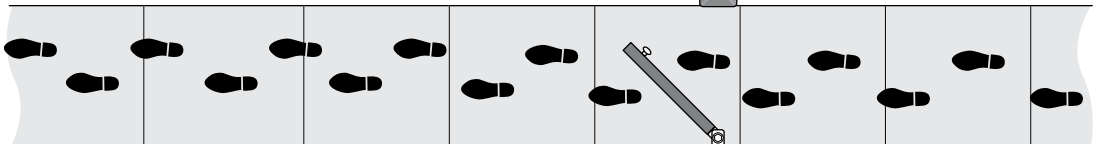

ASTM F2200 Standard for Gate Construction

Vehicular gates should be constructed and installed in accordance with ASTM F2200; Standard Specification for Automated Vehicular Gate Construction. For a copy of this standard, contact ASTM directly at 610-832-9585; service@astm.org; or www.astm.org.

Important Safety Instructions

WARNING - To reduce the risk of severe injury or death:

1. READ AND FOLLOW ALL INSTRUCTIONS.
2. Never let children operate or play with gate controls. Keep the remote control away from children.
3. Always keep people and objects away from gate. **NO ONE SHOULD CROSS THE PATH OF THE MOVING GATE.**
4. Test the operator monthly. The gate **MUST** reverse on contact with a rigid object or stop or reverse when an object activates the non-contact sensors. After adjusting the force or the limit of travel, retest the gate operator. Failure to adjust and retest the gate operator properly can increase the risk of severe injury or death.
5. Use the manual release only when the gate is not moving.
6. **KEEP GATES PROPERLY MAINTAINED.** Read the owner's manual. Have a qualified service person make repairs to gate hardware.
7. The operator is intended for installation on gates used for vehicles. Pedestrians must be supplied with a separate access opening. The pedestrian access opening shall be designed to promote pedestrian usage. Locate the gate such that persons will not come in contact with the vehicular gate during the entire path of travel of the vehicular gate.
8. **SAVE THESE INSTRUCTIONS!**

Instructions regarding intended installation:

- Install the gate operator only if:
 1. The operator is appropriate for the construction of the gate and the usage class of the gate.
 2. All openings of a horizontal slide gate are guarded or screened from the bottom of the gate to a minimum of 6 feet (1.83 m) above the ground to prevent a 2 ¼ inch (57.2 mm) diameter sphere from passing through the openings anywhere in the gate, and in that portion of the adjacent fence that the gate covers in the open position.
 3. All exposed pinch points are eliminated or guarded.
 4. Guarding is supplied for exposed rollers.
- The operator is intended for installation only on gates used for vehicles. Pedestrians must be supplied with a separate access opening. The pedestrian access opening shall be designed to promote pedestrian usage. Locate the gate such that persons will not come in contact with the vehicular gate during the entire path of travel of the vehicular gate.
- The gate must be installed in a location so that enough clearance is supplied between the gate and adjacent structures when opening and closing to reduce the risk of entrapment. Swinging gates should not open into public access areas.
- The gate must be properly installed and work freely in both directions prior to the installation of the gate operator. Do not over-tighten the operator clutch, pressure relief valve or reduce reversing sensitivity to compensate for a damaged gate.
- For gate operators utilizing Type D protection:
 1. The gate operator controls must be placed so that the user has full view of the gate area when the gate is moving.
 2. A warning placard shall be placed adjacent to the controls.
 3. An automatic closing device (such as a timer, loop sensor, or similar device) shall not be employed.
 4. No other activation device shall be connected.
- Controls intended for user activation must be located at least six feet (6') away from any moving part of the gate and where the user is prevented from reaching over, under, around or through the gate to operate the controls. Outdoor or easily accessible controls should have a security feature to prevent unauthorized use.
- The Stop and/or Reset button must be located in the line-of-sight of the gate. Activation of the reset control shall not cause the operator to start.
- Warning signs are to be permanently installed in the area of the gate in such a manner that at least one warning sign is visible by persons located on each side of the gate, for both the secure and unsecure sides of the gate.
- For gate operators utilizing a non-contact sensor:
 1. See the instructions on the placement of non-contact sensors for each type of application.
 2. Care shall be exercised to reduce the risk of nuisance tripping, such as when a vehicle trips the sensor while the gate is still moving in the opening direction.
 3. One or more non-contact sensors shall be located where the risk of entrapment or obstruction exist, such as the perimeter reachable by a moving gate or barrier.
- For gate operators utilizing contact sensors:
 1. One or more contact sensors shall be located where the risk of entrapment or obstruction exist, such as at the leading edge, trailing edge, and post mounted both inside and outside of a vehicular horizontal slide gate.
 2. One or more contact sensors shall be located at the bottom edge of a vehicular vertical lift gate.
 3. One or more contact sensors shall be located at the pinch point of a vehicular vertical pivot gate.
 4. A hardwired contact sensor shall be located and its wiring arranged so that the communication between the sensor and the gate operator is not subjected to mechanical damage.
 5. A wireless contact sensor such as one that transmits radio frequency (RF) signals to the gate operator for entrapment protection functions shall be located where the transmission of the signals are not obstructed or impeded by building structures, natural landscaping or similar obstructions. A wireless contact sensor shall function under the intended end-use conditions.
 6. One or more contact sensors shall be located at the bottom edge of a vertical barrier (arm).
- Be sure you have instructed the owner of the gate operator about safe and proper operation and testing of the gate operator.

Important Installer/Owner Notices

Vehicular gate operator products provide convenience and security. However, gate operators must use high levels of force to move gates and most people underestimate the power of these systems and do not realize the potential hazards associated with an incorrectly designed or installed system. Be sure your installer has addressed hazards which may include:

- Unprotected pinch points
- Unprotected entrapment areas
- Reach through hazards (Absence of screen wire mesh)
- Absence of entrapment protection devices
- Improperly located access controls (see below)
- Absence of vehicle protection devices
- Absence of separate controlled pedestrian access

In addition to these potential hazards, automated vehicular gate systems must be installed in accordance with the UL 325 Safety Standard and the ASTM F2200 Construction Standard. Most people are unaware of, or are not familiar with, these standards. If an automated vehicular gate system is not properly designed, installed, used and maintained, severe injuries or death can result. Be sure that the installer has instructed you on the proper operation of the gate and gate operator system.

Be sure that the installer has trained gate operator owner on proper and safe operation of this gate operating system and about the basic functions of the required reversing systems associated with your gate operating system and how to test them (see section 8). These include reversing loops, inherent reversing system, electric edges, photoelectric cells, or other external devices. Owner of the gate operator is responsible for training all personnel using the gate operator system on proper safe use of the system.

- This Owner's Manual is your property. Keep it in a safe place for future reference.
- Be sure that all access control devices are installed a minimum distance of 6 feet away from the gate and gate operator, or in such a way that a person cannot touch the gate or gate operator while using the device. If access control devices are installed in violation of these restrictions, immediately remove the gate operator from service and contact your installing dealer.

Controls intended for user activation must be located at least six feet (6') away from any moving part of the gate and where the user is prevented from reaching over, under, around or through the gate to operate the controls. Outdoor or easily accessible controls should have a security feature to prevent unauthorized use.



- Loops and loop detectors, photo-cells or other equivalent devices must be installed to prevent the gate from closing on vehicular traffic.
- The speed limit for vehicular traffic through the gate area is 5 MPH. Install speed bumps and signs to keep vehicular traffic from speeding through the gate area. Failure to adhere to posted speed limits can result in damage to the gate, gate operator, and to the vehicle.
- Be sure that all persons who will use the gate system are familiar with the proper use of the gate and gate operator and are familiar with the possible hazards associated with the gate system.
- Warning signs are to be permanently installed in the area of the gate in such a manner that at least one warning sign is visible by persons located on each side of the gate, for both the secure and unsecure sides of the gate.
- It is your responsibility to periodically check all entrapment protection devices. If any of these devices are observed to function improperly, remove the operator from service immediately and contact your installing or servicing dealer.
- Follow the recommended maintenance schedule.
- Do not allow children to play in the area of the operator or to play with any gate-operating device.
- To remove the gate operator from service, operate the gate to the full open position and then shut off power to the operator at the service panel.

UL325 Entrapment Protection

UL 325 Classifications



Class I - Residential Vehicular Gate Operator

A vehicular gate operator (or system) intended for use in garages or parking areas associated with a residence of one-to four single families.



Class III - Industrial/Limited Access Vehicular Gate Operator

A vehicular gate operator (or system) intended for use in an industrial location or building such as a factory or loading dock area or other locations not accessible by or intended to service the general public.

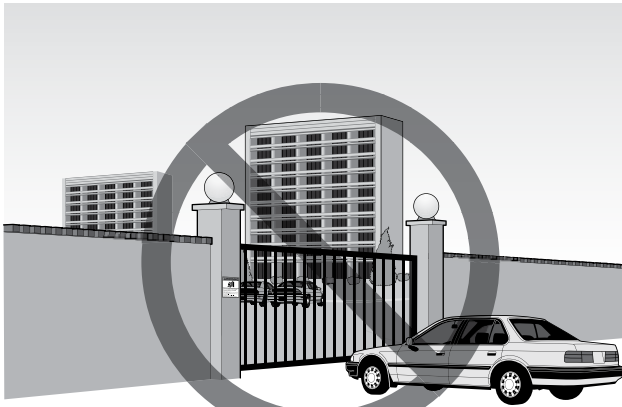

Class II - Commercial/General Access Vehicular Gate Operator

A vehicular gate operator (or system) intended for use in a commercial location or building such as a multi-family housing unit (five or more single family units), hotel, garages, retail store, or other buildings accessible by or servicing the general public.



Class IV - Restricted Access Vehicular Gate Operator

A vehicular gate operator (or system) intended for use in a guarded industrial location or building such as an airport security area or other restricted access locations not servicing the general public, in which unauthorized access is prevented via supervision by security personnel.

Gate Operator Category

	Horizontal Slide, Vertical Lift, Vertical Pivot, Horizontal Bifold	Swing, Vertical Barrier (Arm)
Entrapment Protection Types	A, B1*, B2* or D	A, B1*, B2*, C or D

Type A - Inherent entrapment protection system.

Type B1 - Non-contact sensor (photoelectric sensor or the equivalent).

Type B2 - Contact sensor (edge device or equivalent).

Type C - Inherent force limiting, inherent adjustable clutch or inherent pressure relief device.

Type D - Actuating device requiring constant pressure to maintain opening or closing motion of the gate.

* B1 and B2 means of entrapment protection must be MONITORED.

Vertical Barrier Note: Barrier gate operators (arm) that is not intended to move toward a rigid object closer than 16 inches (406 mm) are not required to be provided with a means of entrapment protection.

Glossary

GATE - A moving barrier such as a swinging, sliding, raising, lowering, folding, pivoting, or the like, barrier, that is a stand-alone passage barrier or is that portion of a wall or fence system that controls entrance and/or egress by persons or vehicles and completes the perimeter of a defined area.

RESIDENTIAL VEHICULAR GATE OPERATOR – CLASS I - A vehicular gate operator (or system) intended for use in a home of one-to four single family dwelling, or garage or parking area associated therewith.

COMMERCIAL / GENERAL ACCESS VEHICULAR GATE OPERATOR - CLASS II - A vehicular gate operator (or system) intended for use in a commercial location or building such as a multi-family housing unit (five or more single family units), hotels, garages, retail store, or other building servicing the general public.

INDUSTRIAL / LIMITED ACCESS VEHICULAR GATE OPERATOR - CLASS III - A vehicular gate operator (or system) intended for use in an industrial location or building such as a factory or loading dock area or other locations not intended to service the general public.

RESTRICTED ACCESS VEHICULAR GATE OPERATOR - CLASS IV - A vehicular gate operator (or system) intended for use in a guarded industrial location or building such as an airport security area or other restricted access locations not servicing the general public, in which unauthorized access is prevented via supervision by security personnel.

VEHICULAR BARRIER (ARM) OPERATOR (OR SYSTEM) - An operator (or system) that controls a cantilever type device (or system), consisting of a mechanical arm or barrier that moves in a vertical arc, intended for vehicular traffic flow at entrances or exits to areas such as parking garages, lots or toll areas.

VEHICULAR HORIZONTAL SLIDE-GATE OPERATOR (OR SYSTEM) - A vehicular gate operator (or system) that controls a gate which slides in a horizontal direction that is intended for use for vehicular entrance and exit to a drive, parking lot, or the like.

VEHICULAR SWING-GATE OPERATOR (OR SYSTEM) - A vehicular gate operator (or system) that controls a gate which moves in an arc in a horizontal plane that is intended for use for vehicular entrance and exit to a drive, parking lot, or the like.

SYSTEM - In the context of these requirements, a system refers to a group of interacting devices intended to perform a common function.

WIRED CONTROL - A control implemented in a form of fixed physical interconnections between the control, the associated devices, and an operator to perform predetermined functions in response to input signals.

WIRELESS CONTROL - A control implemented in means other than fixed physical interconnections (such as radio waves or infrared beams) between the control, the associated devices, and an operator to perform predetermined functions in response to input signals.

INHERENT ENTRAPMENT PROTECTION SYSTEM - A system, examples being a motor current or speed sensing system, which provides protection against entrapment upon sensing an object and is incorporated as a permanent and integral part of the operator.

EXTERNAL ENTRAPMENT PROTECTION DEVICE - A device, examples being an edge sensor, a photoelectric sensor, or similar entrapment protection device, which provides protection against entrapment when activated and is not incorporated as a permanent part of an operator.

ENTRAPMENT - The condition when a person is caught or held in a position that increases the risk of injury.

SECTION 1 - INSTALLATION

Prior to beginning the installation of the slide gate operator, we suggest that you become familiar with the instructions, illustrations, and wiring guide-lines in this manual. This will help insure that your installation is performed in an efficient and professional manner compliant with UL 325 safety and ASTM F2200 construction standards.

The proper installation of the vehicular slide gate operator is an extremely important and integral part of the overall access control system. Check all local building ordinances and building codes prior to installing this operator. Be sure your installation is in compliance with local codes.

1.1 Gate Hardware

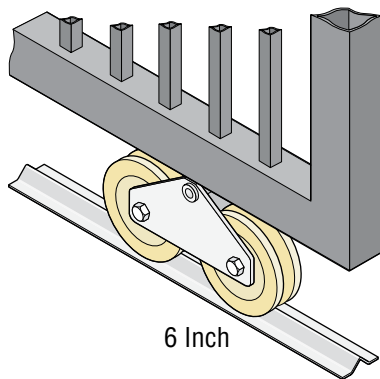

6 Inch

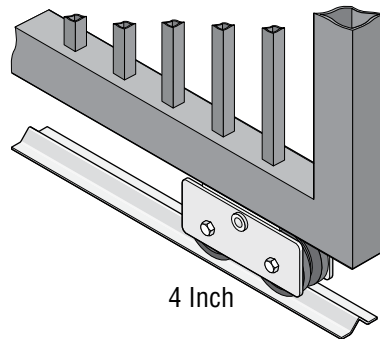

4 Inch

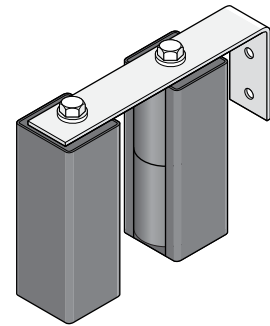

Guide Rollers with Protective Covers
Helps to minimize a pinch point on the gate.

1.2 Underground Conduit Requirements

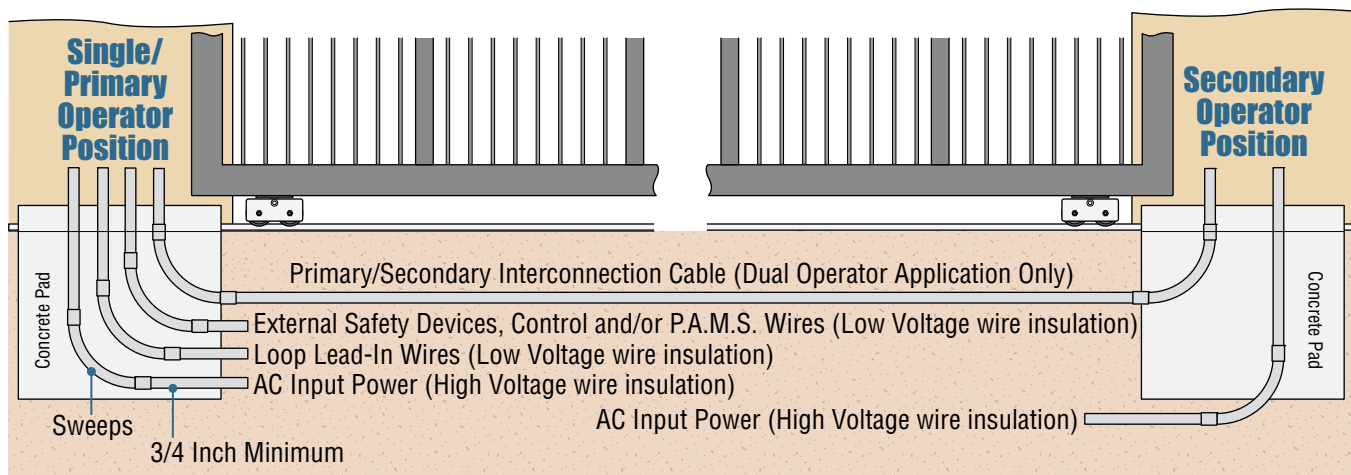

- The conduit requirements are for a typical slide gate operator installation (the secondary operator is shown for those applications where a secondary operator may be used). **The conduit requirements for your application may vary from this depending on your specific needs.**
- Use only sweeps for conduit bends. Do not use 90° elbows as this will make wire pulls very difficult and can cause damage to wire insulation. DoorKing recommends using 3/4-inch conduit.
- **External Entrapment Protection is REQUIRED** (photo sensors and/or reversing edges).
- Be sure that all conduits are installed in accordance with local codes.
- **Never** run low voltage rated wire insulation in the same conduit as high voltage rated wire insulation.

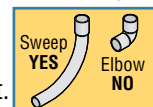

1.3 Installation Options

A chain tray is recommended for gates that are longer than 20 feet in length. The chain tray helps support the weight of the chain and reduce the chain stretching that occurs over time. DoorKing offers a chain tray kit that will fit any length gate (P/N 2601-270 10 ft. connecting sections). See page 13 for details.

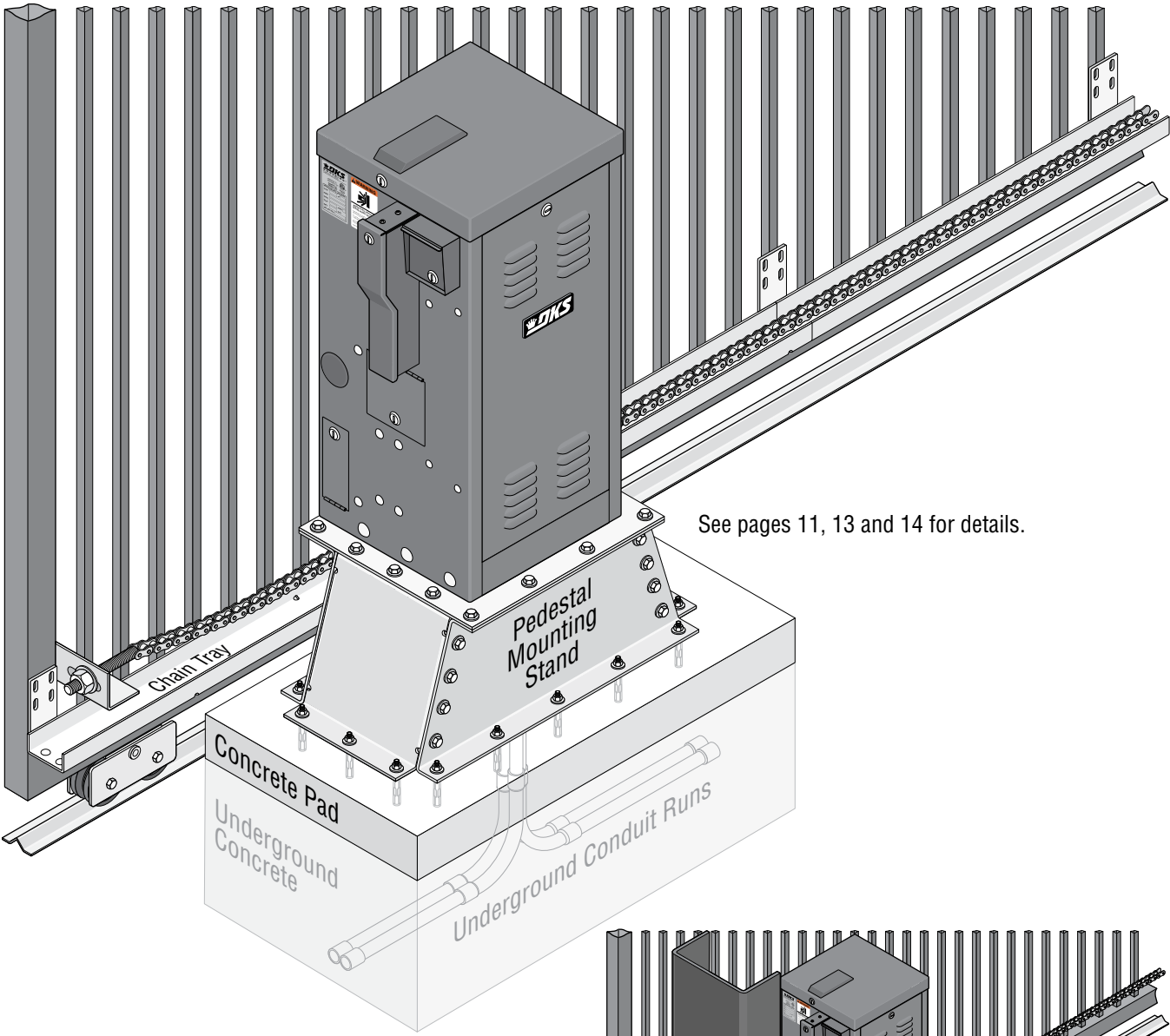

See pages 11, 13 and 14 for details.

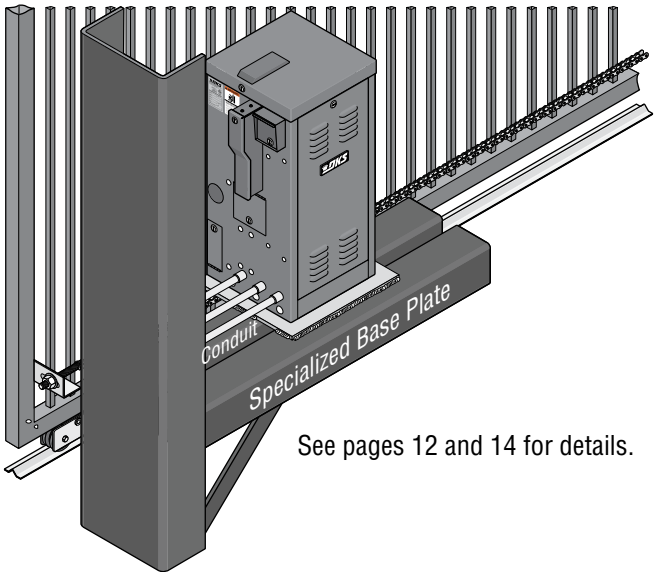

See pages 12 and 14 for details.

1.3 Gate Types

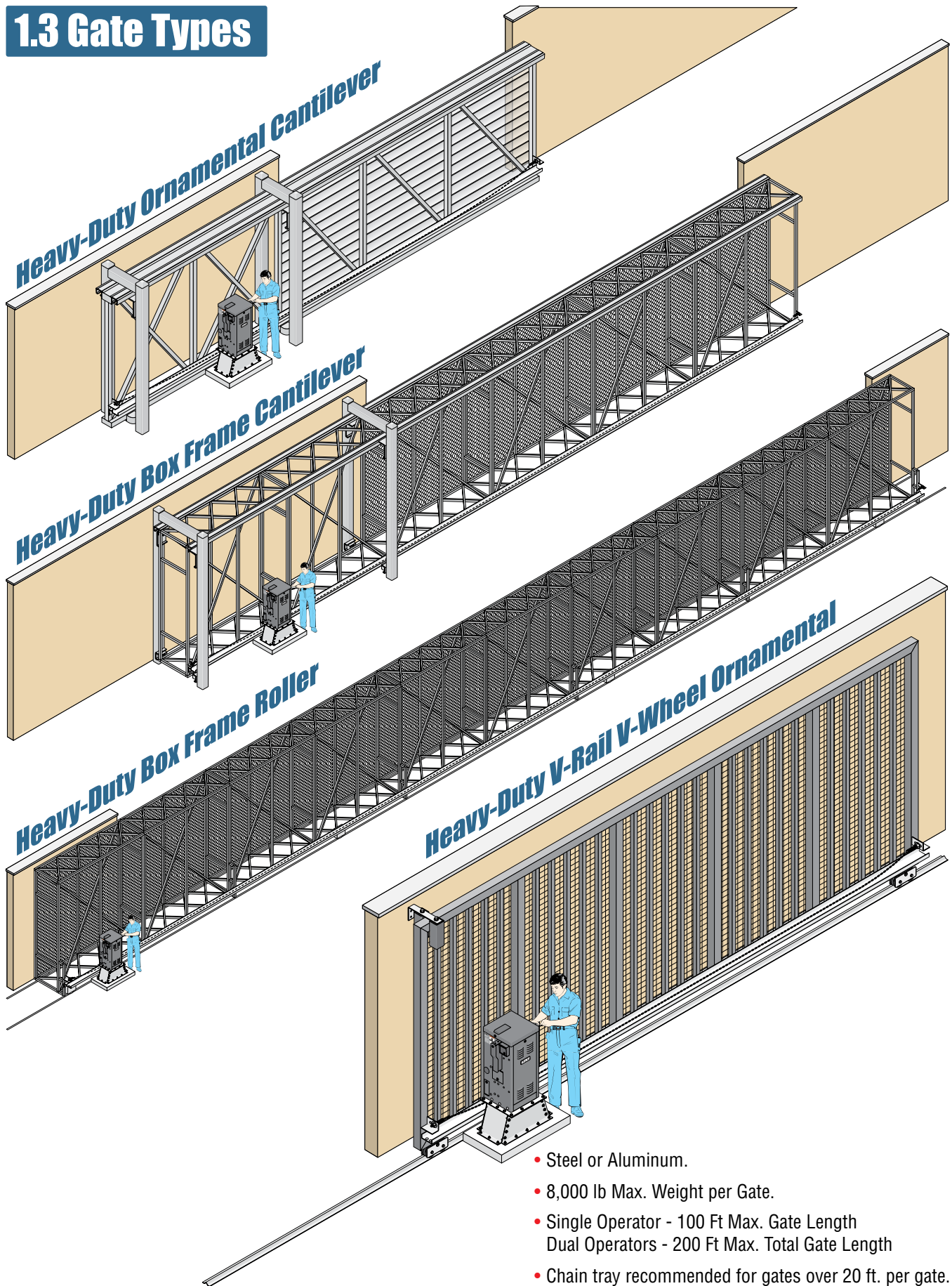

- Steel or Aluminum.
- 8,000 lb Max. Weight per Gate.
- Single Operator - 100 Ft Max. Gate Length
Dual Operators - 200 Ft Max. Total Gate Length
- Chain tray recommended for gates over 20 ft. per gate.

1.4 Pedestal Mounting Stand Installation

The operator is heavy. Two persons are required when handling the operator during installation.

Caution: DO NOT lay the operator on it's side or oil will leak out of the gear reducer.

1. Assemble and install the pedestal mounting stand kit on the concrete pad, then mount the operator to it. Follow the instructions that comes with the pedestal mounting stand kit for assembly of the stand.
2. Install operator on the pedestal mounting stand and install on the concrete pad (See below).
3. Install chain tray kit on the gate (See page 13 for details).

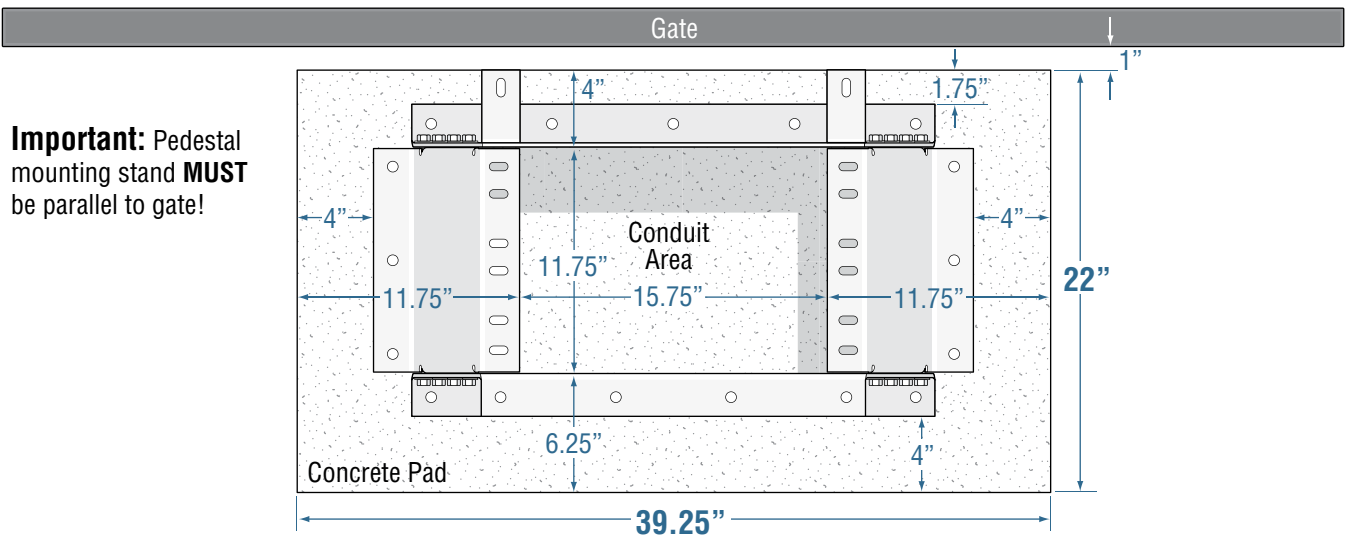

Important: Pedestal mounting stand **MUST** be parallel to gate!

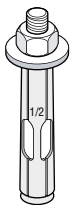

To attach pedestal stand to concrete pad, DoorKing recommends sixteen (16) 1/2" x 3" sleeve anchors (not supplied).

DO NOT set anchor bolts in wet concrete. Sleeve anchors should be used after concrete has cured for greater flexibility in positioning the pedestal stand on the pad.

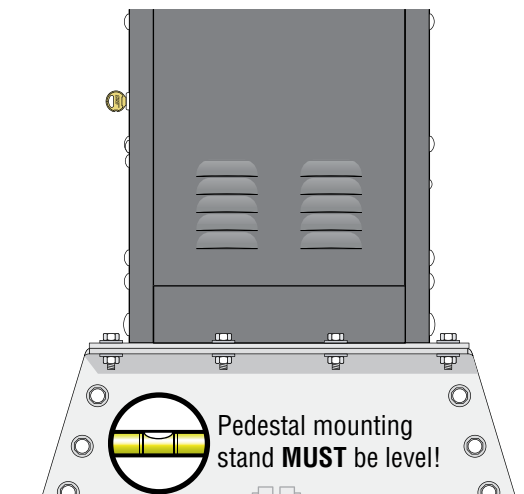

Conduit suggestions:

- High voltage conduit
- Low voltage access control device conduit
- Automatic exit loop conduit
- Reverse loop conduit

Pad depth is determined by soil conditions and local building codes. Minimum depth is 18 inches.

Reinforced concrete recommended.

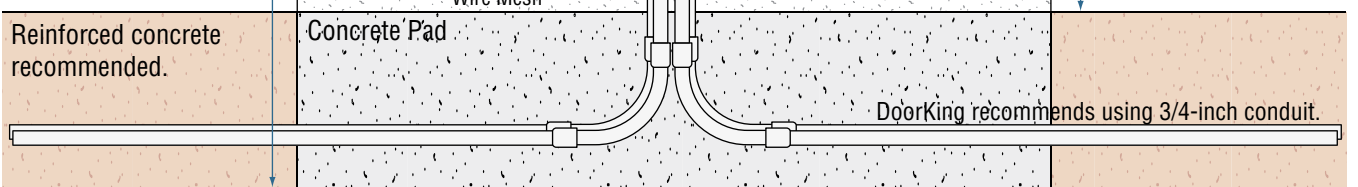

1.5 “Specialized Base Plate” Installation

The operator is heavy. Two persons are required when handling the operator during installation.

Caution: DO NOT lay the operator on it's side or oil will leak out of the gear reducer.

1. Install the operator on an existing metal stand (See below).
2. Install chain tray kit on the gate (See next page for details).

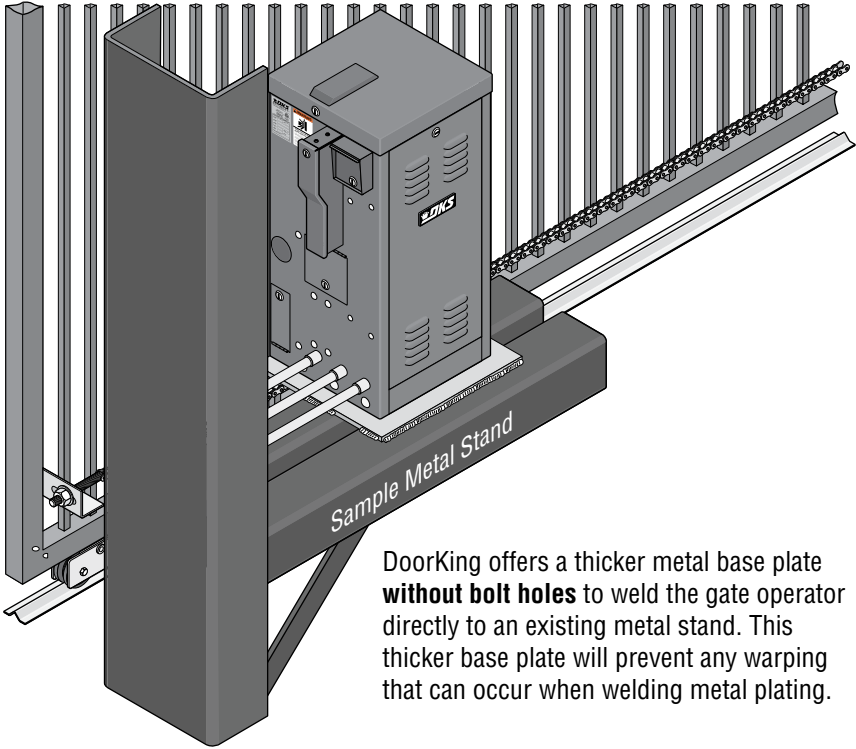

DoorKing offers a thicker metal base plate **without bolt holes** to weld the gate operator directly to an existing metal stand. This thicker base plate will prevent any warping that can occur when welding metal plating.



Important: Gate Operator **MUST** be parallel to gate!

Position gate operator to allow enough space on this side to remove/open access panels for maintenance.

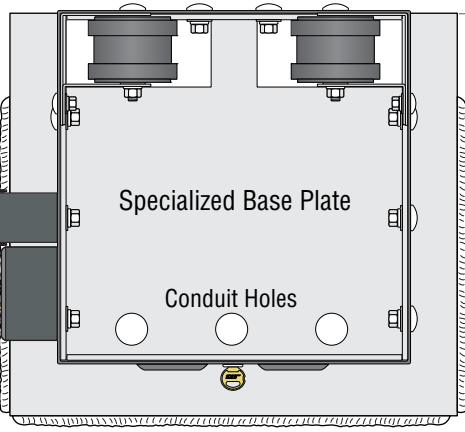

Weld around base plate, as much as possible.



- Conduit suggestions:
- High voltage conduit
 - Low voltage access control device conduit
 - Automatic exit loop conduit
 - Reverse loop conduit

DoorKing recommends using 3/4-inch conduit.

Drill holes through operator housing where needed avoiding internal structure and components.

1.6 Chain Tray Kit Installation

A chain tray is recommended for gates longer than 20 ft. to support the weight of the chain. DoorKing offers a chain tray kit in sections to fit any length gate. (DoorKing P/N 2601-270 10 Ft. section)

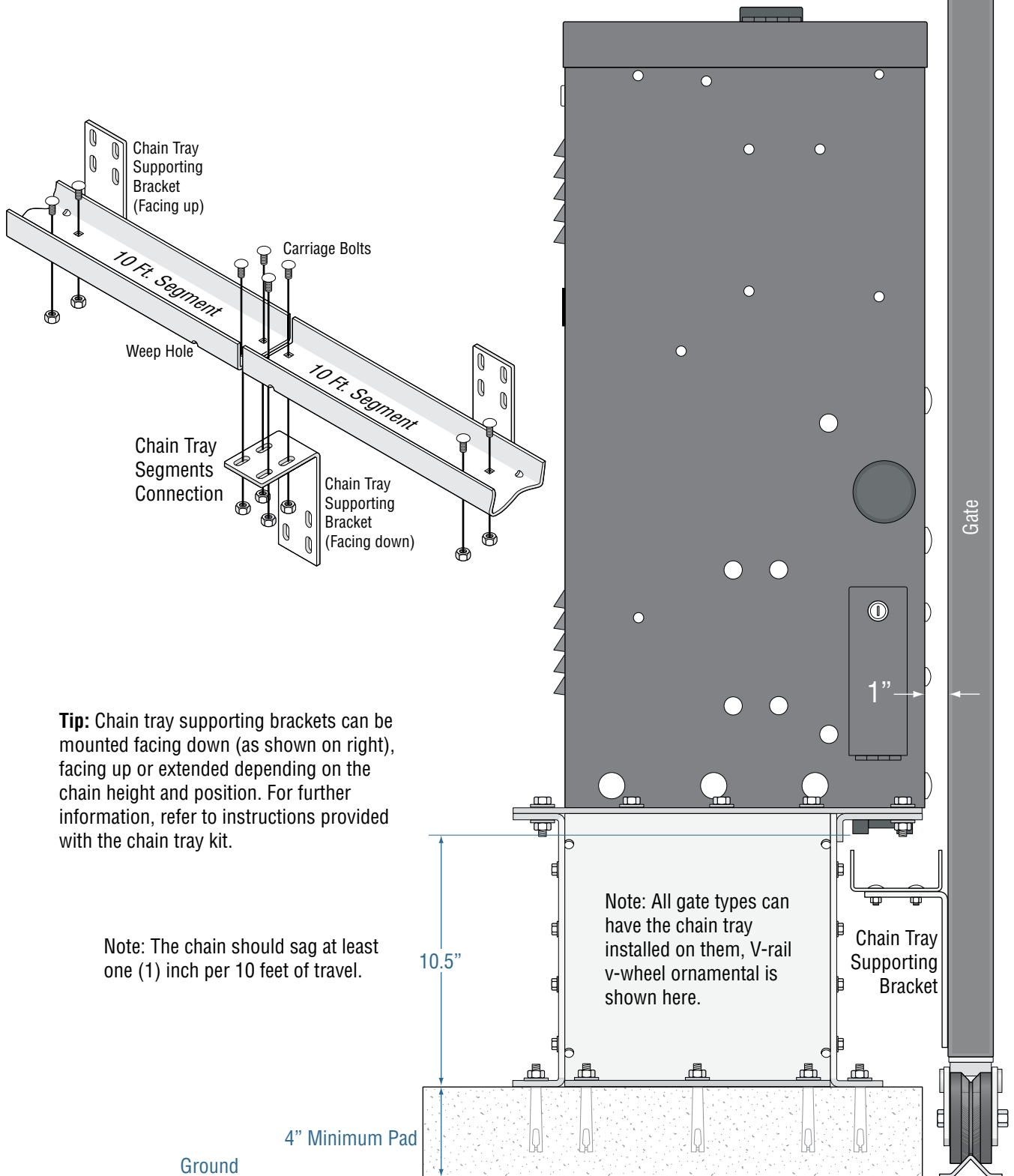

1.7 Chain Installation

Be sure to **follow ALL 3 guidelines** for either model 9245. Installing the chain in any other manner will cause excessive noise, chain idler wheel wear and chain stretching.

1 Operator **MUST** be parallel to gate!

2 Chain brackets **MUST** align with idler wheels so chain stays parallel to gate!

3 Chain brackets **MUST** be mounted so the chain remains the same height as it is on the idler wheels!

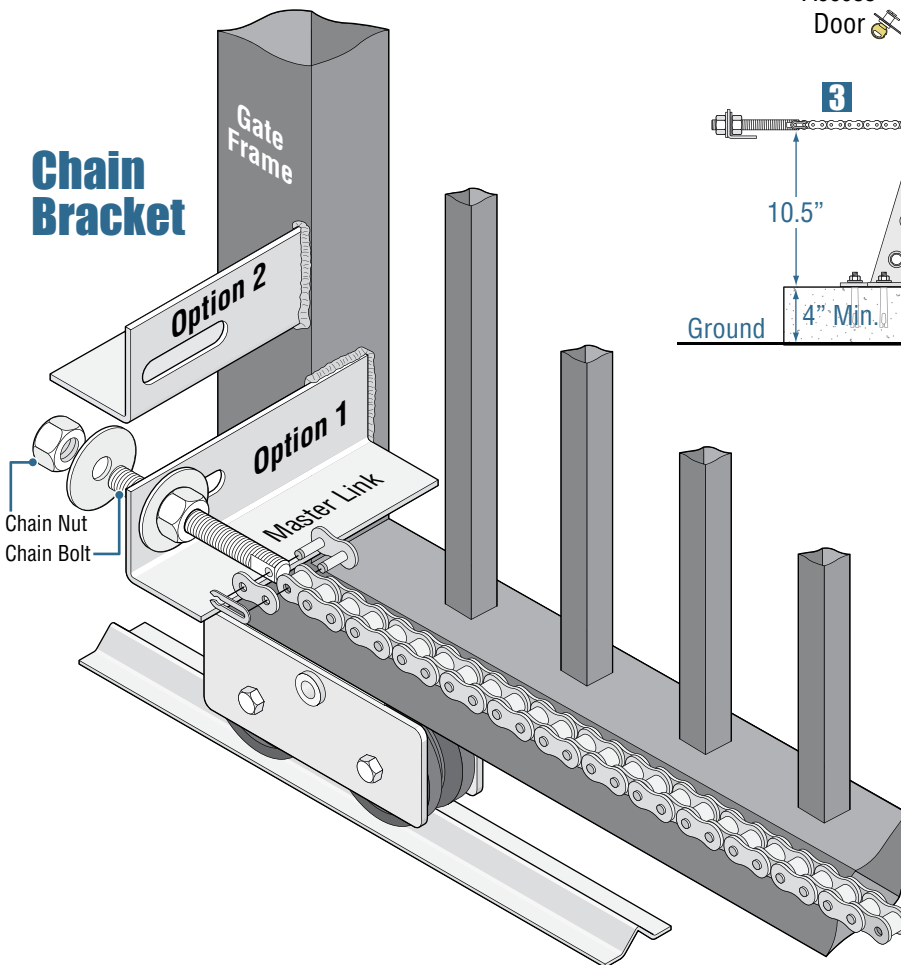
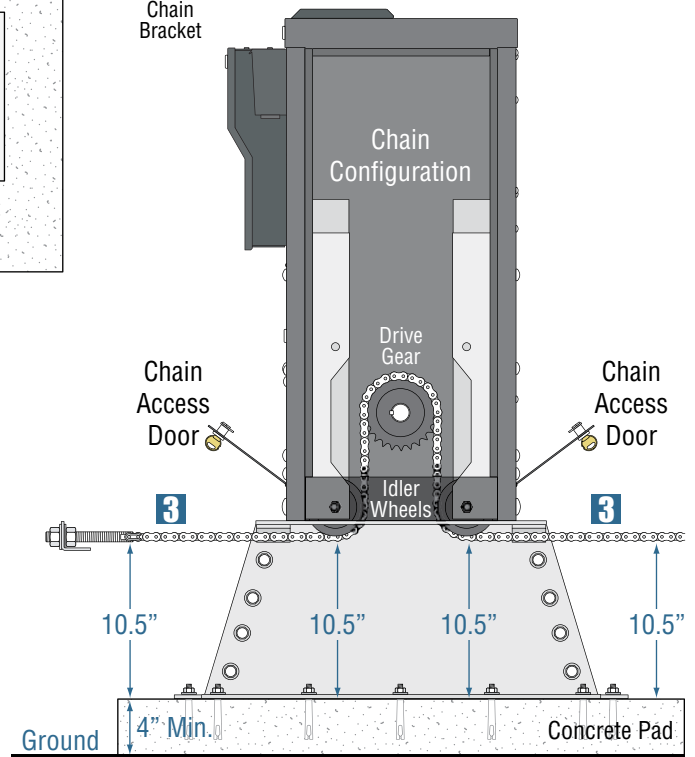
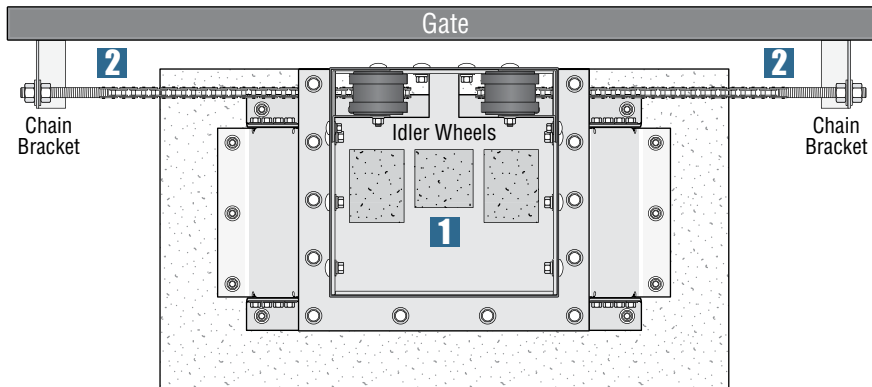

Connect Chain Bracket to Gate.

Weld completely around bracket. Chain nut and chain bolt should not protrude past gate frame.

Connect Chain to Chain Bracket.

Connect chain to chain bolt with master link. Adjust the chain nuts to tighten the chain. The chain should sag no more than one (1) inch per 10 feet of travel. Do not over tighten the chain.

1.8 Installation of Warning Signs

This DoorKing Slide Gate Operator is shipped with two warning signs. The purpose of the warning sign is to alert uninformed persons, and to remind persons familiar with the gate system, that a possible hazard exists so that appropriate action can be taken to avoid the hazard or to reduce exposure to the hazard. See page 3 for typical placement of signs.

- Warning signs are to be permanently installed in the area of the gate in such a manner that at least one warning sign is visible by persons located on each side of the gate, for both the secure and unsecure sides of the gate.
- Use appropriate hardware such as wood or sheet metal screws (not supplied) to install the warning signs.

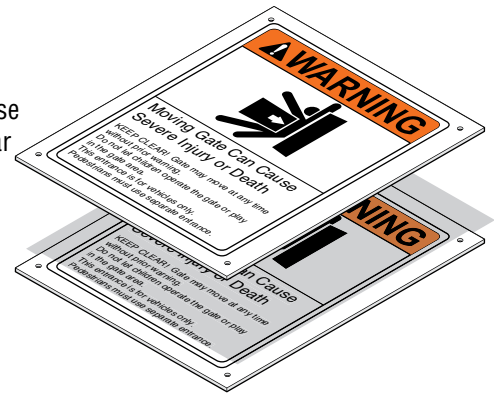

SECTION 2 - AC/DC OPERATOR(S) POWER

Before attempting to connect any wiring to the operator, be sure that the circuit breaker in the electrical panel is in the OFF position. Permanent wiring must be installed to the operator as required by local electrical codes. It is recommended that a licensed electrical contractor perform this work.

Since building codes vary from city to city, we highly recommend that you check with your local building department prior to installing any permanent wiring to be sure that all wiring to the operator (both high and low voltage) complies with local code requirements.

THIS GATE OPERATOR MUST BE PROPERLY GROUNDED!!

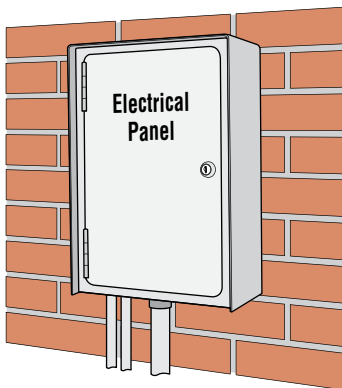

Ground to existing electrical system.

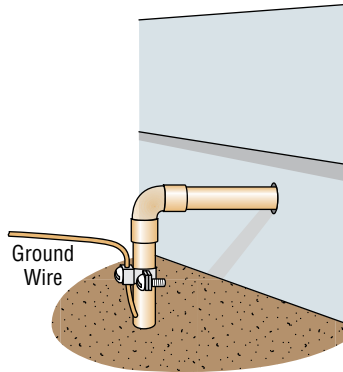

Ground to metallic cold water pipe.

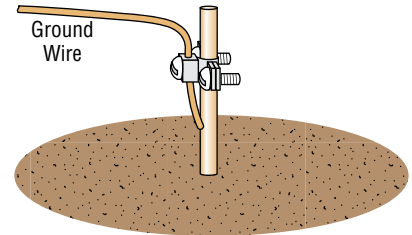

Grounding rod 10 feet in soil.

Typical Grounding Sources

IMPORTANT: Ground wire shown without safety protection for clarity. Make sure ground wire is protected from being touched or electrical shock could occur!

2.1 High Voltage Wire Runs

The 9245 draws significant power and **each** operator should have a “Dedicated” circuit breaker at the power source. If power wiring is greater than the maximum distance shown, it is recommended that a service feeder be installed. When large gauge wire is used, a separate junction box must be installed for the operator connection. The wire table is based on stranded copper wire. Wire run calculations are based on the NEC recommended maximum 3% voltage drop on the power line, plus an additional 10% reduction in distance to allow for other losses in the system.

Never run low voltage rated wire insulation in the same conduit as high voltage rated wire insulation.

		Amps	Wire Size / Max Distance in Feet			
			12 AWG	10 AWG	8 AWG	6 AWG
Single Phase	9245 Single 3 HP: 208 VAC	12.8	150	240	400	600
	9245 Single 3 HP: 230 VAC	12.6	170	270	450	680

“Optional” Heater Installation Note: When installing a heater, refer to the “high voltage AC power wire size and distance limitations” table on the instruction sheet with the heater kit for AC power wire run limitations.

2.2 High Voltage Power Connection and Battery Power

- Route incoming AC power wire through the high voltage conduit and run wire in the operator electronic box as shown.
- Be sure wiring is installed in accordance with local codes. Be sure to color code all wiring.
- It is recommended that a surge suppressor be installed on the high voltage power lines to help protect the operator and circuit board from surges and power fluctuations.
- Dual operators (Primary/Secondary) require AC power to **EACH** operator.

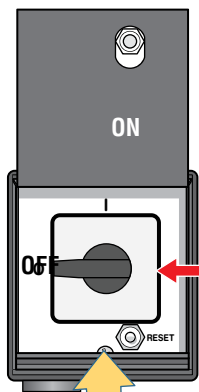
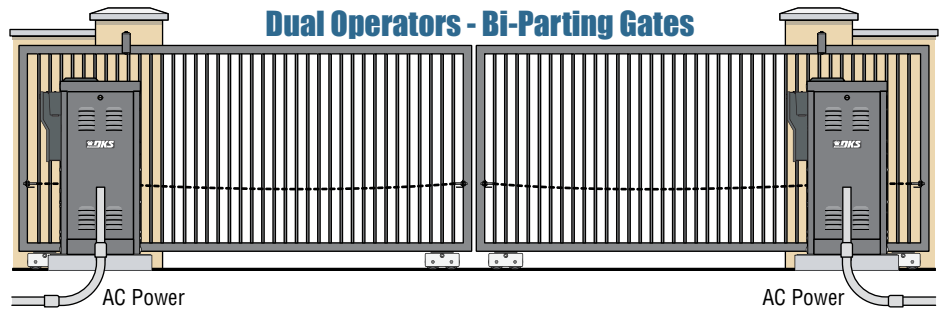

EXTERNAL ENTRAPMENT PROTECTION MUST be connected or the gate operator WILL NOT function.

DO NOT power up and cycle the operator until the “DIP-Switches” and the “Limit Switches” have been adjusted. **Damage could occur to the gate and operator.**

External Power Disconnect Switch

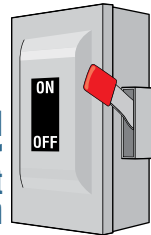

A **separate** power disconnect switch may be needed in your area. Check local building codes before installation. Recommended by DoorKing.



AC Power Terminal

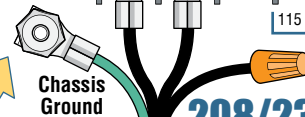
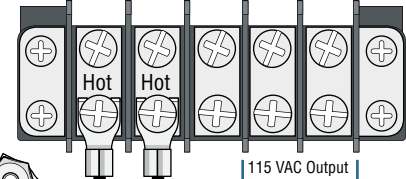

208/230 VAC SINGLE Phase

Use only two legs of the incoming 3-phase power.

VERIFY Input AC power **MATCHES** your specific operator power **BEFORE** wiring!

Battery Power

The mechanical disc brake uses a DC powered solenoid to **automatically** release the brake (Fail-Safe) when power is cut off to gate operator. The battery is trickle charged using a power transformer connected to one of the 115 VAC convenience outlet.

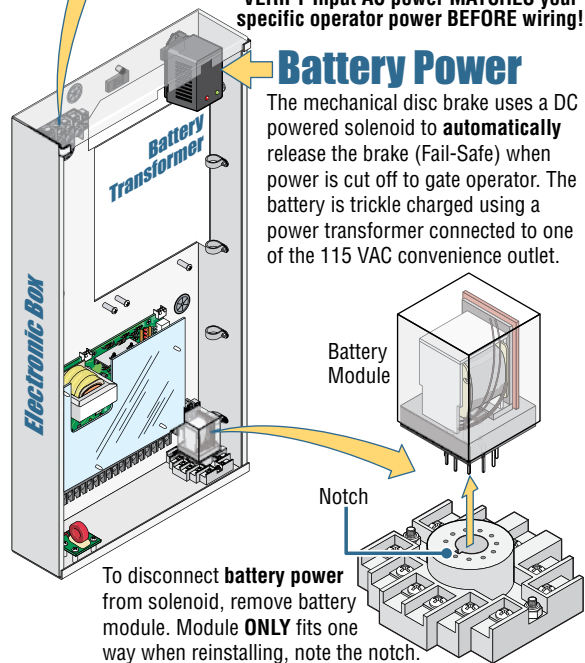

High Voltage AC Input Wire

- 1 Remove the 3 locknuts inside the electronic box to swing box open.
- 2
- 3

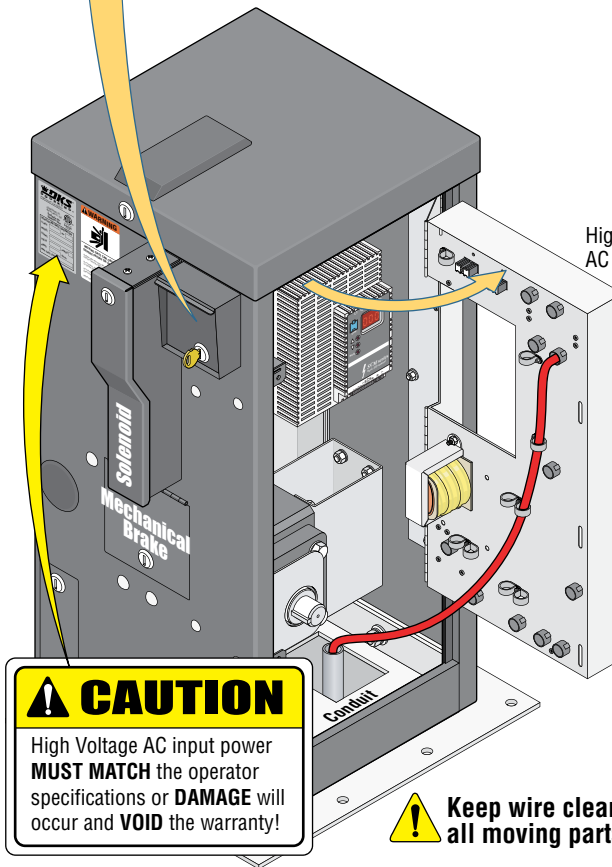

CAUTION

High Voltage AC input power **MUST MATCH** the operator specifications or **DAMAGE** will occur and **VOID** the warranty!

Keep wire clear of all moving parts.

SECTION 3 - ADJUSTMENTS

The switch settings and adjustments in this chapter should be made after your installation and wiring to the operator(s) is complete. **Whenever any of the programming switches on the circuit board are changed, power must be shut-off, and then turned back on for the new setting to take effect.**

3.1 Circuit Board Description and Adjustments

LEDs Indicates that low voltage power is applied to the circuit board. **Input LEDs** should be OFF and will only illuminate when the input is activated. **Limit LEDs** will be on when the respective limit switch is activated.

Single Channel Loop Detector

See page 26.

Dual Channel Loop Detector

AC Module Adjustment

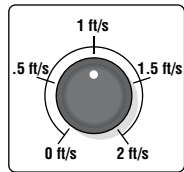

Min Max Speed
See page 22.

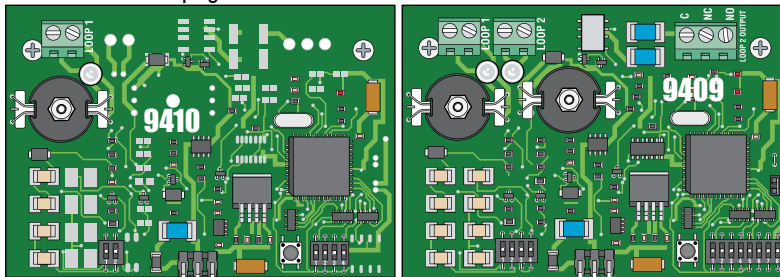

Reverse Loop Port

Limit Switch Plug P2

Exit Loop Port

Mechanical Disc Brake Plug P8

Motor Plug P6

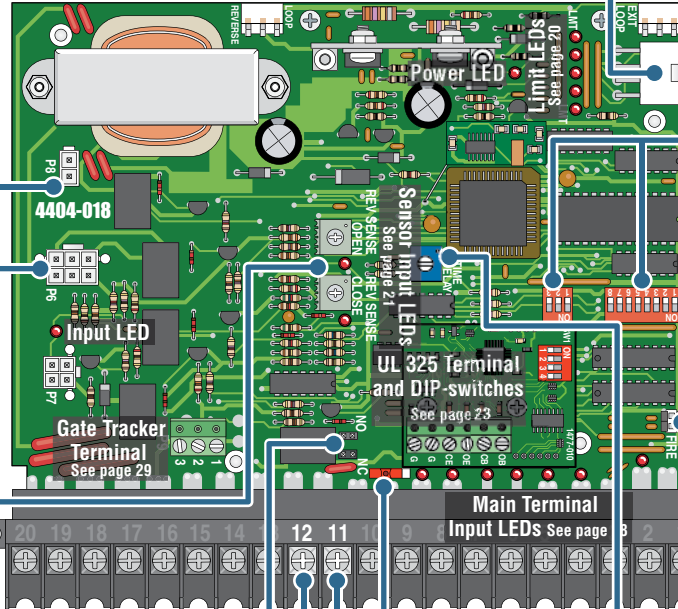

DIP-Switches

Set the DIP-switches on the circuit board to the desired setting. See switch descriptions on next 2 pages.



SW 2 is Upside-Down on Board

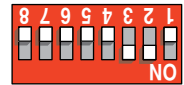

SW 1 is Upside-Down on Board

Fire Dept Open

Connect **ONLY** emergency access controls accessible by authorized personnel (e.g., fire, police, EMS). Upon activation, alarm will sound and the operator will go into a **hard shutdown** after reaching the open limit. Operator must be reset to resume normal operation. See pages 28, 32.

Inherent Reverse Sensors

Adjust reversing sensitivity for open and close directions. Full counter clockwise for minimum sensitivity, full clockwise for maximum sensitivity. See page 21.

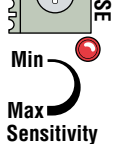
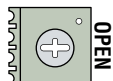

Dry Relay Contact

Dry relay contacts (terminals 11-12) can be set for Normally Open (NO) or Normally Closed (NC) operation by placing the relay shorting bar on the N.O. or N.C. pins respectively. SW 1, switches 4 and 5 must be set to control relay. See next 2 pages for descriptions.

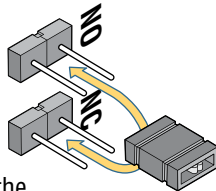

Self-Test

Self-test (when turned on)
SW 2, switch 1.



SW 2 is Upside-Down on Board

CAUTION Do not run self-test with the operator connected to the gate. The drive chain **MUST** be disconnected before running the self-test. This feature is designed for bench testing **ONLY**.

Auto-Close Timer

Auto-close timer (when turned on) SW 1, switch 2. Adjust from 1 second (full counter-clockwise) to approximately 23 seconds (full clockwise).

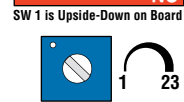

3.2 DIP-Switch SW 1 and SW 2 Settings

The two DIP-switches located on the circuit board are used to program the operator to operate in various modes and to turn on or off various operating features. Whenever a switch setting is changed, power to the operator must be turned OFF and then turned back on for the new setting to take affect. Check and review ALL switch settings prior to applying power to the operator.

Left 3 Switches - SW 2
SW 2 is Upside-Down on Circuit Board.



Typical Settings

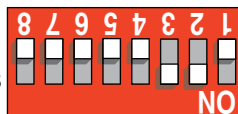

SW 1 - Right 8 Switches
SW 1 is Upside-Down on Circuit Board.

SW 1 - Right 8 Switches			
Switch	Function	Setting	Description
1	Changes the direction the operator will open/close the gate.		
2	Auto-Close Timer	OFF	Auto-close timer is OFF. Manual input required to close gate.
		ON	Auto-close timer is ON. Adjustable from 1-23 seconds to close gate.
3	Exit Loop Port Output	Jumper Wire Needed OFF	The output wired to terminal #4 becomes the output from the loop detector installed in the EXIT loop port. Plug-in loop detector required for "OFF" function.
	Full Open Input	ON	Normal Setting. Terminal #4 is a normal full open input for a single gate operator.
4 and 5	Relay Activation and LED Indicator Light Activation	4-OFF 5-OFF	Relay activates and LED is ON when the gate is fully open.
		4-OFF 5-ON	Relay activates and LED is ON when the gate is not closed.
		4-ON 5-OFF	Relay activates and LED is ON when the gate is opening and open.
		4-ON 5-ON	Relay activates and LED is ON when the gate is opening and closing.
6	Warn Before Operate	OFF	Internal alarm will NOT sound.
		ON	Internal alarm will sound before gate starts and throughout gate's cycle.
7	Reverses Gate	OFF	Normal Setting. Input to terminal #6 and/or reverse loops will REVERSE gate during CLOSE cycle.
	Stops Gate	ON	Input to terminal #6 and/or reverse loops will STOP gate during CLOSE cycle.
8	Quick-Close Timer Override	OFF	Normal Setting. Timer will function normally.
		ON	Opening gate will stop and begin to close as soon as all reversing inputs (Reverse loops, photo sensors) are cleared regardless of the distance the gate has opened.

SW 2 - Left 3 Switches			
Switch	Function	Setting	Description
1	Self-Test	OFF	Normal Setting. Normal gate operation.
		ON	Self-test mode. Operator MUST be disconnected from gate to run self-test.
2	Gate Opens Uphill	OFF	Normal Setting. Normal gate operation.
		ON	MUST be ON if gate opens UPHILL.
3	Gate Opens Downhill	OFF	Normal Setting. Normal gate operation.
		ON	MUST be ON if gate opens DOWNHILL.

3.2 Continued

The two DIP-switches located on the circuit board (Upside-Down) are used to program the operator to operate in various modes and to turn on or off various operating features. Whenever a switch setting is changed, power to the operator must be turned OFF and then turned back on for the new setting to take affect. Check and review ALL switch settings prior to applying power to the operator.

Switch Definitions

Typical Settings

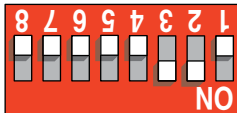

SW 1 - Right 8 Switches

SW 1 is Upside-Down on Circuit Board.

Switch 1 Motor direction switch - **Must** OPEN the gate upon initial AC power up and open command. If the open command begins to close the gate, turn AC power off and reverse this switch.

Switch 2 Turns the auto-close timer on or off. Can be adjusted from 1 to 23 seconds to close gate.

Switch 3 A device wired to terminal #4 (Switch 3 **ON**) is a normal full open input. The output wired to terminal #4 (Switch 3 **OFF**) becomes the output of a plug-in loop detector that is installed in the EXIT loop port of the circuit board (Which must be installed for the “**OFF**” setting to function). A jumper wire is needed to open and close gate(s). Terminal #4 jumpered to #5 is used for **partially** opening an automatic exit loop using a **single channel** plug-in loop detector for a single gate operator (Page 26) **OR** terminal #4 jumpered to #2 will **fully** open bi-parting gates using a **dual channel** plug-in loop detector (Page 32).

Switches 4-5 These work in conjunction with each other and determine when the relay on the board will be activated. This relay can be used as a switch for various functions such as illuminating a warning light when the gate is moving, or turning on a green light when the gate is full open. If a magnetic lock is used with the gate operator, these switches must be set for magnetic lock operation which limits the relay to activate only when the gate is opening and full open.

Switch 6 Warn Before Operate, When set to the **ON** position, the internal alarm in the operator will start sounding 2-3 seconds prior to the gate starting and continue throughout the gate’s cycle.

Switch 7 Determines if an input to terminal #6 (e.g.: Normally Open-N.O. Photo Sensors, **NOT** entrapment protection) **AND/OR** reverse loops will reverse **OR** stop a **CLOSING gate**. A tailgating vehicle **can activate** terminal #6 and/or reverse loops **while** the gate is in the closing cycle from the previous vehicle’s authorized entry:

If switch 7 is turned **OFF** (Reverse), the closing gate that gets activated by a tailgating vehicle will reverse back to the open position, possibly allowing the tailgating vehicle **unauthorized entry while the gate is reversing back to the open position**.

If switch 7 is turned **ON** (Stop), the closing gate that gets activated by a tailgating vehicle will stop, partially or completely blocking the pathway, **NOT** allowing the tailgating vehicle to enter without proper authorization. The gate will not move until all sensors are clear, usually forcing the tailgating vehicle that activated the sensors to back away from the gate. The gate will then continue until closed, helping prevent the tailgating vehicle from unauthorized entry.

Switch 8 Turning the quick-close feature on will cause the auto close timer to close the gate after 1 second, regardless of the setting of the auto close timer potentiometer. This will also cause an **opening gate** to stop and reverse when the reverse loops and/or N.O. photo sensors are cleared. This feature, along with turning switch 7 **ON** above, is useful to help prevent tailgating vehicles from unauthorized entry.

Typical Settings



SW 2 - Left 3 Switches

SW 2 is Upside-Down on Circuit Board.

Switch 1 This switch is a self-test feature that checks various functions of the circuit board and is used for bench test only. **Do not run this test with the operator connected to the gate.**

Switch 2 Set to the OFF position for normal operation. Set to the ON position if gate OPENS in an UPHILL direction.

Switch 3 Set to the OFF position for normal operation. Set to the ON position if gate OPENS in an DOWNHILL direction.

3.3 Limit Switches

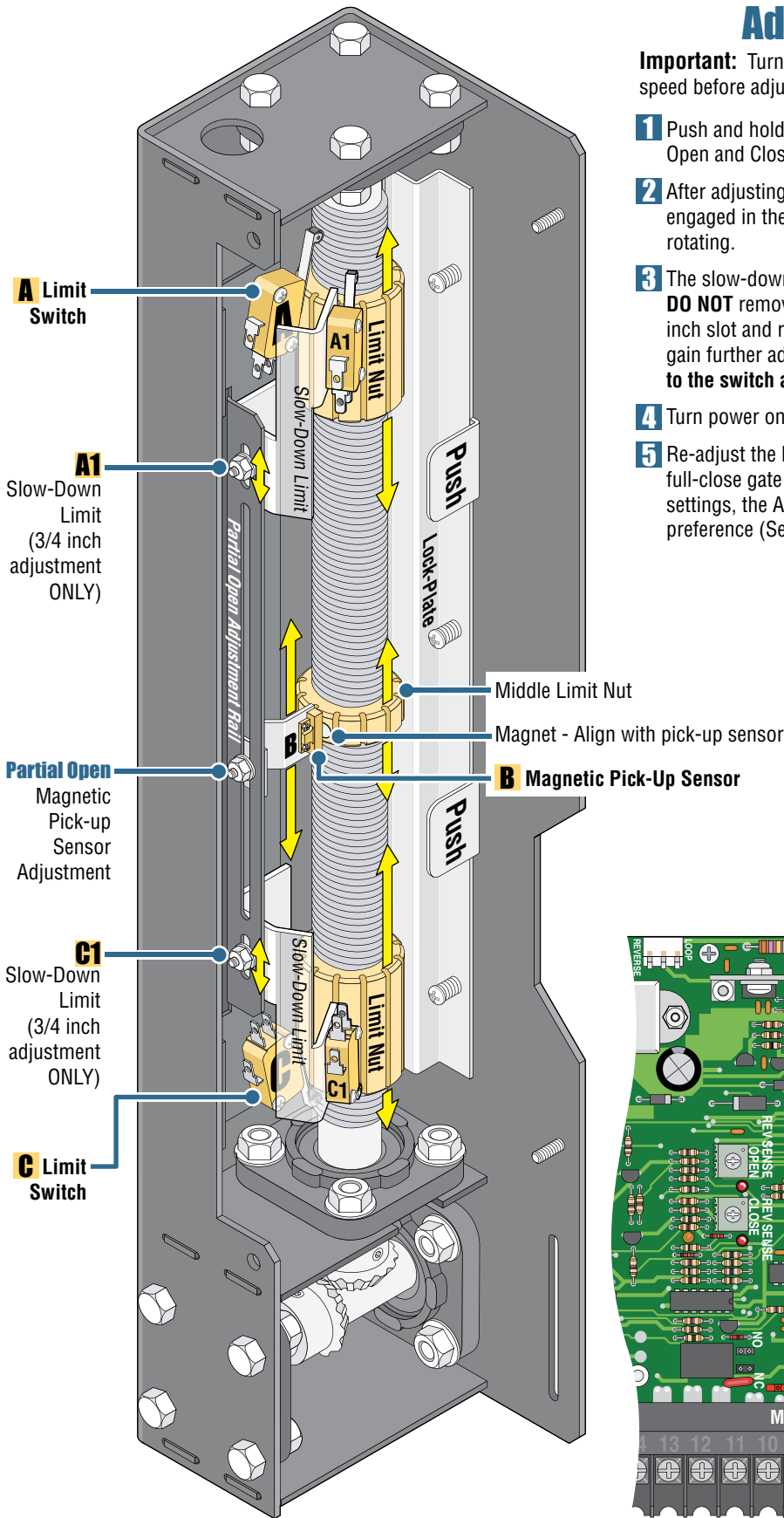

Adjust Limit Nuts

Important: Turn power **OFF** and set AC module to maximum speed before adjusting limit nuts!

- 1** Push and hold the lock plate down where shown to adjust the Open and Close limit nuts.
- 2** After adjusting the limit nuts, be sure that the lock-plate is engaged in the slots on the limit nuts to prevent them from rotating.
- 3** The slow-down limit assembly will move up or down 3/4 inch. **DO NOT** remove the slow-down limit assembly from the 3/4 inch slot and re-attach it in the partial open adjustment rail to gain further adjustment. **This will cause mechanical damage to the switch assembly when the operator is activated.**
- 4** Turn power on and activate the gate operator.
- 5** Re-adjust the limit nuts as necessary for full-open and full-close gate travel. After you are satisfied with the gate limit settings, the AC module can then be adjusted to personal preference (See page 22).

Partial Open Feature: When using the partial open feature, the operator's access control device must be connected to terminal #5 ⚠️. Adjust the middle limit nut and magnetic pick-up sensor assembly to the gate's desired stopping position. Be sure to align the magnet (Recessed in the limit nut) with the magnetic pick-up sensor.

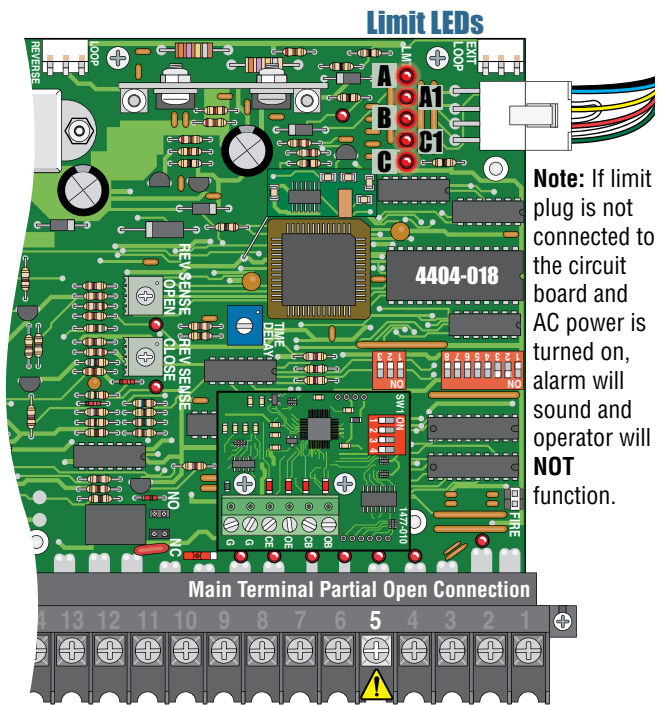

Note: If limit plug is not connected to the circuit board and AC power is turned on, alarm will sound and operator will **NOT** function.

3.4 Inherent Reverse Sensors Adjustment

This vehicular gate operator is equipped with an inherent adjustable reversing sensor (Type A) used as entrapment protection according to UL 325 standards. **The gate will reverse direction after “physically” encountering an obstruction in either the opening or closing gate cycle.**

If the Auto-Close Timer (DIP-switch SW 1, switch 2) is ON and the gate physically encounters an obstruction during the **CLOSING** cycle, it will reverse to the open position and **HOLD** the gate at this position (Soft shutdown condition). Another input command is needed before the gate will reset and close again.

If the Partial Open Feature is being used and the gate physically encounters an obstruction during the **CLOSING** cycle, the gate will only reverse to the **FULL** open limit switch setting and **NOT** the partial open setting.

For the reverse system to function correctly, the gate must be properly installed and work freely in both directions and the limit switches must be properly adjusted before adjusting these sensors. The ideal adjustment will allow the operator to move the gate through its entire travel cycle without reversing, but will reverse upon contact with an obstruction with no more than 40 Lbs of force. This force can be measured with a gate scale.

- 1** Momentarily jumper a wire across terminals 1 and 4 to OPEN the gate.
- 2** After opening gate reaches full speed, slowly rotate the OPEN reverse sensor clockwise until the LED lights up and gate reverses direction. Rotate the OPEN reverse sensor back counter-clockwise approximately 1/8 turn to decrease the sensitivity (LED will turn off). The gate will assume a soft shutdown so momentarily jumper a wire across terminals 1 and 4 to cycle the operator.
- 3** Momentarily jumper a wire across terminals 1 and 4 to CLOSE the gate.
- 4** After closing gate reaches full speed, slowly rotate the CLOSE reverse sensor clockwise until the LED lights up and the gate reverses direction. Rotate the CLOSE reverse sensor back counter-clockwise approximately 1/8 turn to decrease the sensitivity (LED will turn off). The gate will assume a soft shutdown so momentarily jumper a wire across terminals 1 and 4 to cycle the operator.
- 5** Cycle the gate a few times to be sure that it cycles completely. The current sensor may need to be adjusted if gate will not reverse properly (See 3.5 below)

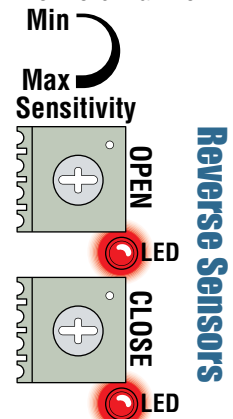

Note: Each operator must be individually adjusted if dual operators have been installed.

Test the operator reversing sensitivity:

Place an immobile object along the gate path, allowing the gate to strike it while in the **open** and **close** cycles. The gate must reverse direction after striking the object. If it does not, increase the OPEN and CLOSE reverse sensitivity (steps **2** and **4**) and repeat this testing until the correct sensitivity has been achieved in **BOTH** directions. The operator will assume a soft shutdown after striking and reversing the gate which will require a momentary jumper wire across terminals 1 and 4 to cycle the operator again.

3.5 Current Sensor Adjustment

This vehicular gate operator uses a current sensing device to detect any obstructions in the path of the opening or closing gate. The current sensor uses a sensing coil with a given number of turns through it to monitor the current flow into the operator. Each time the wire passes through the coil, it is considered a turn. The number of turns through the sensing coil is dependant on the operating voltage of the operator, the speed of the gate and the weight of the gate.

In general, light weight gates may require additional turns of wire through the current sensor, while heavier gates may require less turns. In addition, the speed of the gate can affect how the current sensor works. Gates running at a higher speed may require less turns of wire through the sensor. **CAUTION – HIGH VOLTAGE:** Be sure power is turned OFF before changing the number of wire turns to the current sensor. If you are setting the reverse sensors (section 3.4 above) and reach the full sensitive position without activating the reversing function, add an additional turn of wire through the current sensor. If you are decreasing the sensitivity and the gate will not run properly, reduce the number of turns through the current sensor.

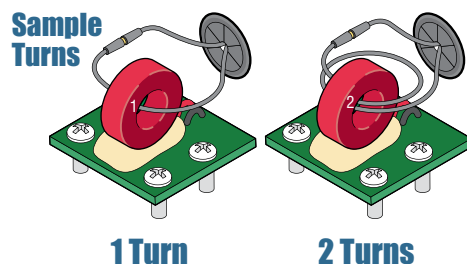

Voltage and Phase	Turns
208 Single Phase	2
230 Single Phase	2

3.6 AC Module Adjustment

The 9245 model is equipped with an AC module that allows you to adjust the speed of the gate from 0 to 2 feet per second. To adjust the speed, simply rotate the speed control knob clockwise to increase the gate speed, or counter-clockwise to decrease the gate speed. The digital readout on the AC module will display the gate speed.

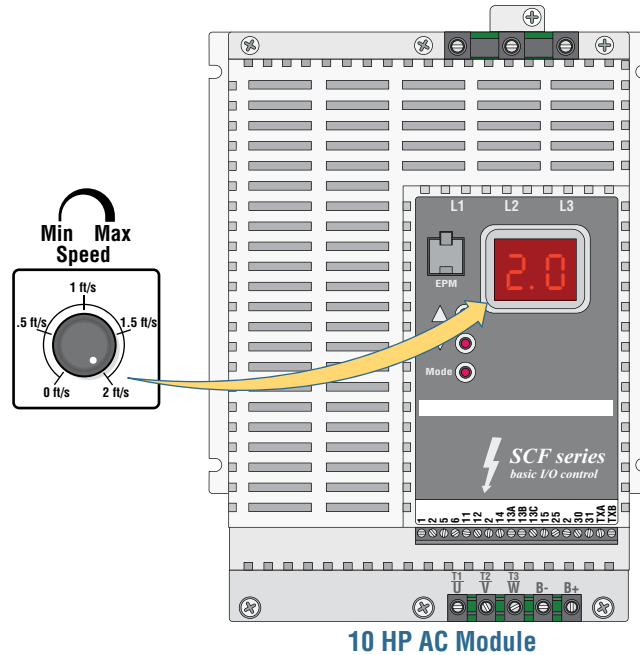

SECTION 4 - ENTRAPMENT AND SAFETY PROTECTION

External Entrapment Protection Devices:

In addition to the inherent reversing sensor system, this operator has a UL 325 terminal for the connection of **photo sensors**-Type B1 and/or **reversing edges**-Type B2 entrapment protection required by UL 325 standards. **Entrapment Protection must be provided for the gate system where the risk of entrapment or obstruction exists. The operator will NOT run without one or more monitored type B1 or B2 external entrapment protection devices installed in EACH direction of gate travel (minimum of 2 external devices required).** Install these devices where the risk of entrapment or a safety hazard exists, examples of which are shown below and the next 2 pages. Installations can vary.

4.1 UL 325 Terminal Description

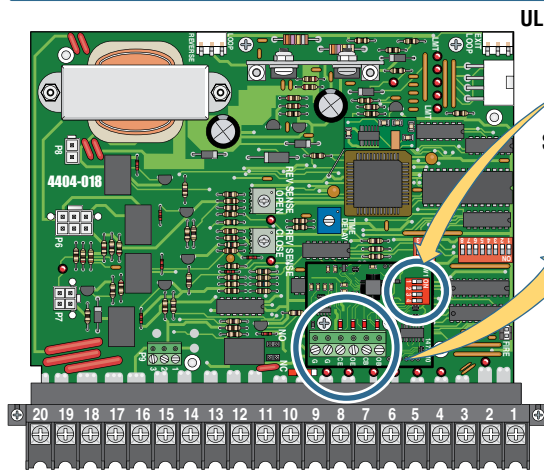

UL 325 DIP-Switches



DIP-switches **MUST** be turned **ON** for each device wired to terminal.

Sensor LEDs

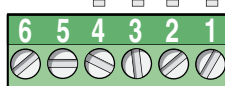

OB OPEN Beam STOP (Switch 1)
 CB CLOSE Beam REVERSE (Switch 2)
 OE OPEN Edge/Beam REVERSE (Switch 3)
 CE CLOSE Edge/Beam REVERSE (Switch 4)
 G Ground (Common)
 G Ground (Common)

6-Pin UL 325 Terminal

Entrapment Protection Device Connection.

ONLY connect monitored devices.

One 115 VAC Convenience Outlet

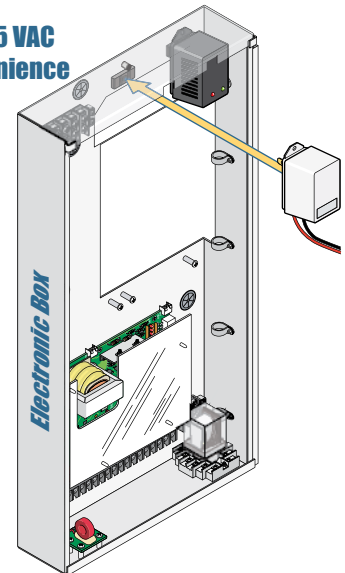

Sensor LEDs Note:

LED ON: Connected device has been activated. LED remains off during normal operation.

LED Flashing: Connected device is in fault. Wiring to device is bad.

Monitored Device Note: Only 1 monitored Device can be connected to each input. An **OPTIONAL** Expansion Board (sold separately) will allow connection for additional devices.

1 OPEN Beam Stop: Obstructed opening-direction photo beam will stop the gate **during the opening-direction only**. Gate will resume the open cycle when the obstructed photo beam has been cleared.

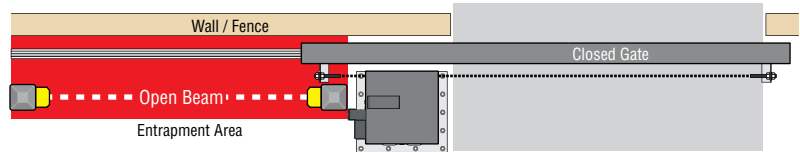

2 CLOSE Beam Reverse: Obstructed closing-direction photo beam will reverse the gate to the open position and reset the close-timer **during the closing-direction only**. Gate will close when timer times out.

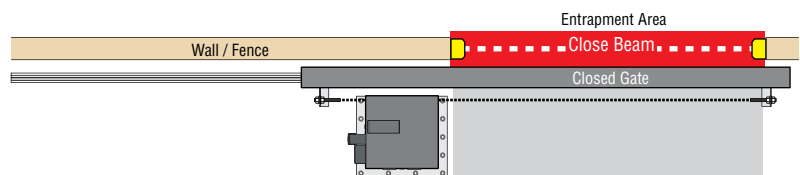

3 OPEN Edge/Beam Reverse: Obstructed reversing edge or photo beam will reverse the gate to the close position **during the opening-direction only**.

- After the gate reverses to the close position, any opening input will cycle the gate again.

Note: If the gate is opening by a time clock and a edge/beam gets obstructed, the gate will return to the closed position and another input (automatic exit loop, reverse loop, remote etc.) is needed to cycle the gate open again.

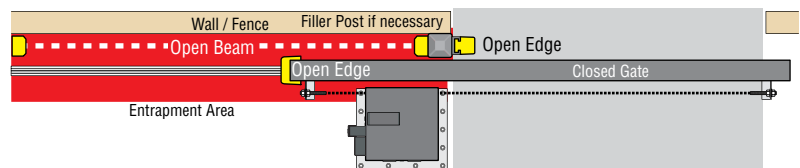

4 CLOSE Edge/Beam Reverse: Obstructed reversing edge or photo beam will reverse the gate to the open position **during the closing-direction only**.

- After the gate reverses to the open position, the close-timer will time out and close the gate (if it is turned on).
- If a second sequential obstruction is encountered prior to the gate reaching the close limit, the gate will **reverse to full open position** and enter a soft shutdown condition (See page 31).

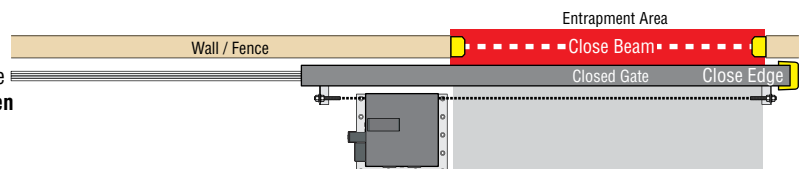

5 & 6 Ground (Common): Common terminal for all MONITORED entrapment protection device inputs.

4.2 Entrapment Protection Device Locations

Typical UL Photo Sensor mounting height and distance away from gate.

Secure Side
Inside Property

Non-Secure Side
Outside Property

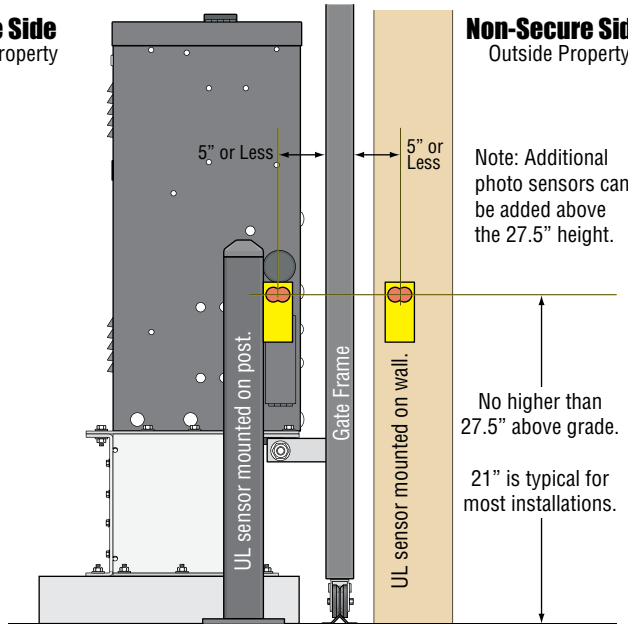
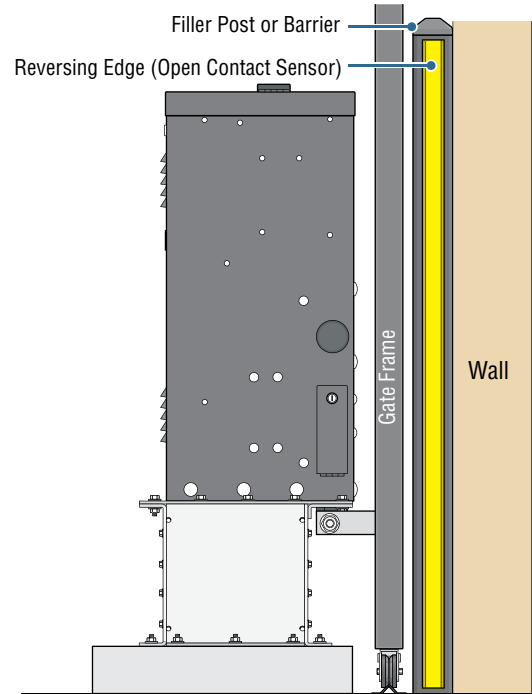

Photo sensors may be installed on either side of gate frame, as close as practical to the gate but no further away than 5".

If the distance between the gate and wall is greater than 2 1/4".



A filler post or barrier may need to be installed between the gate and wall area to reduce the distance to 2 1/4" or less. A reversing edge should be installed on the post or barrier for safety (See page 2 for more information).

Photo Sensors (With Filler Post and Reverse Edge) Sample Setup

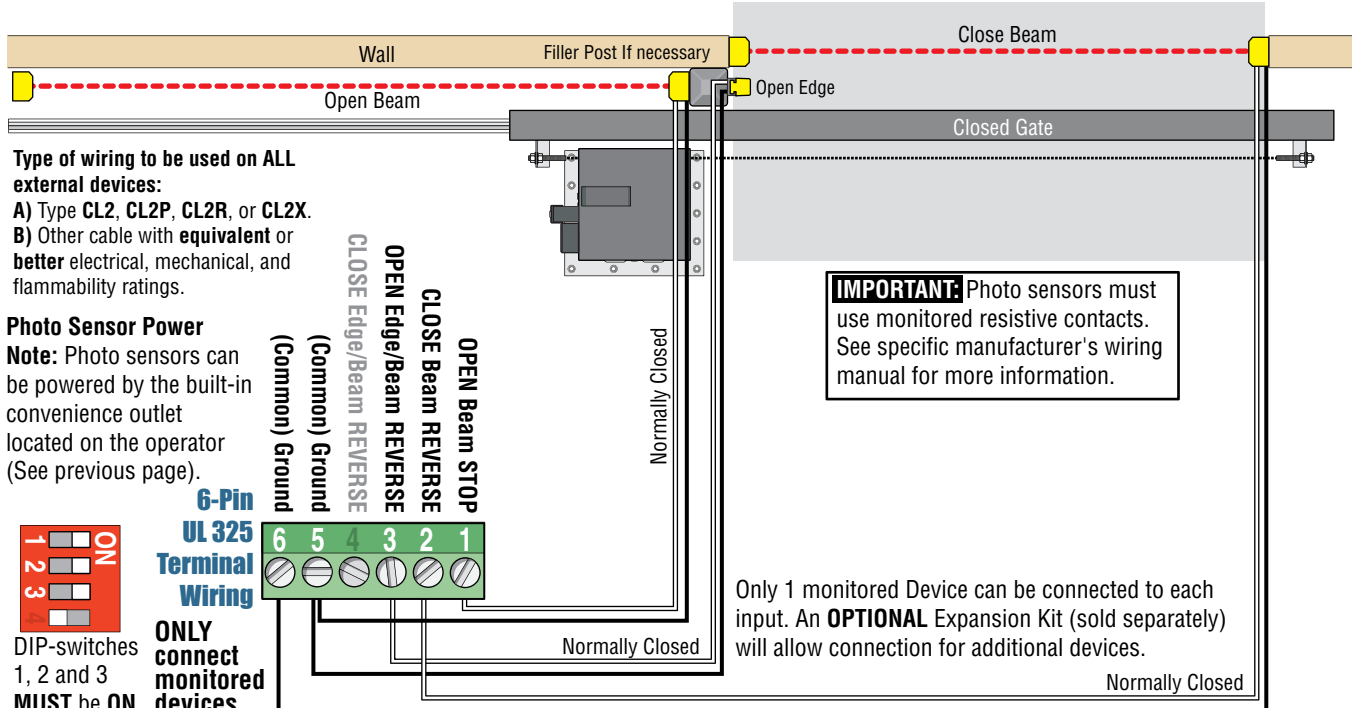

Type of wiring to be used on ALL external devices:

- A) Type CL2, CL2P, CL2R, or CL2X.
- B) Other cable with equivalent or better electrical, mechanical, and flammability ratings.

Photo Sensor Power

Note: Photo sensors can be powered by the built-in convenience outlet located on the operator (See previous page).

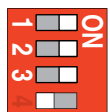

DIP-switches 1, 2 and 3 MUST be ON.

6-Pin UL 325 Terminal Wiring

ONLY connect monitored devices.

- 6 (Common) Ground
- 5 (Common) Ground
- 4 CLOSE Edge/Beam REVERSE
- 3 OPEN Edge/Beam REVERSE
- 2 CLOSE Beam REVERSE
- 1 OPEN Beam STOP

IMPORTANT: Photo sensors must use monitored resistive contacts. See specific manufacturer's wiring manual for more information.

Only 1 monitored Device can be connected to each input. An **OPTIONAL** Expansion Kit (sold separately) will allow connection for additional devices.

Wireless Reverse Edge Sample Setup - Single Receiver

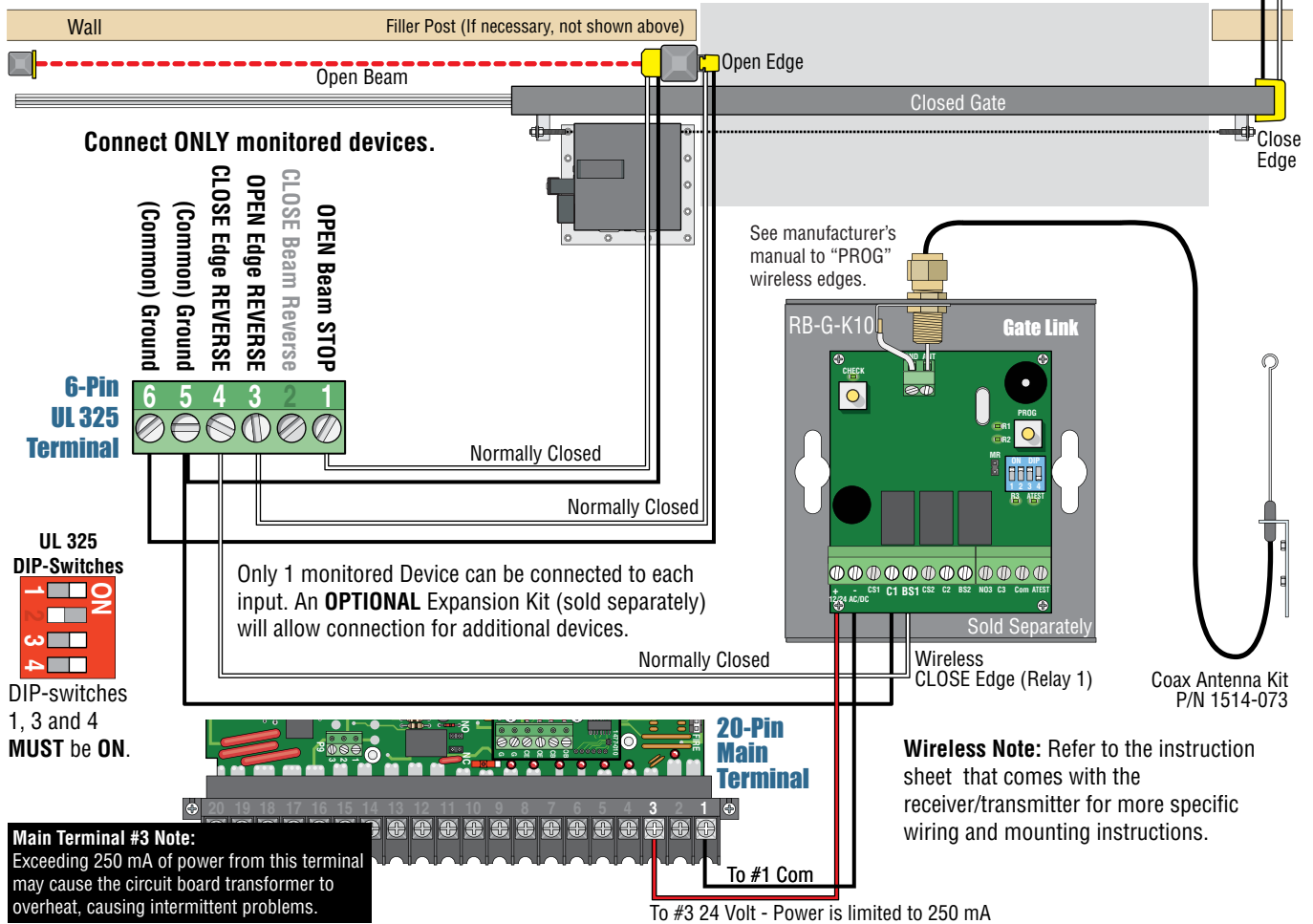
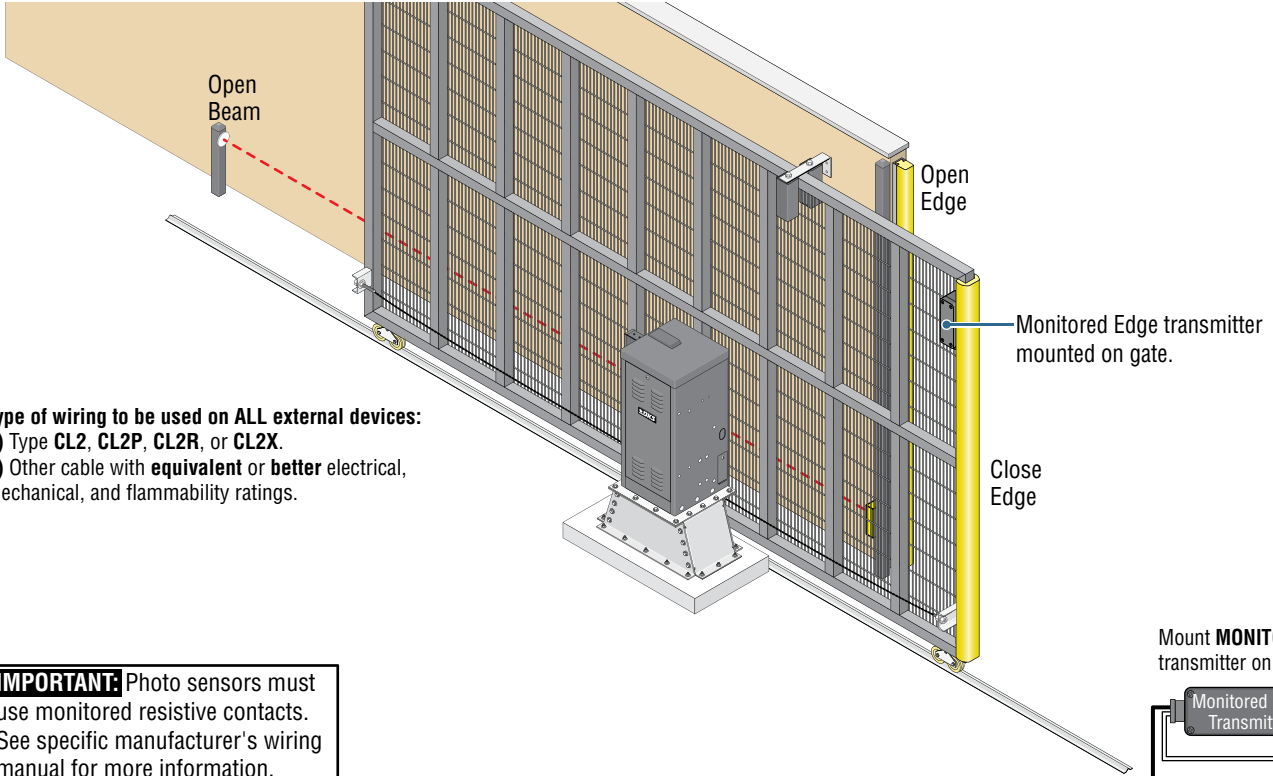

4.3 Loop Detector Wiring

To help protect the operator from accidentally closing on vehicles in the gate's path, DoorKing highly recommends that loops and loop detectors be installed. Loops are laid underneath, cut into asphalt or concrete driveways or buried beneath gravel and earth driveways. A loop detection system will sense a vehicle like a metal detector and send a signal to the gate operator preventing the gate from automatically opening or closing on a vehicle when it is in the gate's path. DoorKing recommends that a licensed installer perform this work.

DoorKing offers a free "Loop and Loop-Detectors Information Manual" PDF located at DoorKing's web site for more information. www.dkaccess.com

Reverse Loops

Reverse loops are placed on each side of the gate to prevent the gate from closing on a vehicle in the gate's path. They will stop or reverse the cycling of the gate while a vehicle is in or near the gate's pathway.

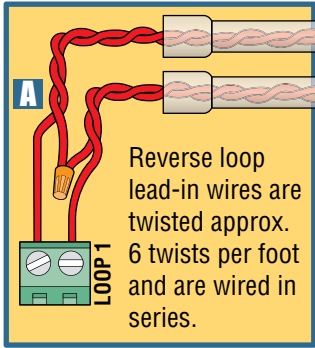

Note: SW 1, switch 7 must be set for the reverse loops. See page 19 for more information about SW 1, switch 7 ON/OFF options.

SW 1 is Upside-Down on Board

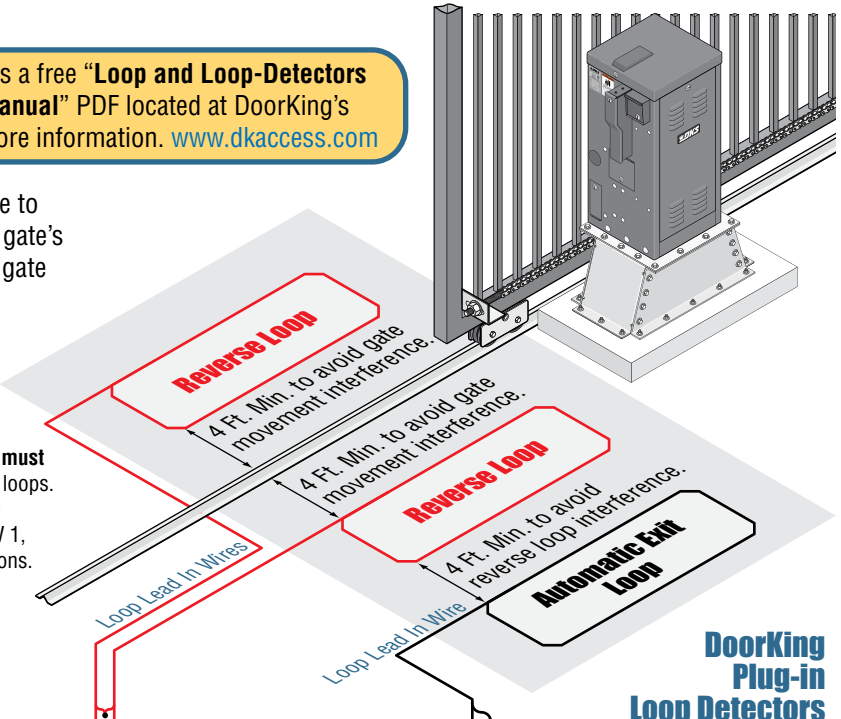

Automatic Exit Loop

Automatically opens the gate for exiting vehicles without having to use a transmitter or keypad. The exit loop can be placed a minimum of 4 feet away from the reverse loop or far enough away from the gate so the gate has started opening or even completely opened by the time you drive up to it (Free exit).

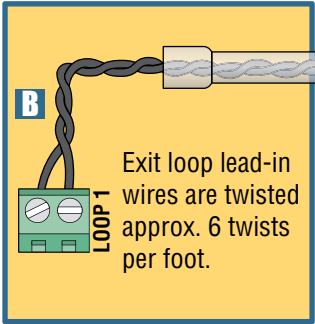

SW 1, switch 3 must be ON to FULLY open gate (Normal function).

SW 1 is Upside-Down on Board

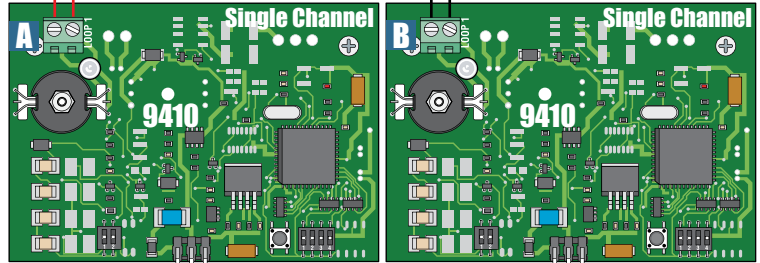

Note: The plug-in exit loop detector can be wired to **partially open** the gate if SW 1, switch 3 is turned **OFF**. A jumper wire must be connected from terminal #4 to terminal #5 (See next page for more information).

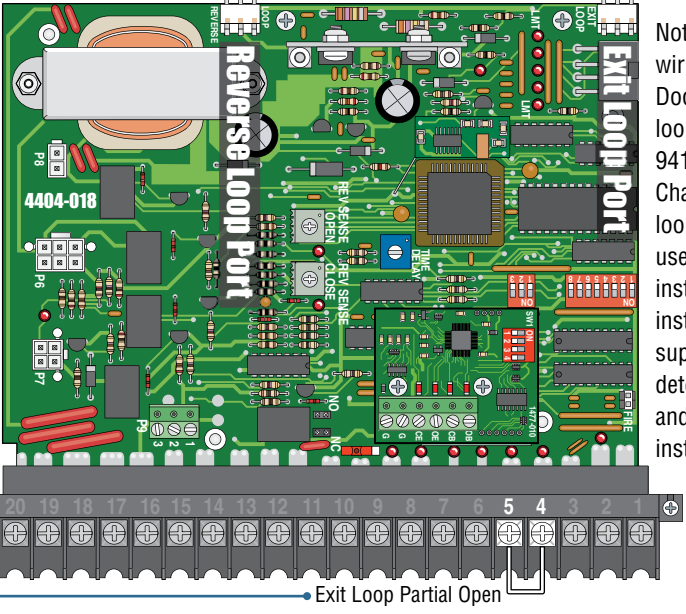
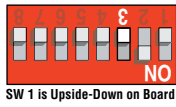

Note: Loop detector wiring is shown for DoorKing plug-in loop detector P/N 9410-010 (Single Channel). If other loop detectors are used, refer to the installation instructions supplied with those detectors for wiring and separate power instructions.

DoorKing Plug-in Loop Detectors

SECTION 5 - MAIN TERMINAL WIRING

5.1 Main Terminal Description

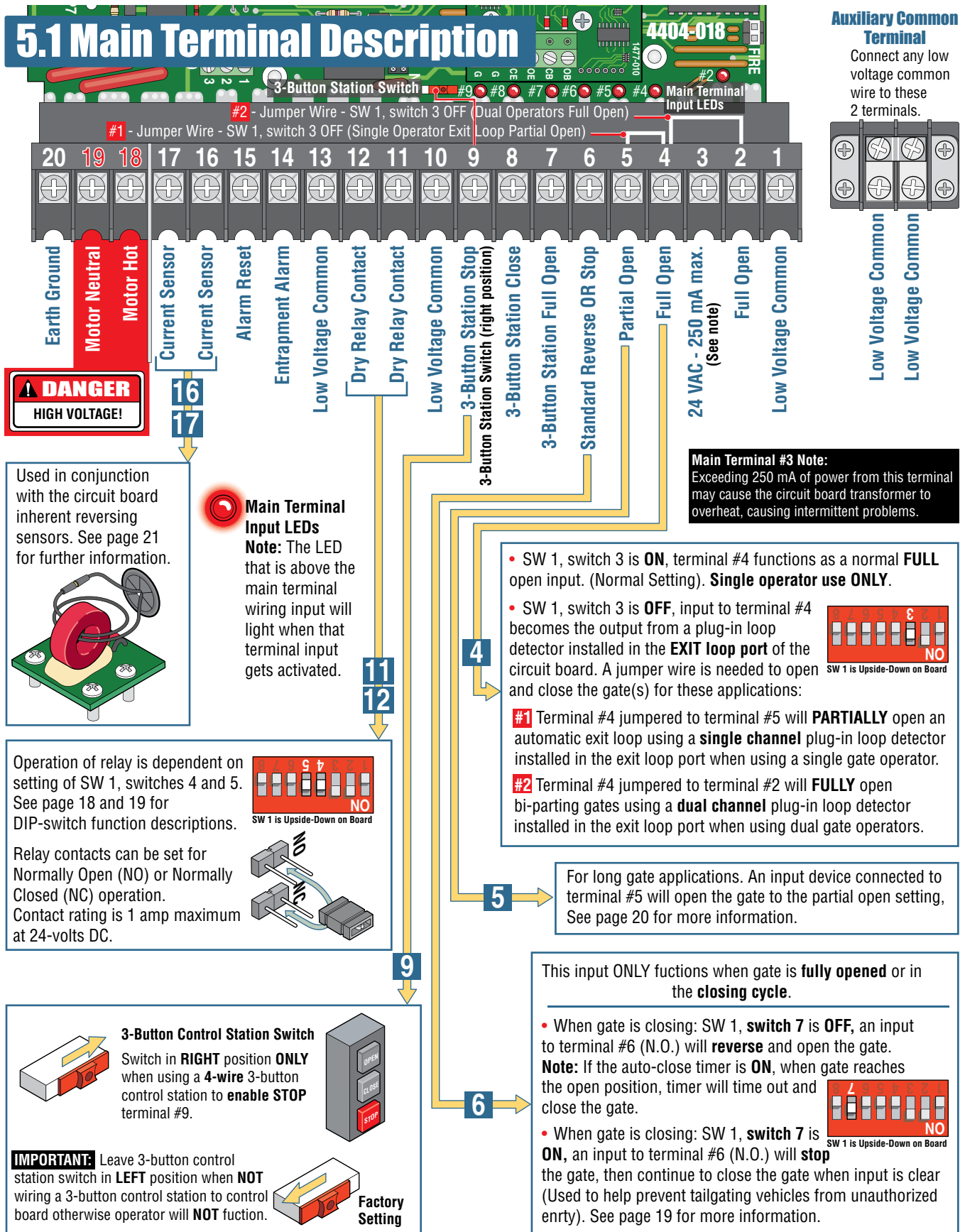

5.2 Control Wiring for Single/Primary Operator

Important: Controls intended for user activation must be located at least six (6) feet away from any moving part of the gate and where the user is prevented from reaching over, under, around or through the gate to operate the controls.

Emergency access controls only accessible by authorized personnel (e.g., fire, police, EMS) may be placed at any location in the line-of-sight of the gate.

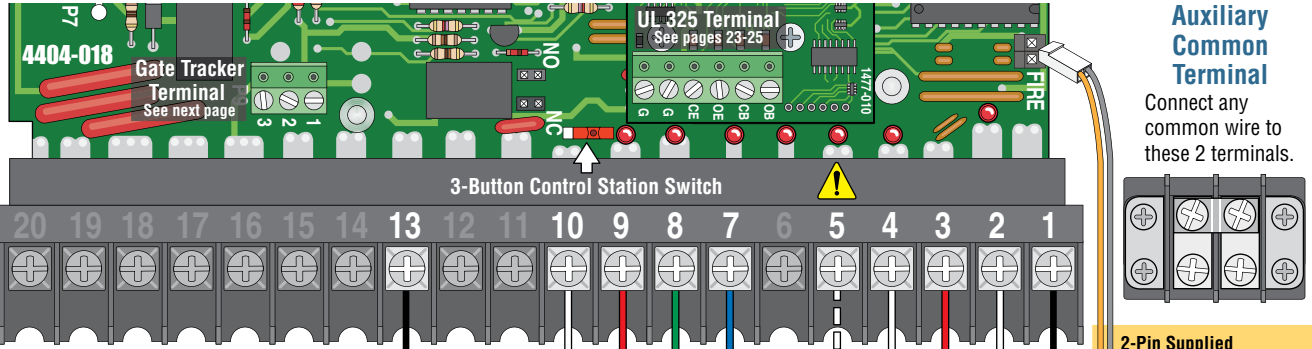

Auxiliary Common Terminal
Connect any common wire to these 2 terminals.

Note: All stand-alone and telephone entry devices must use a separate power source.

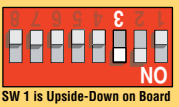

SW 1, Switch 3 MUST be ON except for dual operators or exit loop partial open applications.

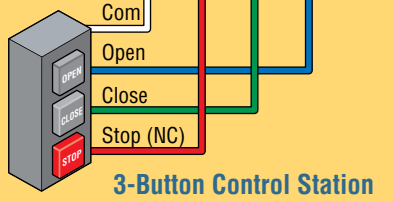
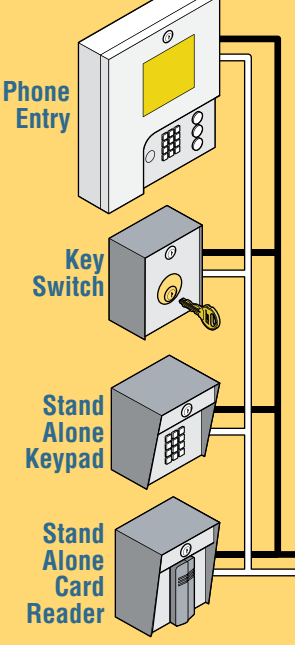

3-Button Control Station Switch
Switch in **RIGHT** position **ONLY** when using a 4-wire 3-button control station with a normally closed **STOP** circuit.

IMPORTANT: Leave 3-button control station switch in **LEFT** position when **NOT** wiring a 3-button control station to control board otherwise operator will **NOT** function.

Factory Setting



#5 Terminal Note: Any opening device connected to terminal #5 will open the gate to the partial open setting. External entrapment protection devices will also open the gate to the partial open setting. If the **Inherent Reverse Sensor** gets activated during the close cycle, it will always **fully** open the gate.

Gate will **ONLY OPEN** when this device is activated by authorized personnel **ONLY** (fire, police, EMS) and operator has power. Alarm will sound during entire open cycle. Operator will then go into a hard shutdown once fully opened. Operator **MUST** be reset to function normally again. This device **MUST** be mounted in the line-of-site of gate so authorized personnel can monitor gate movement.

Activation Note: Activation of this device will **OPEN** gate regardless of the status of the open direction monitored external entrapment protection device(s). If gate is opening, and the operator's **inherent** entrapment protection system detects an obstruction, the operator will reverse approx. 2 inches and go into a hard shutdown. Operator reset button **MUST** be pushed to function again **OR** cycle operator's power.

3-Wire Radio Receiver

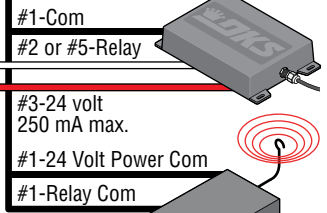

4-Wire Radio Receiver

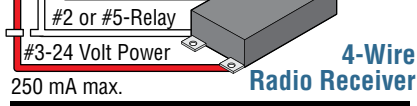

Main Terminal #3 Note:
Exceeding 250 mA of power from this terminal may cause the circuit board transformer to overheat, causing intermittent problems.

Type of wiring to be used on ALL external devices:
A) Type CL2, CL2P, CL2R, or CL2X.
B) Other cable with **equivalent** or **better** electrical, mechanical, and flammability ratings.

5.3 Auxiliary Device Wiring

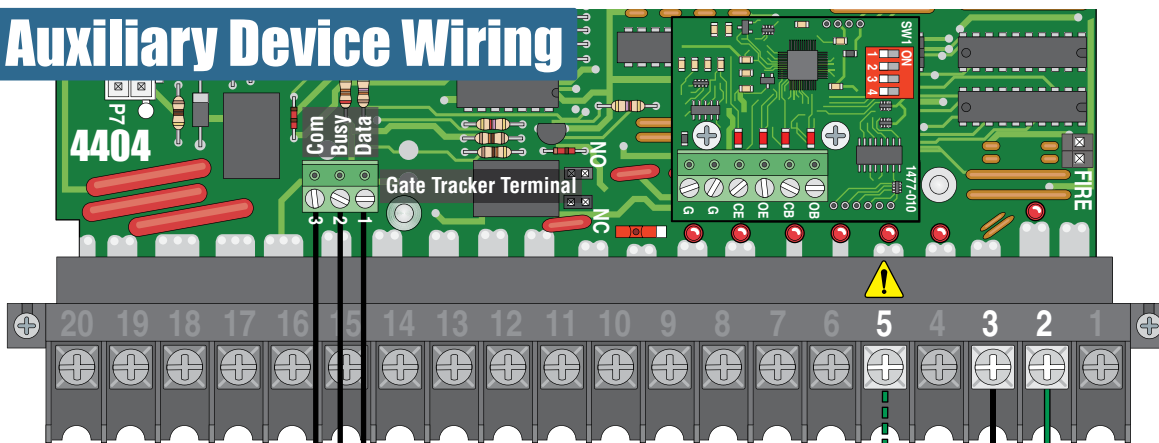

Type of wiring to be used on ALL external devices:

A) Type CL2, CL2P, CL2R, or CL2X.

B) Other cable with equivalent or better electrical, mechanical, and flammability ratings.

Gate Tracker - DoorKing Access Control System (Model 1833, 1835, 1837 or 1838) tracker system can be connected. This system can keep track of gate operator cycle count, shorted inputs, loop detector problems, any forced entry attempts, if the gate has struck anything during the open or close cycle, power interruptions, etc. For more detailed information refer to the Tracker Installation and Wiring Manual, DoorKing P/N 2358-065.

Terminal #2 (Full open) or #5 ⚠️ (Partial open) required only if the tracker board will activate the gate operator. Refer to the manual 2358-065 for detailed information.

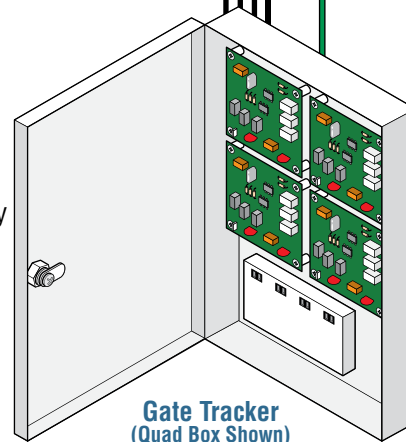

SECTION 6 - OPERATING INSTRUCTIONS

IMPORTANT SAFETY INSTRUCTIONS

This vehicular gate operator is designed for Class III and Class IV applications only. All users of this gate operating system **MUST** be trained on the proper and safe operation of the system and must be made aware of all hazards that may be associated with the system.

WARNING - To reduce the risk of injury or death:

1. READ AND FOLLOW ALL INSTRUCTIONS.
2. Never let children operate or play with gate controls. Keep the remote control away from children.
3. Always keep people and objects away from gate. **NO ONE SHOULD CROSS THE PATH OF THE MOVING GATE.**
4. Test the operator monthly. The gate **MUST** reverse on contact with a rigid object or stop or reverse when an object activates the non-contact sensors. After adjusting the force or the limit of travel, retest the gate operator. Failure to adjust and retest the gate operator properly can increase the risk of injury or death.
5. Use the emergency release only when the gate is not moving and power has been shut-off.
6. **KEEP GATES PROPERLY MAINTAINED.** Read the owner's manual. Have a qualified service person make repairs to gate hardware.
7. The entrance is for vehicles only. Pedestrians must use separate entrance.
8. **SAVE THESE INSTRUCTIONS.**

6.1 AC Power Switch and Reset Button

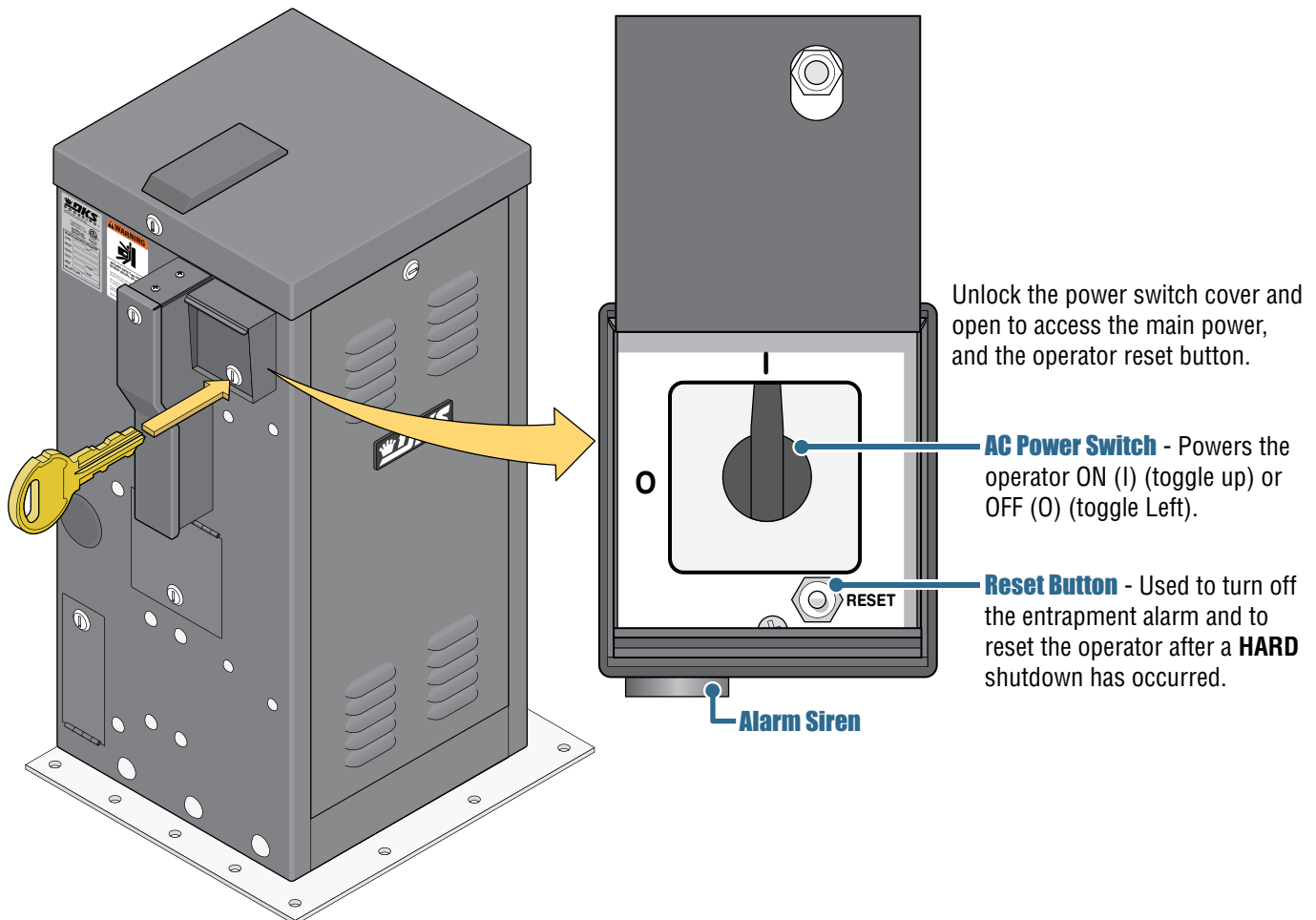

6.2 Shutdown Conditions

Under various entrapment conditions the operator will assume either a **soft** or **hard (alarm)** shutdown. To determine what type of reset action is required, you will need to understand how the different entrapment conditions affect the gate operator.

Soft Shutdown

This occurs in various situations where the inherent or external entrapment protection devices have been activated. In a soft shutdown condition, the operator **will not** respond to any input that was present when the entrapment protection device sensed an obstruction. If the gate stops at the open position, the operator will not respond to the automatic close timer.

- **Example 1** - A time clock keys the gate open in the morning and an entrapment protection device senses an obstruction prior to the gate reaching the full open position. If the entrapment is sensed by the inherent system, the gate will reverse and run back to the closed position. The time clock input is still present, but the gate will not re-open.

Note: In some systems, the time clock input comes from the telephone entry system relay. This same relay may also provide open commands for a card reader, MicroPLUS transmitters and the visitor telephone entry. If so, these devices will also be disabled in a soft shutdown condition.

- **Example 2** - If the gate is closing and an entrapment protection device is activated, the gate will either stop or reverse and run back to the open position, depending upon if the external or inherent device was activated. The automatic close timer will not close the gate.
- **Example 3** - Vehicle arrives at exit loop and gate runs towards the open position. If the inherent entrapment protection gets activated during this opening cycle, the gate reverses and runs back to the closed position. After the inherent entrapment protection is cleared, if the vehicle is still present at the exit loop, a soft shutdown condition does not occur. The exit loop input provides an immediate reset of the operator and the gate will again run to the open position.

Resetting a Soft Shutdown

In some conditions, a soft shutdown will reset as soon as the entrapment condition clears. For example, if a non-contact sensor (photo cell) is sensing an obstruction, the operator will stop the gate and assume a soft shutdown condition. When the photocell clears, the operator will return to normal operation.

When the operator is in a soft shutdown, activation of any “intended input” will reset the operator. An “intended input” includes any command, any standard safety input and any loop input. Activating any of these inputs will reset the gate. At that point the gate will return to normal operation. If the gate is open, the automatic close timer will then time out and close the gate.

Hard Shutdown (Alarm Activated)

A hard shutdown condition occurs when: (1.) The inherent entrapment protection system (Type A) gets activated TWO consecutive times before the gate completes the open or close cycle. (2.) The reversing edge (Type B2) gets activated and reverses but before the gate completes the reverse cycle the inherent entrapment protection system (Type A) gets activated.

- **Example of a Hard Shutdown** - The gate is closing and the inherent entrapment protection system senses an obstruction and causes the gate to reverse direction. As the gate begins to run in the open direction, a second obstruction is sensed prior to the gate reaching the full open position. Once the second obstruction has been sensed, the operator will stop, **the audio alarm will sound and all standard inputs are shut down** (including open commands, safety commands, loop inputs, etc.).
 - **To silence the alarm**, press the reset button or after 5 minutes, the audio alarm will shut off but will “chirp” every 5 seconds. This indicates that the operator is in a hard shutdown condition (The reset button must be pressed to reset the operator and stop the alarm “chirping”).

Resetting a Hard Shutdown

The operator is in a hard shutdown condition when the audio alarm is sounding OR “chirping” every 5 seconds.

- Before resetting a hard shutdown, determine why the shutdown occurred. Inspect the gate for any obstructions along its path that could have activated the inherent entrapment sensing system. Inspect the gate and gate hardware.

The audio alarm will sound for five minutes, or until the operator’s reset button is pushed. After (5) five minutes the alarm will “chirp every 5 sec.” and the hard shutdown condition will remain in affect until the reset button is pushed.

Once the operator has been reset, an open or close command is needed to start the gate operator. Most activating commands will cause the gate operator to cycle to the open position. This includes activation of a key switch or open command and activation of an automatic exit loop. Activation of a close command will run the gate to the closed position.

Note: DoorKing operators have a built-in alarm reset push button mounted on the operator (See previous page for reset button location). Activating this button will return the gate operator to normal operation, but will not cycle the gate operator.

6.3 Manual Gate Operation

Unlock Manual Crank Access Panel

Cuts off AC power to the operator.

Manual Crank

Insert the supplied manual hand crank into the access hole until it engages with the motor shaft.
Turn the crank to open the gate.

Caution: NEVER attempt to manually operate any gate until you have verified that power to the operator has been shut-off.

Manually Move Gate

When there is **NO** power to gate operator, gate can be manually pushed open (Fail-Safe).

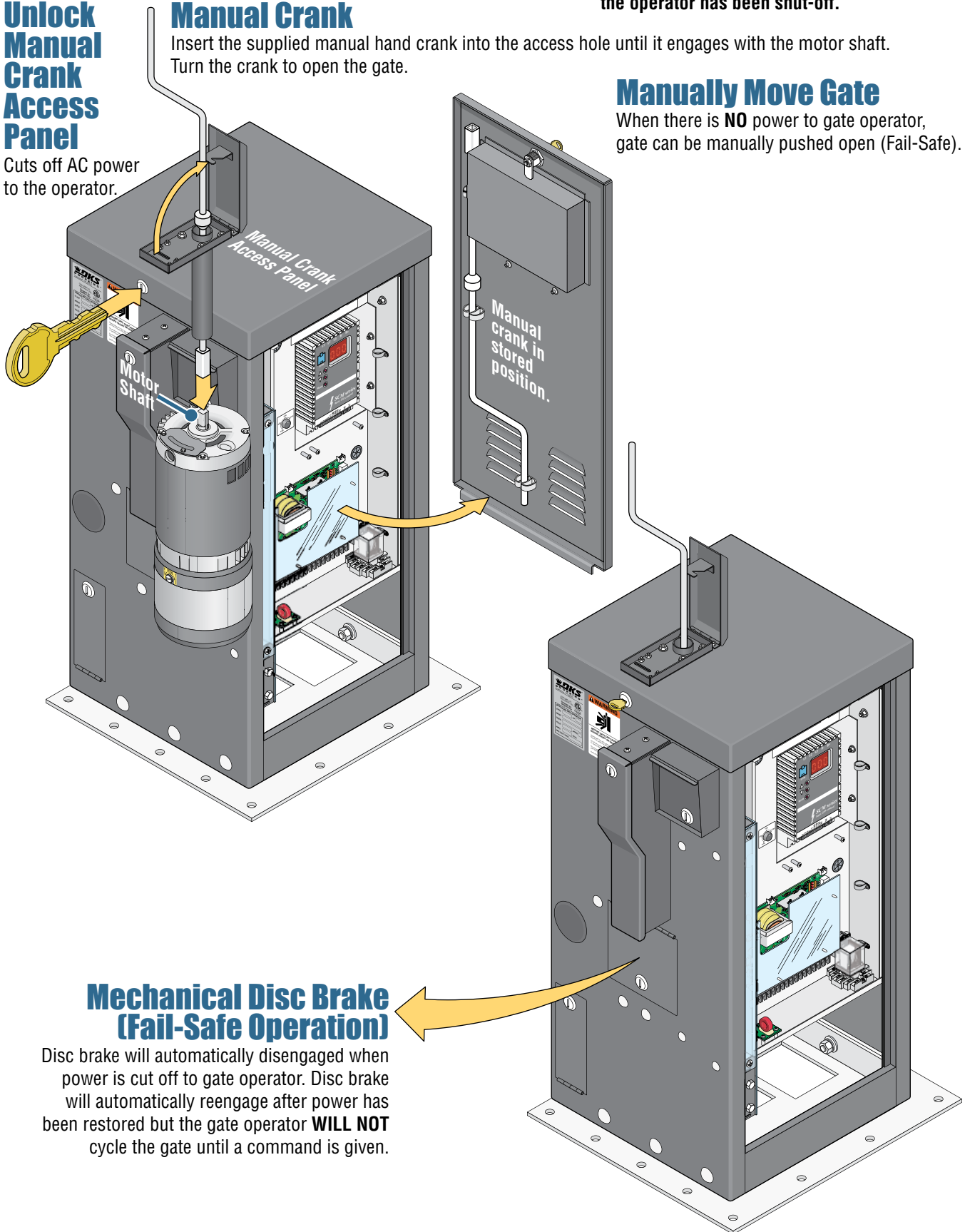

SECTION 7 - MAINTENANCE AND TROUBLESHOOTING

Inspection and service of this gate operator by a qualified technician should be performed anytime a malfunction is observed or suspected. High cycle usage may require more frequent service checks.

7.1 Maintenance

When servicing the gate operator, always check any external reversing devices (loops, photocells, etc.) for proper operation. If external reversing devices cannot be made operable, do not place this operator in service until the malfunction can be identified and corrected.

Always check the inherent reversing system when performing any maintenance. If the inherent reversing system cannot be made operable, remove this operator from service until the cause of the malfunction is identified and corrected. Keeping this operator in service when the inherent reversing system is malfunctioning creates a hazard for persons which can result in severe injury or death should they become entrapped in the gate.

When servicing this gate operator, always turn power **OFF!!**

To disconnect **battery power** from solenoid, remove battery module. See page 16.

If gearbox requires oil, use only Mobil SHC-629 Synthetic Gear Oil. Do not completely fill gearbox with oil. Gearbox should be half full only. Do not exceed this level.

Operator Component	Maintenance	Monthly Interval		
		1	6	12
Warning Signs	Check that warning signs are on BOTH sides of the gate area.	✓		
Alarm	Activate the primary (inherent) reverse system by blocking the gate with a solid object. When the gate reverses, block the gate in the opposite direction prior to the limit being reached. The entrapment alarm should activate. Press the reset button to silence the alarm.	✓		
Solenoid Mechanical Brake	Turn AC power OFF to operator. Solenoid should automatically disengage mechanical brake. When AC power is turned back ON, solenoid should automatically reengage mechanical brake.	✓		
Battery	Check the battery for any leakage or loose connections. Battery should be replaced every two years.	✓		
Chain	Check for sagging. Tighten if necessary.		✓	
Fire Dept.	Check emergency vehicle access device for proper operation.	✓		
Gate	Inspect for damage. Check gate wheels, rollers and guides for wear and grease if necessary.		✓	
Grease	Wheels and guide rollers if necessary.		✓	
Loop(s)	Check vehicular exit and reverse loops for proper operation.	✓		
Primary Reverse System	Check that the gate reverses on contact with an object in both the opening and closing cycles. See page 40. Adjust the reversing sensor if necessary.	✓		
Manual Release	Check manual release for proper operation. See page 39.	✓		
External Reverse Devices	Check external reverse devices stop or reverse the gate when activated. See page 40.	✓		
Sprockets	Check set screws for tightness.		✓	
Complete System	Complete check of gate and gate operating system.			✓

7.2 Built-In Diagnostic Tests

This gate operator is designed with built-in diagnostics that will alert you to potential or existing problems that the microprocessor has detected. Specific fault conditions are checked and the operator will signal that a fault exist through the built-in alarm.

Constant alarm is heard when power is applied: This indicates that the limit switch wire harness is not connected to the circuit board. In this condition, the operator will not run and the tone will continue until the fault is corrected. Check to be sure that the limit switch plug is properly inserted into the limit switch plug on the circuit board.

Constant alarm is heard: This indicates that the operator is in a hard shutdown condition (section 6.2 on page 31). The tone will continue to sound for five minutes, and then will beep once every five seconds. The operator-reset button must be pressed or power must be removed and then reapplied to return the operator to normal operation.

Short “chirp” is heard every five seconds: This indicates that the operator has been in a hard shutdown condition in excess of five minutes. This will continue until the operator-reset button is pressed or until power is removed from the operator (section 6.2 on page 31).

Operator runs for 1 second and stops, two short “chirps” are heard: This indicates that there may be a fault with the current sensor circuit.

7.3 Troubleshooting

Have a good VOM meter to check voltages and continuity. A Meg-Ohm meter capable of checking up to 500 meg-ohms of resistance is necessary to properly check the integrity of the ground loops. When a malfunction occurs, isolate the problem to one of three areas: **1.** the operator, **2.** the loop system, **3.** the keying devices. **Use caution when checking high voltage terminals, motor capacitor and the motor.**

- 1.** Check the input indicator LEDs. They should only come ON when a keying device (card reader, push button, etc.) is activated. If any of the input LEDs are ON continuously, this will cause the gate operator to hold open. Disconnect the keying devices one at a time until the LED goes OFF.
- 2.** Check any external entrapment protection devices. Any short or malfunction in these devices can cause the gate operator to stop or to hold open.
- 3.** A malfunction in a loop or loop detector can cause the gate operator to hold open, or to not detect a vehicle when it is present over the loop. Pull the loop detector circuit boards from the loop ports on the operator circuit board. If the malfunction persists, the problem is not with the loop system. For more information on trouble shooting loops and loop detectors, refer to your loop detector instruction sheet and to the DoorKing Loop and Loop Detector Information Manual located on DoorKing's web site.
- 4.** Check to be sure that there are no shorted or open control wires from the keying devices to the gate operator. If a keying device fails to open the gate, press the Key Switch or momentarily jumper across terminals 1 and 4 on the operator circuit board. If the gate operator starts, this indicates that a problem exist with the keying device and is not with the gate operator.
- 5.** If a three-button control station (open-close-stop) is connected to this gate operator, check for proper wiring. Only a DoorKing three button control station (P/N 1200-006 or 007) can be used with this gate operator. Others will cause a malfunction.
- 6.** Check the high voltage supply. A voltage drop on the supply line (usually caused by using too small supply voltage wires) will cause the operator to malfunction. Refer to the wire size chart in section 2.1 on page 15.

Symptom	Possible Solution(s)
Operator will not run. Power LED is OFF.	<ul style="list-style-type: none"> • Check that AC power to the operator is turned ON. • Transformer may be overheated. Turn power off and allow board to cool for several minutes then retest. Check for low VAC power and low voltage shorts. • Check for VAC at high voltage input terminal. If voltage measures 0, check the incoming power wires or replace circuit board.
Operator will not run, entrapment protection input(s) LED is ON.	<ul style="list-style-type: none"> • The entrapment protection device has a fault or the wiring to it is shorted.
Operator will not run, entrapment protection input(s) LED is Blinking.	<ul style="list-style-type: none"> • The entrapment protection device is not connected or the wiring to it is open.
Gate opens a short distance, then stops and reverses.	<ul style="list-style-type: none"> • Disconnect the gate from the gate operator and check that the gate slides freely without any binding. • Re-adjust the reverse sensitivity. • Continue troubleshooting.
Gate opens but will not close.	<ul style="list-style-type: none"> • Check the input LEDs. Any ON will hold the gate open and indicates a problem with a keying device. • Check the external safety devices. Any activated will hold the gate open and indicates a problem with the safety device. • Check the loop detectors. Any activated can hold the gate open and indicates a problem with loop detector or ground loop. • Operator may be in a "soft shutdown." Activate any keying device to determine if operator returns to normal operation. • If automatic close is desired, be sure SW 1, switch 2 is ON and set timer open from 1-23 seconds. • Bypass circuit board and check motor as above.
Gate closes but will not open.	<ul style="list-style-type: none"> • Operator may be in a "soft shutdown." Check input LEDs. If any are ON, momentarily disconnect, then re-connect the wire going to the respective terminal. Operator should open. • Check to be sure that the operator is running in the proper direction. Turn power OFF, and then back ON. Activate a keying device. Operator should run in the open direction. If operator runs in the close direction, turn power OFF and change direction switch SW 1, switch 1. Go to above section if operator now opens but will not close. • Be sure that the each LED on the control board lights when the keying device connected to the that terminal is activated. If LED does not light, momentarily place a jumper wire from terminal 1 to the input terminal being checked. If LED lights and gate opens, problem is with the keying device. If LED does not light, replace control board. • Bypass circuit board and check motor as described above.
Gate starts to close, then reverses to open.	<ul style="list-style-type: none"> • Re-adjust the reverse sensitivity. • Disconnect the gate from the gate operator and check that the gate slides freely without any binding. • Check the loop detector LEDs and input LEDs. Any that flash ON will cause the gate to reverse. • Continue troubleshooting.
Gate closes then re-opens.	<ul style="list-style-type: none"> • Check for any input or loop detector LED's that are ON. • Check that the operator is running in the proper direction (see "gate closes but will not open").
Alarm is sounding. Operator will not run.	<ul style="list-style-type: none"> • Operator is in a "hard shutdown" condition. Reset button must be pushed to return operator to normal operation, see Section 6.2 Shutdown Conditions, page 31. • Check the gate and gate hardware for any binding, correct where necessary. • Gate may be too heavy.
Alarm chirps once every 5 seconds. Operator will not run.	<ul style="list-style-type: none"> • Operator has been in a "hard shutdown" condition in excess of 5 minutes. Reset button must be pushed to return operator to normal operation, see Section 6.2 Shutdown Conditions, page 31.
Alarm sounds when power is applied and operator will not run.	<ul style="list-style-type: none"> • The limit switch wire harness is not plugged into the circuit board. Check that the limit switch connector is properly plugged into the limit switch plug on the circuit board.
Operator runs for 1 second and stops, two short chirps are heard.	<ul style="list-style-type: none"> • There may be a problem with the current sensor on the circuit board. Replace the circuit board.
Operator has intermittent functionality problems that vary.	<ul style="list-style-type: none"> • The main terminal #3 250 mA power has been exceeded. Check total amp draw of connected device(s).

7.4 Accessory Items

UL 325 Monitored Entrapment Protection Devices available for the 9245 slide gate operators.

Type B2 Contact Sensors (Reversing Edge)

DoorKing 8080 Series Sensing Edges
Miller Edge Sensing Edges - all models with a T2 (resistive) termination.
Miller Edge wireless monitored transmitter/receiver kit model RB-G-K10
ASO GMBH Sentir GF Series sensing edges

Type B1 Non-contact Sensors (Photo Cell)

DoorKing Model 8080-057 Retro-Reflective Photocell
Miller Edge Reflective-Guard Model RG
Miller Edge Prime-Guard Model PG
EMX Industries Model IRB-MON
EMX Industries Model IRB-RET
Omron Model E3K-R10K4
Seco-Larm Model E-936-S45RRGQ
Seco-Larm Model E-960-D90GQ

Monitored Expansion Kit

Miller Edge Multi-Input Module Model MIM-62

Accessory items available for the 9245 slide gate operators.

Plug-In Loop Detector - Detectors plug directly into ports on circuit board simplifying wiring.

Single channel detector - P/N 9410-010
Dual channel detector - P/N 9409-010
Single channel detector with aux relay - P/N 9411-010
Single channel low power draw detector - P/N 9416-010
Dual channel low power draw detector - P/N 9415-010

External Loop Detector

Reno A&E 12/24 VDC or 24 VAC - 9402-045
Reno A&E 120 VAC - 9402-047
Carlo Gavazzi 24 VAC/VDC - 9402-044
Diablo 10-30 VAC/VDC low power draw - 9402-050

Chain Tray Kit - 10 Ft. section. Sections connect together to fit any length gate. P/N 2601-270

Pedestal Mounting Stand - Heavy-duty pedestal mounting stand for the 9200 series operator. P/N 9200-135

Heater and Fan Kit - Recommended for cold weather climates.

P/N 1601-195: **115 VAC models** P/N 1601-197: **208/230 VAC models**

Loop Wire - 18 AWG loop wire with XLPE insulation is ideal for ground loops. Available in 500 and 1000 foot rolls. Red, blue or black insulation.

Pre-Fab Loops - Prefabricated ground loops. 24-foot circumference with 50-foot lead-in. Available in yellow, red or blue jackets. Not for use in asphalt roadways.

Loop Test Meter - Meg-ohm meter checks the integrity of ground loops. P/N 9401-045

Interconnection Cable - Interconnect wire cable contains all the necessary wires to interconnect primary / secondary operators.

Cable length: 30 ft. - P/N 2600-755 40 ft. - P/N 2600-756 50 ft. - P/N 2600-757

Time Clock - 7 day time clock can be used to automatically open gate at pre-set time and days. Compact clock fits inside the operator. 7 day clock - P/N 2600-791

V-Wheels - 4 inch and 6 inch. UHMW or Steel. Roller bearings or sleeve bearings. Single or tandem wheel configurations.

Surge Devices - High and low voltage surge suppressors help prevent circuit board failure caused by lightning strikes and power surges.

High Voltage - P/N 1879-010 Low Voltage - P/N 1878-010

Speed Bumps - Prefabricated six-foot speed bump reduces traffic speed through gate system. P/N 1610-150

Model 9245 3 HP 1-Phase 208 / 230 VAC

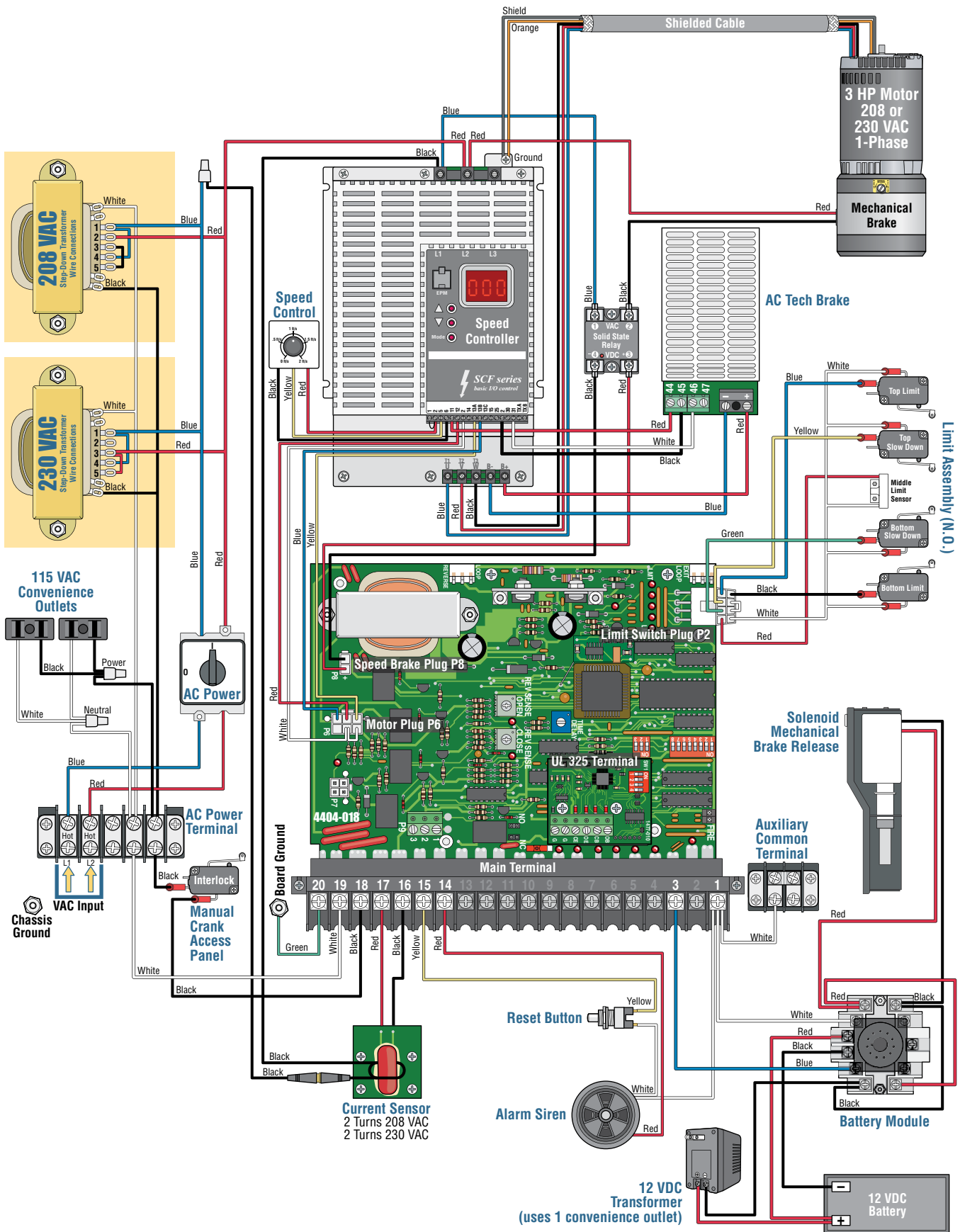

SECTION 8 - OWNER OF THE GATE OPERATOR

8.1 Alarm Sounding and Gate WILL NOT Operate



A KEY has been supplied that will unlock ALL the access panels and covers on this gate operator.

Note: The owner of the gate operator is responsible for the KEY availability.

 **When alarm is sounding . . . ALWAYS CHECK GATE AREA FOR ANY OBSTRUCTIONS FIRST.**

If the cause of the alarm cannot be corrected, shut-off power and **DO NOT** place this operator back into service until the malfunction can be identified and **CORRECTED**.

IMPORTANT: Putting this gate operator back into service without **CORRECTING** the cause of the alarm could result in severe injury or **DEATH!**

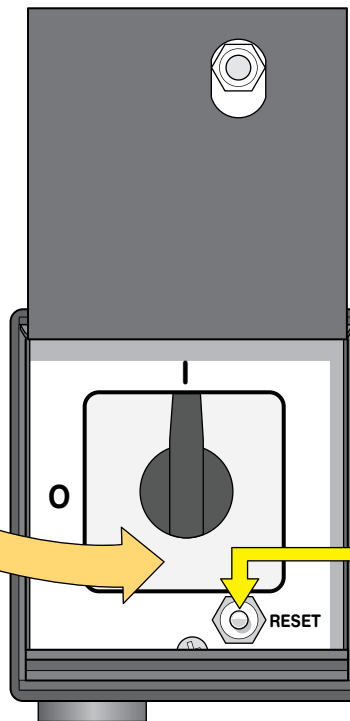
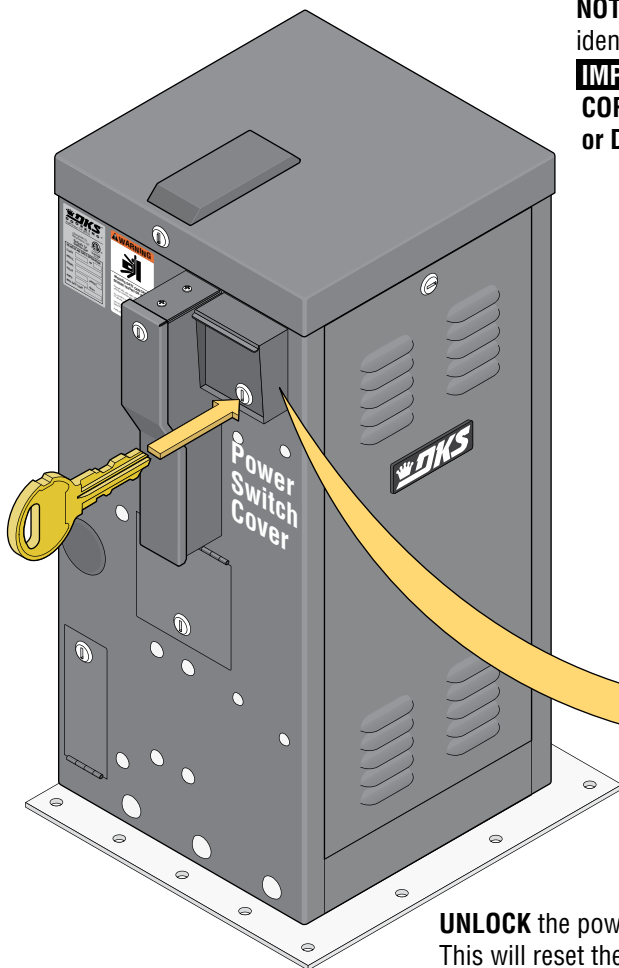

Note: Owner of the gate operator is responsible for safe gate operation and must be aware of all safety requirements in this manual.

UNLOCK the power switch cover with **KEY** and press **RESET BUTTON**. This will reset the gate operator and allow normal gate operation again.

Gate Operator is in a Hard Shutdown Condition when Alarm is Sounding

This occurs when:

1. The inherent entrapment protection system (Type A) gets activated **TWO** consecutive times before the gate completes the open or close cycle.
2. The reversing edge contact sensor (Type B2) gets activated and reverses but before the gate completes the reverse cycle the inherent entrapment protection system (Type A) gets activated.

The audio alarm will sound for five minutes, or until the operator's reset button is pushed. After (5) five minutes the alarm will "chirp every 5 sec." and the hard shutdown condition will remain in affect until the reset button is pushed.

Please read **SECTION 6 - OPERATING INSTRUCTIONS** for more information about operating this gate operator.

8.2 Manual Gate Operation

Caution: NEVER attempt to manually operate the gate until you have VERIFIED that power to the gate operator has been SHUT-OFF!

Please read SECTION 6 - OPERATING INSTRUCTIONS for more information about operating this gate operator.

Power Outage Manual Operation (FAIL-SAFE)

Gate can be IMMEDIATELY manually operated (pushed open) ONLY during a power outage. NO Key is required.

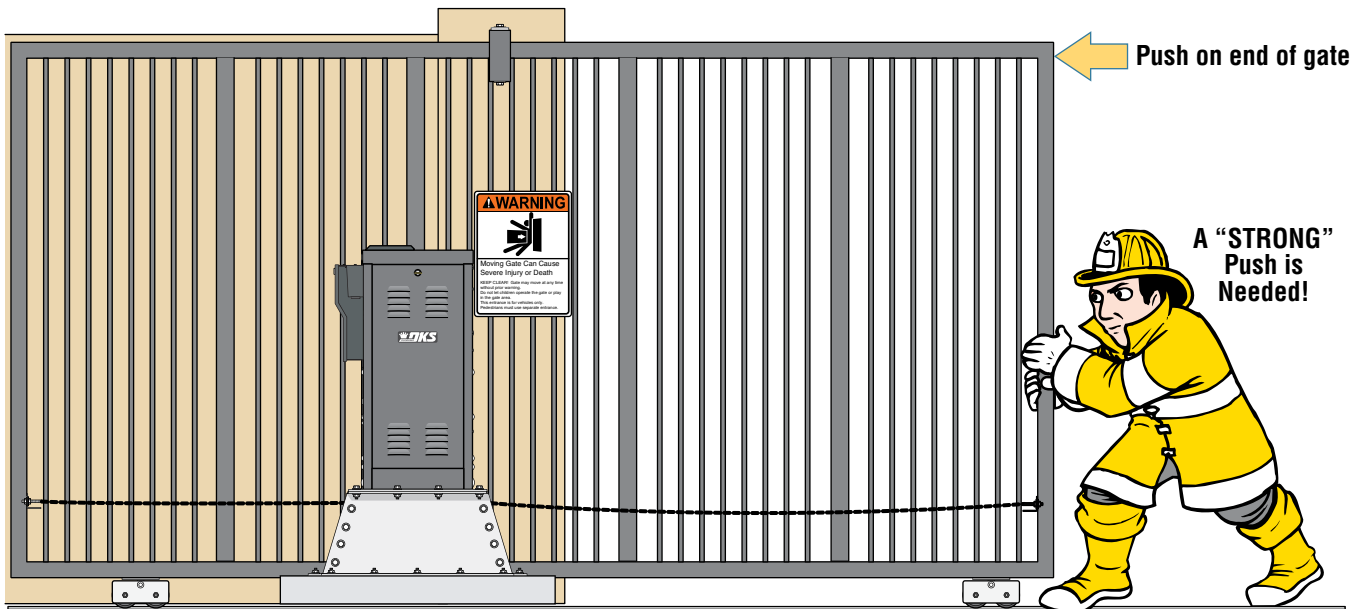

Manual Operation when Operator HAS Power

Note: Owner of the gate operator is responsible for safe gate operation and must be aware of all safety requirements in this manual.

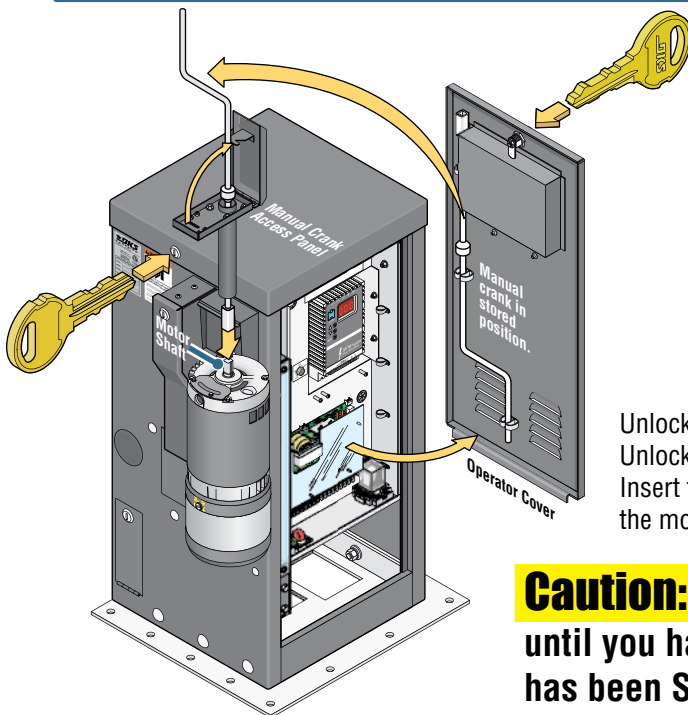

A KEY has been supplied that will unlock ALL the access panels and covers on this gate operator.

Note: The owner of the gate operator is responsible for the KEY availability.

Unlock manual crank access panel with KEY.
Unlock operator cover with KEY. Remove supplied manual crank.
Insert the manual crank into the access hole until it engages with the motor shaft. Turn the crank to open the gate.

Caution: NEVER attempt to manually operate the gate until you have VERIFIED that power to the gate operator has been SHUT-OFF!

8.3 Gate Operator's Monthly Checkup

Caution: Make SURE gate area is clear BEFORE testing the gate operator!

DO NOT repair or adjust gate systems yourself. Contact a trained gate systems technician with any questions or to make any repairs or adjustments. If you feel uncomfortable performing any of these inspections or testing, a qualified service technician will perform the visual inspections and testing for you. You can find a trained service technician at DoorKing's "Dealer Locator" at www.doorking.com

Visual Inspection

Visually inspect the rollers, fasteners, brackets and other gate hardware for proper alignment, proper tightness, and signs of damage, breakage, looseness, rust or wear. Moving parts should be lubricated and should not be squeaking. Visually inspect wiring for fraying or exposure. If a malfunction is found, contact a trained service technician to make adjustments or repairs.

Test Built-In Reversing Sensor

Begin with the gate in the fully **OPEN** position. Stand just outside the path of the gate and close the gate (typically auto-timer will time-out and close gate automatically). As the gate is **closing**, firmly press a solid object against the end of the gate frame in the direction opposing the travel of the gate. The gate should **stop** within 2 sec. and **reverse** to the **OPEN** position. Another input command is needed before the gate will reset and close again. Repeat this test while **opening** the gate. Start from the fully **CLOSED** position. While **opening**, gate should **stop** and **reverse** to the **CLOSE** position. If gate does **NOT** respond like it should in **either** direction of gate travel, contact a trained service technician to make adjustments or repairs.

Test Photo Sensors

If the gate has a photo sensing device protecting the path of a **closing gate**, perform the following test. Begin with the gate in the fully **OPEN** position. Stand just outside the path of the gate and close the gate (typically auto-timer will time-out and close gate automatically). Pass an object across the path of the closing photo sensing beam. The gate should **stop** within 2 sec. and **reverse** to the **OPEN** position. Typically the auto-timer times out and gate closes again.

If the gate has a photo sensing device protecting the path of a **opening gate**, start from the fully **CLOSED** position. **OPEN** gate. Pass an object across the path of the opening photo sensing beam. The gate should **stop**, the gate will resume opening when the beam is clear. If gate does **NOT** respond like it should in **either** direction of gate travel, contact a trained service technician to make adjustments or repairs.

Test Reversing Edges

If the gate has a reversing edge(s) protecting the path of a **closing gate**, perform the following test. Begin with the gate in the fully **OPEN** position. Stand just outside the path of the gate and close the gate. As the gate is closing, firmly press a solid object against the reversing edge in the direction opposing the travel of the gate. The gate should **stop** within 2 sec. and **reverse** to the **OPEN** position (typically auto-timer will time-out and close gate automatically). If the gate encounters **another** obstruction before it is closed, the gate will **stop** and reverse to the **OPEN** position **again**. A input command is needed before the gate will reset and close again, auto-timer will **NOT** close gate (Typically, press your remote button for input command). If the gate has a reversing edge(s) protecting the path of a **opening gate**, starting from the fully **CLOSED** position. Stand just outside the path of the gate and open the gate. **OPEN** gate. As the gate is opening, firmly press a solid object against the reversing edge in the direction opposing the travel of the gate. gate should **stop** and **reverse** to the **CLOSE** position. If gate does **NOT** respond like it should in **either** direction of gate travel, contact a trained service technician to make adjustments or repairs.

Note: This gate operator uses high levels of force to move the gate and most people underestimate the power of these systems and do not realize the potential hazards associated with this system if **NOT** maintained properly.

Scheduled maintenance visits are offered by most qualified service technicians to MAINTAIN your gate operator system.

Alarm Sounding and Gate Will NOT Operate

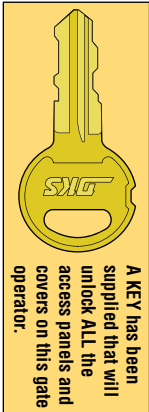

To obtain key to unlock gate operator contact:

Name _____

Phone # _____

When alarm is sounding . . . ALWAYS CHECK GATE AREA FOR ANY OBSTRUCTIONS FIRST

If the cause of the alarm cannot be corrected, shut-off power and DO NOT place this operator back into service until the malfunction can be identified and CORRECTED.

IMPORTANT! Putting this gate operator back into service without CORRECTING the cause of the alarm could result in severe injury or DEATH!

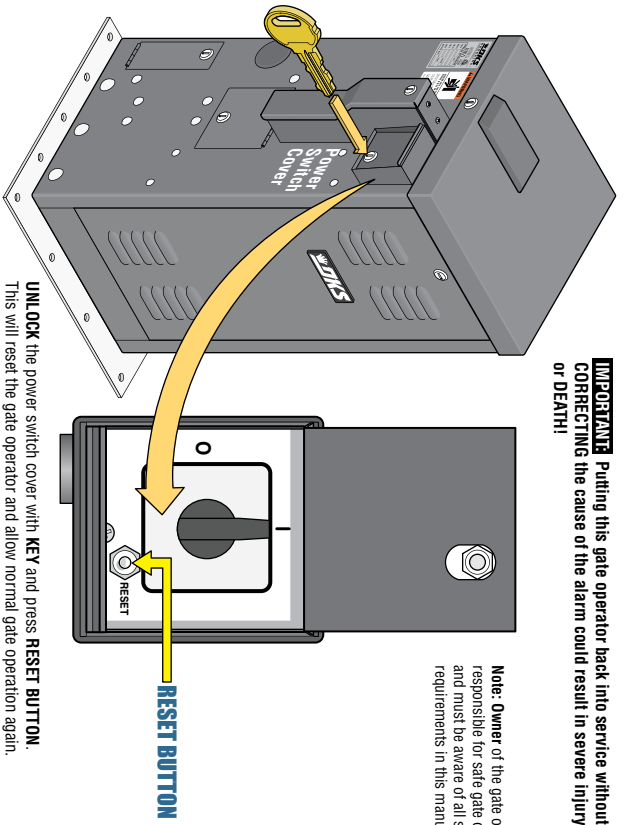

Note: Owner of the gate operator is responsible for safe gate operation and must be aware of all safety requirements in this manual.

Gate Operator is in a Hard Shutdown Condition when Alarm is Sounding

- This occurs when:
1. The inherent entrapment protection system (Type A) gets activated TWO consecutive times before the gate completes the open or close cycle.
 2. The reversing edge contact sensor (Type B2) gets activated and reverses but before the gate completes the reverse cycle the inherent entrapment protection system (Type A) gets activated.

The audio alarm will sound for five minutes, or until the operator's reset button is pushed. After (5) five minutes the alarm will "chirp every 5 sec.," and the hard shutdown condition will remain in effect until the reset button is pushed.

Please read SECTION 6 - OPERATING INSTRUCTIONS for more information about operating this gate operator.

www.doorking.com to get a PDF of this manual - Remove this page OR print this page in color, fold and laminate - Place at the gate operator

Manual Gate Operation

Caution: NEVER attempt to manually operate the gate until you have VERIFIED that power to the gate operator has been SHUT-OFF!

Power Outage Manual Operation (FAIL-SAFE)

Gate can be IMMEDIATELY manually operated (pushed open) ONLY during a power outage. NO Key is required.

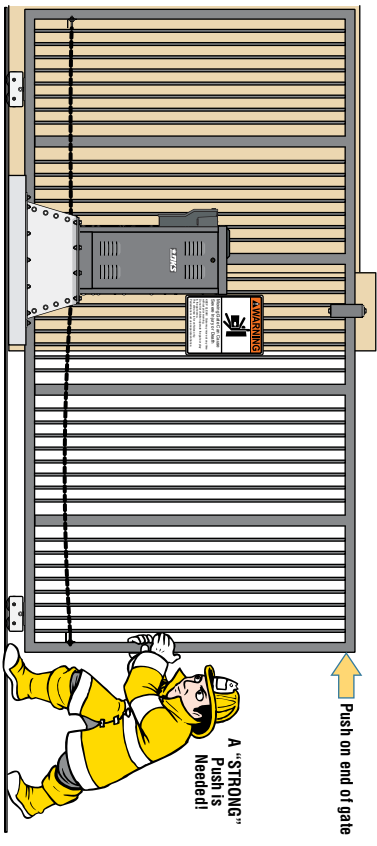

Manual Operation when Operator HAS Power

Gate CAN NOT be manually PUSHED open when operator HAS power. It MUST be manually cranked.

Note: Owner of the gate operator is responsible for safe gate operation and must be aware of all safety requirements in this manual.

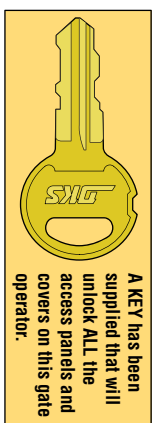

To obtain key to unlock gate operator contact:

Name _____

Phone # _____

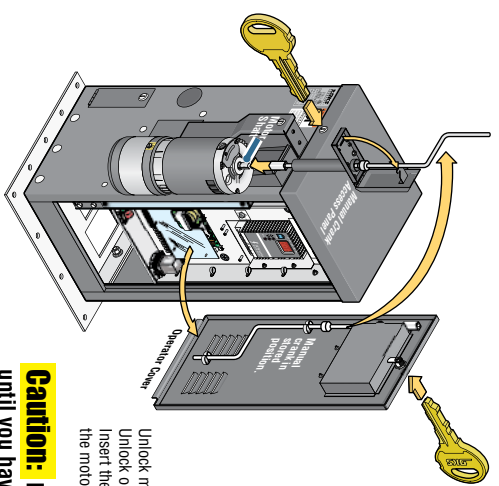

Unlock manual crank access panel with KEY. Insert the manual crank into the access hole until it engages with the motor shaft. Turn the crank to open the gate.

Caution: NEVER attempt to manually operate the gate until you have VERIFIED that power to the gate operator has been SHUT-OFF!

Place at the gate operator

Installation/Owner's Manual

9245

Heavy-Duty Vehicular Slide Gate Operator

Use this manual for circuit board 4404-018 Revision A or higher.

9245-065-T-9-24

Entrapment Protection must be provided for the gate system where the risk of entrapment or obstruction exists. The operator will NOT run without one or more monitored type B1 or B2 entrapment protection devices in EACH direction of gate travel.

UL 325 August 2018 Standard



This vehicular gate operator is designed for **Class III** and **Class IV** applications **ONLY** and must **NEVER** be used in applications serving the general public.

Owner of the gate operator is responsible for safe gate operation and must be aware of all safety requirements in this manual.

THIS PRODUCT IS TO BE INSTALLED AND SERVICED BY A TRAINED GATE/DOOR SYSTEMS TECHNICIAN ONLY.
Visit www.doorking.com/dealer-locator to find a professional installing and servicing dealer in your area.

www.doorking.com

DoorKing, Inc.
120 S. Glasgow Avenue
Inglewood, California 90301
U.S.A.

Phone: 310-645-0023
Fax: 310-641-1586