

# Installation/Owner's Manual

# Model 9024-381

Solar Powered Vehicular Slide Gate Operator

Use this manual for circuit board 4100-018 Revision A or higher.

9024-066-G-9-24

**UL 325 August 2018 Standard**

**Bi-Parting Gate Operators CANNOT be used with Solar Applications.**

Entrapment Protection must be provided for the gate system where the risk of entrapment or obstruction exists. The operator will NOT run without one or more monitored type B1 or B2 entrapment protection devices in EACH direction of gate travel.

## Solar Powered

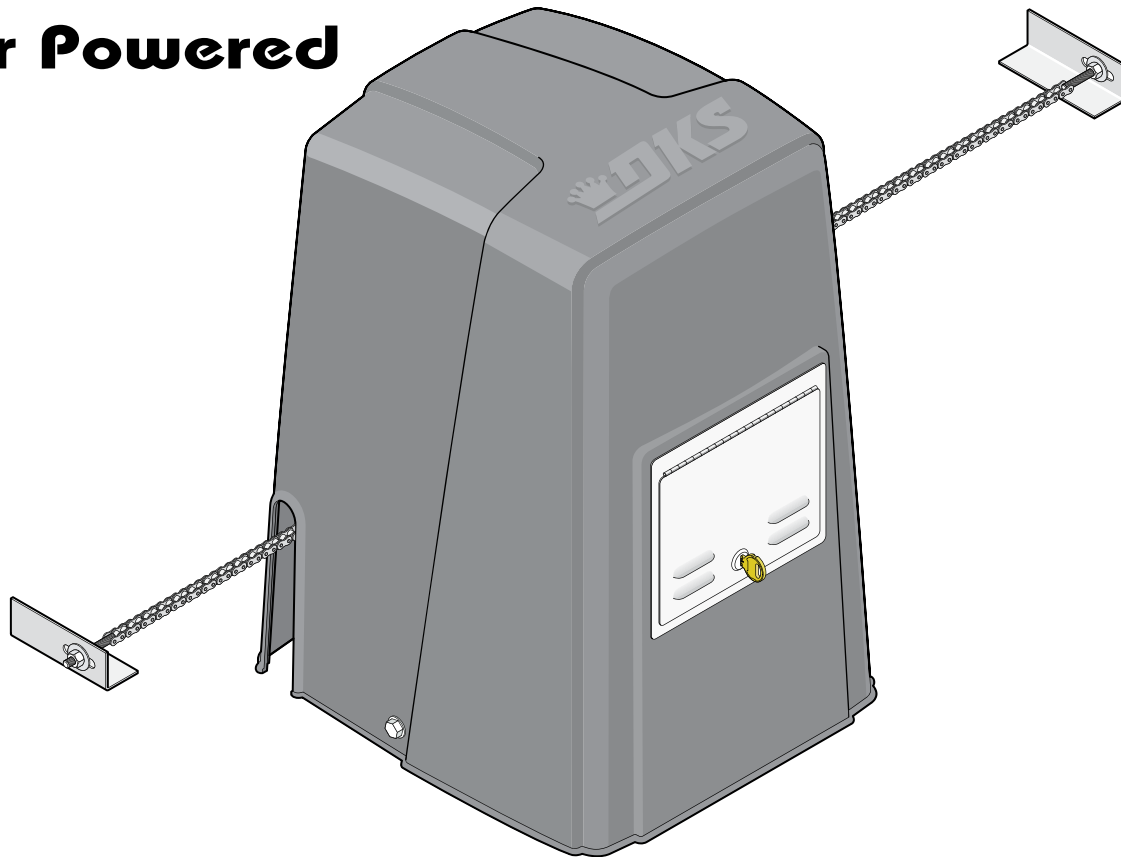

**THIS PRODUCT IS TO BE INSTALLED AND SERVICED BY A TRAINED GATE/DOOR SYSTEMS TECHNICIAN ONLY.**  
Visit [www.doorking.com/dealer-locator](http://www.doorking.com/dealer-locator) to find a professional installing and servicing dealer in your area.

## Solar Powered

**Installer: Leave manual with property owner.**

Date Installed: \_\_\_\_\_

Installer/Company Name: \_\_\_\_\_

\_\_\_\_\_

Phone Number: \_\_\_\_\_

Circuit Board  
Serial Number  
and Revision Letter: \_\_\_\_\_

**Property Owner: Checklist in back of manual to review and verify new installation with Installer.**

Copyright 2024 DoorKing®, Inc. All rights reserved.



Listed to ANSI/CAN/UL 325





# QUICK GUIDE: DIP-Switches

See page 23 for more information about DIP-switches.



Reset button on circuit board **MUST** be pressed before new DIP-switch settings will take affect.

SW 1 (Top 8 DIP Switches)			
Switch	Function	Setting	Description
1	Operator Opening Direction	Opening direction using <b>ON</b> setting.  	Opening direction using <b>OFF</b> setting. Changes direction operator will cycle open upon initial AC power up and open command.
2	Auto-Close Timer	OFF	Auto-close timer is <b>OFF</b> . Manual input required to close an open gate.
		<b>ON</b>	<b>Normal Setting.</b> Auto-close timer is <b>ON</b> . Adjustable from 1-23 seconds.
3	Not Used	<b>OFF</b>	Switch <b>MUST</b> be turned <b>OFF</b> for Solar.
4	Reverses Gate	<b>OFF</b>	<b>Normal Setting.</b> Input to main terminal 10 and reverse loop will <b>reverse</b> gate during <b>close</b> cycle.
	Stops Gate (Slide gates)	ON	Input to main terminal 10 and/or reverse loop will <b>stop</b> gate during <b>close</b> cycle – gate will <b>continue to close</b> after input to main terminal 10 and/or reverse loop are cleared (Helps prevent tailgating).
5	Quick-Close Timer Override (Slide gates)	<b>OFF</b>	<b>Normal Setting.</b> Quick close feature is <b>OFF</b> . Auto-Close timer functions normally.
		ON	Quick close feature is <b>ON</b> . Opening gate will stop and close as soon as all reversing inputs (Reverse loops, photo sensors) are cleared regardless of the distance the gate has opened. Any Auto-Close timer setting overrides to 1 sec.
6 and 7	Relay: Main Terminals 13 and 14	6-OFF 7-OFF	<b>Normal Setting.</b> Relay activates when gate is at open limit.
		6-OFF 7-ON	Relay activates when gate is not closed.
		6-ON 7-OFF	Relay activates when gate is opening and open.
		6-ON 7-ON	Relay activates during opening and closing cycle.
8	Accessory Power	<b>OFF</b>	24 VDC 500 mA <b>accessory power</b> for accessories connected to main terminal 12.
		ON	<b>DO NOT USE</b> for Solar.

 Setting **MUST** be used

SW 2 (Bottom 8 DIP Switches)			
Switch	Function	Setting	Description
1 and 2	Select Operator Type	<b>1-OFF 2-OFF</b>	<b>Slide Gate Operator</b>
		1-OFF 2-ON	<b>DO NOT USE</b> for the 9024. Swing Gate Operator
		1-ON 2-OFF	<b>DO NOT USE</b> for the 9024. Barrier Gate Operator
		1-ON 2-ON	<b>DO NOT USE</b> for the 9024. Overhead Gate Operator
3	Input Power Failure Mode	OFF	<b>DO NOT USE</b> for Solar.
		<b>ON</b>	Gate <b>operates normally</b> until batteries get low. Gate will <b>CLOSE and Shutdown operator</b> in close position until battery power reaches an operable level again.
4	Reverse/Shadow Input	<b>OFF</b>	Main terminal 10 is a REVERSE input.
		ON	<b>DO NOT USE</b> for the 9024. Main terminal 10 is a SHADOW loop (Swing gates ONLY)
5	Overlapping Dual Gates	<b>OFF</b>	Switch 5 <b>MUST</b> be turned <b>OFF</b> for the 9024.
		ON	<b>DO NOT USE</b> for the 9024. Overlapping gates <b>ARE</b> used (Dual swing gates ONLY). Secondary gate starts to open a few seconds before primary gate starts.
6	Circuit Board Power Management	OFF	<b>DO NOT USE</b> for Solar. For 115/230 VAC input power. Board has <b>Constant power</b> .
		<b>ON</b>	Used for <b>Solar</b> input power. Board <b>Minimizes power</b> when not in use. All terminals shut down power except <b>main terminals 1, 2 and 3</b> .
7 and 8	Not Used	<b>OFF</b>	Switches 7 and 8 <b>MUST</b> be turned <b>OFF</b> for the 9024.

See page 32 for terminal wiring.

# QUICK GUIDE: Terminal Descriptions

## UL 325 Terminal

UL 325  
See pages 26 - 28

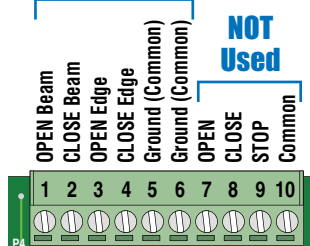

**NOT Used**

UL 325 LEDs  
See page 26

**Main Terminal Input LEDs Note:** The LED that is beside the main terminal wiring input will light when that terminal input gets activated.

Relay Contacts

4100-018

### Never Powers Down

- 1 Low Voltage Common
- 2 Full Open
- 3 24 VDC - 250 mA max. (See note below)
- 4 Not Used
- 5 Low Voltage Common
- 6 Not Used
- 7 Low Voltage Common
- 8 Not Used
- 9 Low Voltage Common
- 10 Reverse / Stop
- 11 Low Voltage Common
- 12 24VDC Accessories
- 13 Relay
- 14 Relay
- 15 Low Voltage Common
- 16 Not Used
- 17 Not Used
- 18 Low Voltage Common
- 19 Not Used
- 20 Not Used

Terminals 1, 2 and 3 are ALWAYS powered up, even after circuit board has powered down to manage the power drain on the batteries.  
**Opening devices MUST connect to terminal 2.**  
**IMPORTANT:** ANY access control device (radio receiver, key switch, exit loop or safety opening device) needs a relay contact time of **AT LEAST 1 SECOND** to bring the circuit board out of "idle time" and operate gate. See page 20.

This input **ONLY** functions when gate is **fully opened** or in the **closing cycle**.

- When gate is closing: SW 1, **switch 4 is OFF**, an input to main terminal 10 (eg: photo beam gets obstructed) will **reverse** and open the gate. **Note:** If the auto-close timer is ON, when gate reaches the open position, timer will time out and close the gate.
- When gate is closing: SW 1, **switch 4 is ON**, an input to main terminal 10 (eg: photo beam gets obstructed) will **stop** the gate, then continue to close the gate when input is clear (Used to help prevent tailgating vehicles from unauthorized entry). See page 23 for more information.

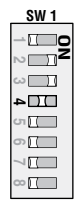

SW1, **switch 8 MUST be OFF:** 24-VDC 500 mA accessory power can be provided for desired accessories wired to terminal 12.  
**DO NOT** turn ON SW1, switch 8.  
**Note:** power to terminal 12 is **ONLY** available when the gate is opening, open, or closing. Power is OFF when the gate is closed.

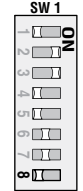
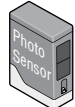

Operation of relay is dependent on setting of SW 1, **switches 6 and 7**. **Relay contacts** can be set for Normally Open (NO) or Normally Closed (NC) operation.  
Contact rating is 1 amp maximum at 24-volts DC.

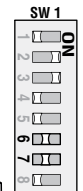
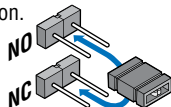

**Terminal #3 Note:** Exceeding 250 mA of power from this terminal may cause the circuit board transformer to overheat, causing intermittent problems.

## 20-Pin Main Terminal

# SPECIFICATIONS FOR MODEL 9024-381

Use this manual for the Model 9024-381 operator with circuit board 4100-018 Rev A or higher ONLY.

<b>Class of Operation</b>	UL 325 Class I, II, III, IV
<b>Type of Gate</b>	Vehicular Slide Gates Only
<b>Drive Sprocket Size</b>	#40 Chain
<b>Motor</b>	Quadra Drive DC Motor
<b>Power Input: Volts@Amps</b>	24 VDC @ 8 Amps
<b>Batteries</b>	None Included (24 VDC Output Required)
<b>Maximum Gate Cycles</b>	DKS Solar Power Kit: Solar Panel Power - Continuous DKS Solar Power Kit: ONLY Battery Power - 150+ Cycles Unknown when using Third Party Solar Power Setup

**Battery Power Note:** The number of gate cycles when using **ONLY** battery power **WILL** vary depending on gate weight, gate length, operating condition of gate hardware, temperature and amount of charge in batteries.

<b>Gate Speed</b>	1 Ft/Sec
<b>Max Gate Weight</b>	1,000 Lbs - 453.6 Kg (Gate installed level in good working condition)
<b>Max Gate Length</b>	40 Ft - 12.2 Meters (Gate installed level in good working condition)
<b>Inherent Entrapment Protection Device</b>	Inherent Reverse Sensor System (Type A)
<b>External Entrapment Protection Device Inputs (Monitored Inputs)</b>	Connection inputs for Non-contact Sensor - Photo Sensor (Type B1) Connection input for Contact Sensor - Reversing Edge (Type B2)

**Entrapment Protection must be provided for the gate system where the risk of entrapment or obstruction exists. The operator will NOT run without one or more monitored type B1 or B2 external entrapment protection devices in EACH direction of gate travel (minimum of 2 external devices required).**

Type of wiring to be used on ALL external devices:

A) Type CL2, CL2P, CL2R, or CL2X.

B) Other cable with equivalent or better electrical, mechanical, and flammability ratings.

## OPTIONAL DKS Solar Power Kit Recommended

Two 12 Volt 18 Amp/Hr Batteries

One 24 VDC Solar Panel

P/N 2000-070

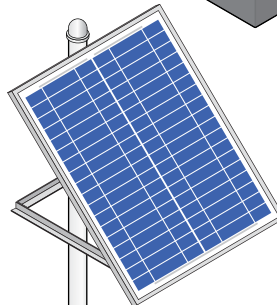
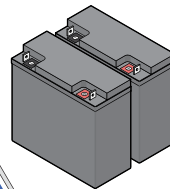

Mounting Post  
Not Included

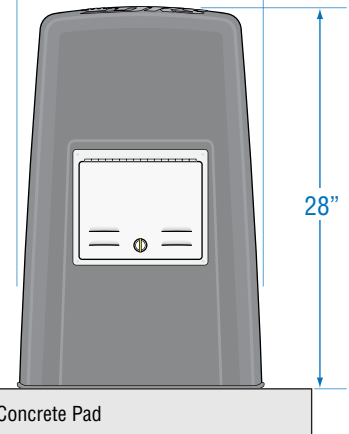
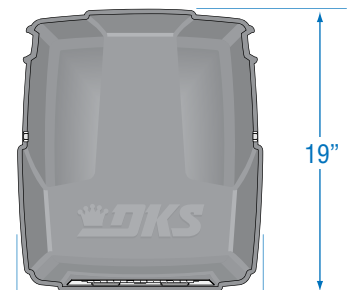
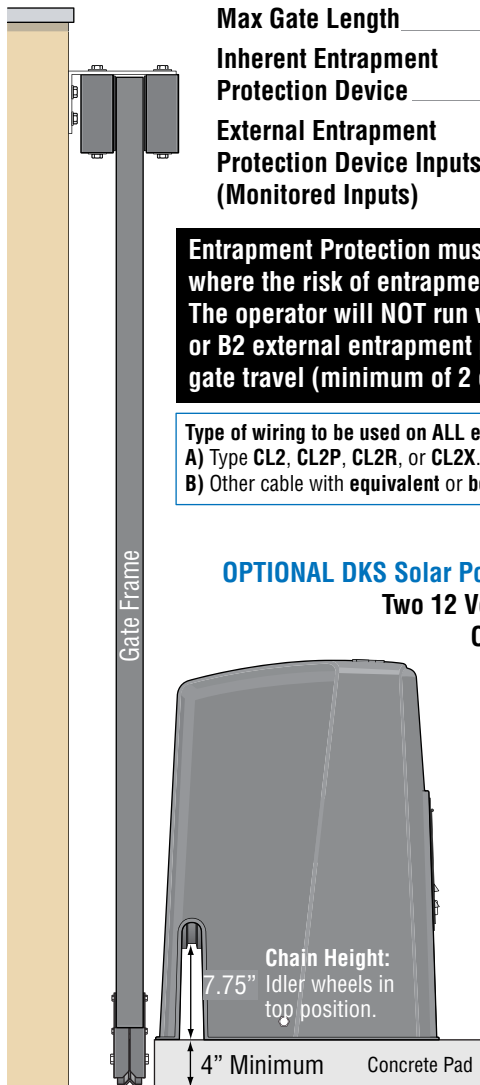

DoorKing, Inc. reserves the right to make changes in the products described in this manual without notice and without obligation of DoorKing, Inc. to notify any persons of any such revisions or changes. Additionally, DoorKing, Inc. makes no representations or warranties with respect to this manual. This manual is copyrighted, all rights reserved. No portion of this manual may be copied, reproduced, translated, or reduced to any electronic medium without prior written consent from DoorKing, Inc.

# TABLE OF CONTENTS

## QUICK GUIDES

Quick Guide: DIP-Switches	Quick Guide - 1
Quick Guide: Terminal Descriptions	Quick Guide - 2
Slide Gate Requirements	2
Safety Information for Slide Gate Operators	3
ASTM 2200 Standard for Gate Construction	4
Important Safety Instructions	4
Instructions regarding intended installation	4
Important Notices	5
UL325 Entrapment Protection	6
Glossary	7

## SECTION 1 - INSTALLATION 8

1.1 Hardware for the Gate	8
1.2 Underground Conduit Requirements	8
1.3 Typical Gate Types	9
1.4 Concerns BEFORE Solar Panel Installation	10
1.5 Solar Panel Positioning	11
1.6 Operator Mounting Positions	12-14
1.7 Concrete Pad Setup or Optional Post Mount Kit	15
1.8 Positioning Operator and Chain	16
1.9 Attaching Operator and Chain	16
1.10 Endless Idler Assembly (On Select Installations)	17
1.11 DoorKing's Chain Tray Kit	18
1.12 Installation of Warning Signs	18

## SECTION 2 - SOLAR INPUT POWER TO OPERATOR 19

2.1 Solar Power Connections	19
2.2 Power Select Jumper and Turning Power ON	20

## SECTION 3 - ADJUSTMENTS 21

3.1 4100 Circuit Board Descriptions and Adjustments	21
3.2 DIP-Switch Settings for 4100 Circuit Board	22-23
3.3 Limit Switches	24
3.4 Inherent Reverse Sensor Adjustment	25

## SECTION 4 - ENTRAPMENT AND SAFETY PROTECTION 26

4.1 UL 325 Description	26
4.2 External Entrapment Protection Device Locations	27-28
4.3 Plug-In Loop Detectors Wiring	29
4.4 External Loop Detectors Wiring	30

## SECTION 5 - MAIN TERMINAL WIRING 31

5.1 Terminal Descriptions	31
5.2 Control Wiring	32

## SECTION 6 - OPERATING INSTRUCTIONS 33

6.1 Operator Controls	33
6.2 Shutdown Conditions	34
6.3 Manual Gate Operation	35

## SECTION 7 - MAINTENANCE AND TROUBLESHOOTING 36

7.1 Maintenance	36
7.2 Built-In Diagnostics	36
7.3 Troubleshooting	37-38
7.4 Accessory Items	39
Model 9024-381 Solar Input Power Wiring Diagram	40

## SECTION 8 - OWNER OF THE GATE OPERATOR 41

8.1 Alarm Sounding OR "Chirping" and Gate WILL NOT Operate	41
8.2 Manual Gate Operation	42
8.3 Gate Operators Monthly Checkup	43
8.4 New Installation Checklist for Installer and Property Owner	44
Printable Safety Page	45

# Slide Gate Requirements

**This operator is intended for installation only on gates used for vehicles.** Pedestrians must be supplied with a separate access opening. For pedestrian access in the vicinity of an automated vehicular gate, separate pedestrian access shall be provided or available. The pedestrian access shall be in a location such that a pedestrian shall not come in contact with a moving vehicular gate access gate during the entire path of travel of the vehicular gate. A pedestrian gate shall not be incorporated into an automated vehicular gate panel.

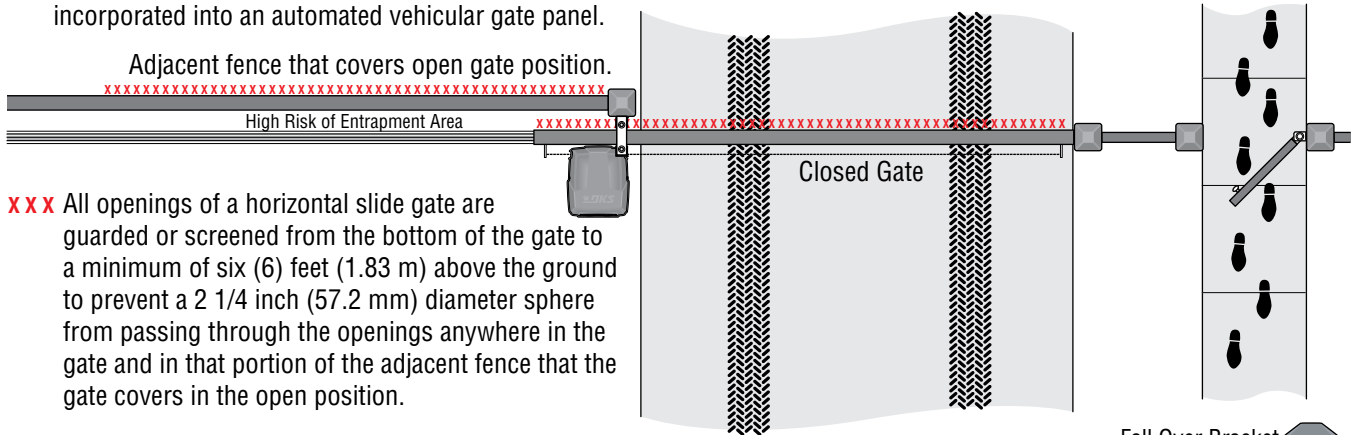

## Screened Wire Mesh Less than 2 1/4"

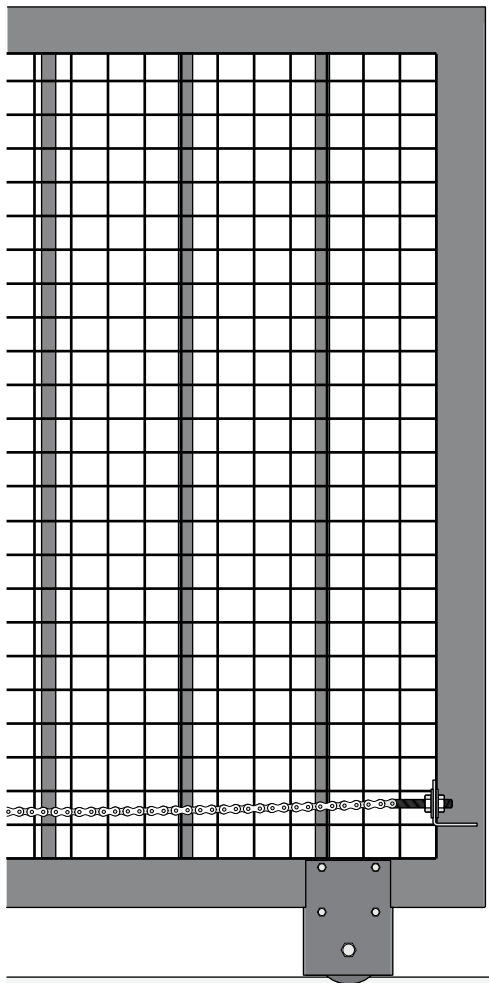

DoorKing recommends installing screened wire mesh on the **ENTIRE** gate **AND** on that portion of the adjacent fence that the gate covers in the open position. (See above).

Gates shall be designed, constructed and installed to not fall over more than 45 degrees from the vertical plane, when a gate is detached from the supporting hardware.

A gap, measured in the horizontal plane parallel to the roadway, between a fixed stationary object nearest the roadway (such as a gate support post) and the gate frame when the gate is in either the fully open position or the fully closed position, shall not exceed 2 1/4 inch (57.2 mm).

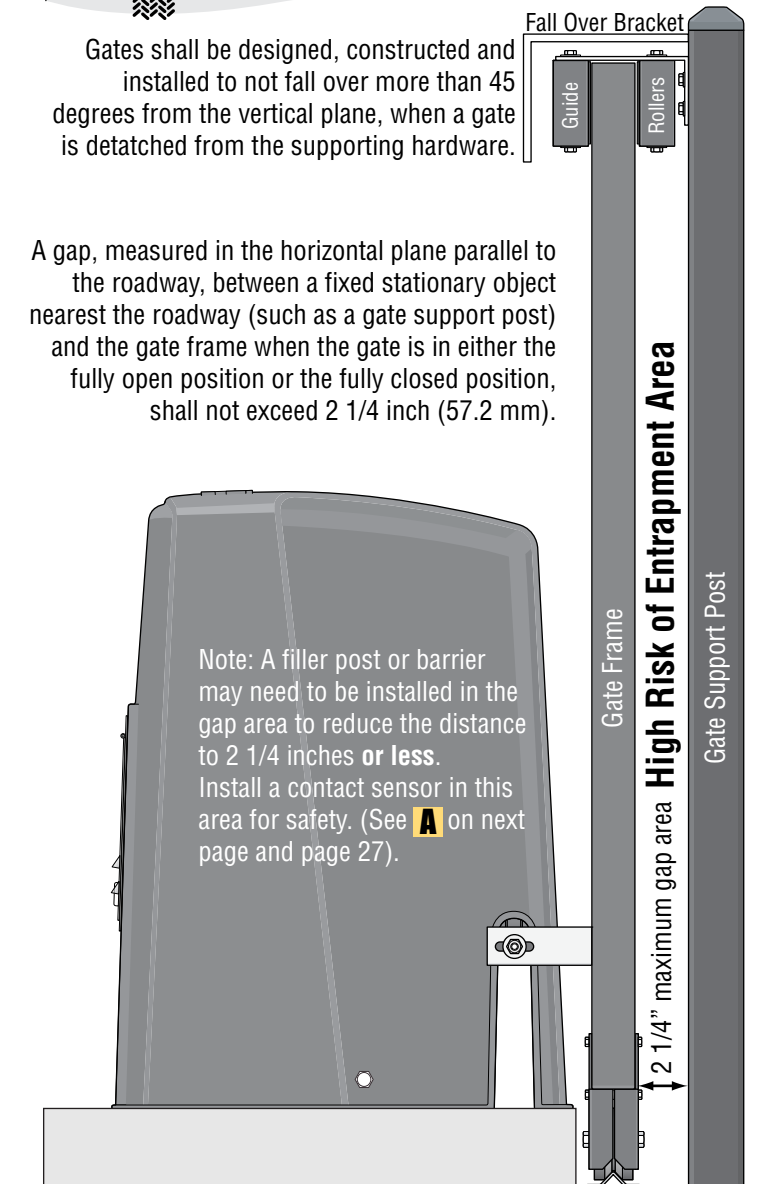

# Safety Information for Slide Gate Operators

Illustration not to scale.

Entrapment protection devices are required to reduce the risk of injury. Install sensors where the risk of entrapment or obstruction exists while gate is moving. **Individual requirements will vary.** See pages 26-28 for more information on typical layout locations and setup.

## Non-Contact Sensors (Photo Sensors)

- 1** Helps minimize the potential of entrapment during the closing cycle of the gate. Minimizes the potential of the gate closing on vehicular or other traffic that loops cannot sense. It can be installed on the secure **OR** non-secure side of gate.
- 2** Helps minimize the potential of entrapment during the back travel of the gate (opening cycle). See previous page for gate gap information.

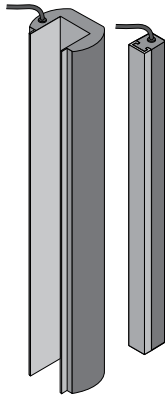

## Contact Sensor (Reversing Edges)

- A** Installed on the fence to help minimize the potential of entrapment between the gate and fence during the opening cycle of the gate. A filler post or barrier **MAY** need to be installed between fence and gate.
- B** Helps minimize the potential of entrapment during the back travel of the gate (opening cycle).
- C** Helps minimize the potential of entrapment during the closing cycle of the gate. Minimizes the potential of the gate closing on vehicular or other traffic that loops cannot sense.

## Guide Rollers

See previous page for more information.

## Physical Stops

Positive stops shall be required to limit travel to the designed fully open and fully closed positions. These stops shall be installed either at the top of the gate, or at the bottom of the gate where such stops shall horizontally or vertically project no more than is required to perform their intended function.

## Screened Wire Mesh

May be necessary on part of fence **AND** entire gate. See previous page for more information.

## Warning Sign

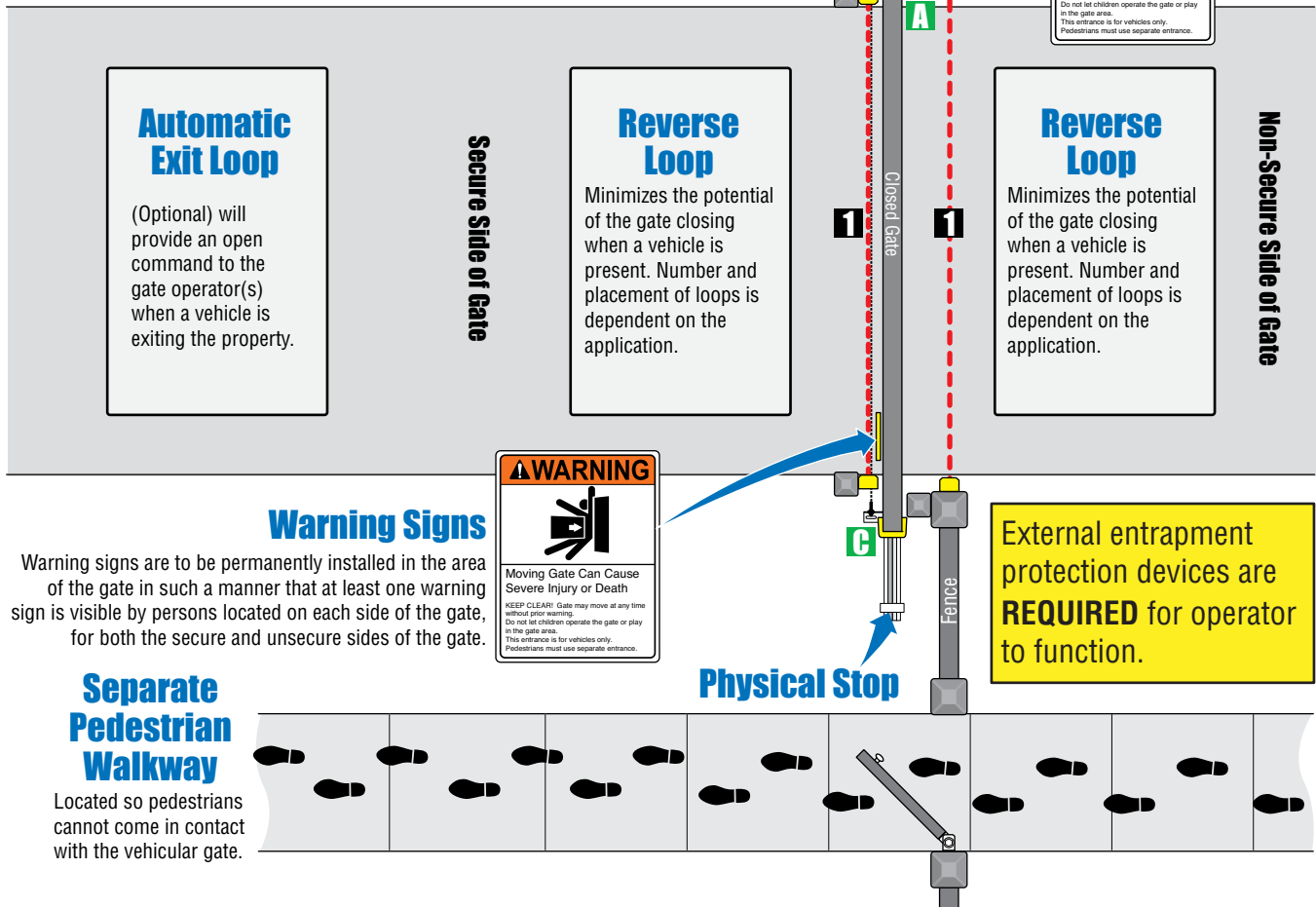

### Automatic Exit Loop

(Optional) will provide an open command to the gate operator(s) when a vehicle is exiting the property.

Secure Side of Gate

### Reverse Loop

Minimizes the potential of the gate closing when a vehicle is present. Number and placement of loops is dependent on the application.

### Reverse Loop

Minimizes the potential of the gate closing when a vehicle is present. Number and placement of loops is dependent on the application.

Non-Secure Side of Gate

## Warning Signs

Warning signs are to be permanently installed in the area of the gate in such a manner that at least one warning sign is visible by persons located on each side of the gate, for both the secure and unsecure sides of the gate.



## Separate Pedestrian Walkway

Located so pedestrians cannot come in contact with the vehicular gate.

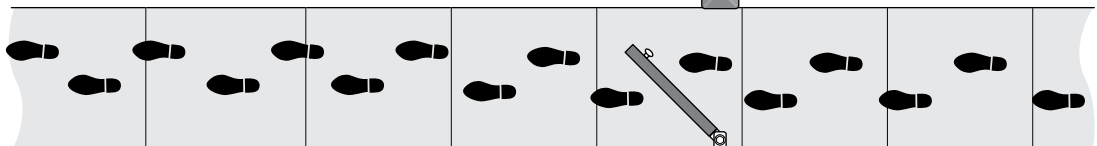

External entrapment protection devices are **REQUIRED** for operator to function.

# ASTM F2200 Standard for Gate Construction

Vehicular gates should be constructed and installed in accordance with ASTM F2200; Standard Specification for Automated Vehicular Gate Construction. For a copy of this standard, contact ASTM directly at 610-832-9585; service@astm.org; or www.astm.org.

## Important Safety Instructions

**WARNING - To reduce the risk of severe injury or death:**

1. READ AND FOLLOW ALL INSTRUCTIONS.
2. Never let children operate or play with gate controls. Keep the remote control away from children.
3. Always keep people and objects away from gate. **NO ONE SHOULD CROSS THE PATH OF THE MOVING GATE.**
4. Test the operator monthly. The gate **MUST** reverse on contact with a rigid object or stop or reverse when an object activates the non-contact sensors. After adjusting the force or the limit of travel, retest the gate operator. Failure to adjust and retest the gate operator properly can increase the risk of severe injury or death.
5. Use the manual release only when the gate is not moving.
6. **KEEP GATES PROPERLY MAINTAINED.** Read the owner's manual. Have a qualified service person make repairs to gate hardware.
7. The operator is intended for installation on gates used for vehicles. Pedestrians must be supplied with a separate access opening. The pedestrian access opening shall be designed to promote pedestrian usage. Locate the gate such that persons will not come in contact with the vehicular gate during the entire path of travel of the vehicular gate.
8. **SAVE THESE INSTRUCTIONS!**

## Instructions regarding intended installation:

- Install the gate operator only if:
  1. The operator is appropriate for the construction of the gate and the usage class of the gate.
  2. All openings of a horizontal slide gate are guarded or screened from the bottom of the gate to a minimum of 6 feet (1.83 m) above the ground to prevent a 2 ¼ inch (57.2 mm) diameter sphere from passing through the openings anywhere in the gate, and in that portion of the adjacent fence that the gate covers in the open position.
  3. All exposed pinch points are eliminated or guarded.
  4. Guarding is supplied for exposed rollers.
- The operator is intended for installation only on gates used for vehicles. Pedestrians must be supplied with a separate access opening. The pedestrian access opening shall be designed to promote pedestrian usage. Locate the gate such that persons will not come in contact with the vehicular gate during the entire path of travel of the vehicular gate.
- The gate must be installed in a location so that enough clearance is supplied between the gate and adjacent structures when opening and closing to reduce the risk of entrapment. Swinging gates should not open into public access areas.
- The gate must be properly installed and work freely in both directions prior to the installation of the gate operator. Do not over-tighten the operator clutch, pressure relief valve or reduce reversing sensitivity to compensate for a damaged gate.
- For gate operators utilizing Type D protection:
  1. The gate operator controls must be placed so that the user has full view of the gate area when the gate is moving.
  2. A warning placard shall be placed adjacent to the controls.
  3. An automatic closing device (such as a timer, loop sensor, or similar device) shall not be employed.
  4. No other activation device shall be connected.
- Controls intended for user activation must be located at least six feet (6') away from any moving part of the gate and where the user is prevented from reaching over, under, around or through the gate to operate the controls. Outdoor or easily accessible controls should have a security feature to prevent unauthorized use.
- The Stop and/or Reset button must be located in the line-of-sight of the gate. Activation of the reset control shall not cause the operator to start.
- Warning signs are to be permanently installed in the area of the gate in such a manner that at least one warning sign is visible by persons located on each side of the gate, for both the secure and unsecure sides of the gate.
- For gate operators utilizing a non-contact sensor:
  1. See the instructions on the placement of non-contact sensors for each type of application.
  2. Care shall be exercised to reduce the risk of nuisance tripping, such as when a vehicle trips the sensor while the gate is still moving in the opening direction.
  3. One or more non-contact sensors shall be located where the risk of entrapment or obstruction exist, such as the perimeter reachable by a moving gate or barrier.
- For gate operators utilizing contact sensors:
  1. One or more contact sensors shall be located where the risk of entrapment or obstruction exist, such as at the leading edge, trailing edge, and post mounted both inside and outside of a vehicular horizontal slide gate.
  2. One or more contact sensors shall be located at the bottom edge of a vehicular vertical lift gate.
  3. One or more contact sensors shall be located at the pinch point of a vehicular vertical pivot gate.
  4. A hardwired contact sensor shall be located and its wiring arranged so that the communication between the sensor and the gate operator is not subjected to mechanical damage.
  5. A wireless contact sensor such as one that transmits radio frequency (RF) signals to the gate operator for entrapment protection functions shall be located where the transmission of the signals are not obstructed or impeded by building structures, natural landscaping or similar obstructions. A wireless contact sensor shall function under the intended end-use conditions.
  6. One or more contact sensors shall be located at the bottom edge of a vertical barrier (arm).
- Be sure you have instructed the owner of the gate operator about safe and proper operation and testing of the gate operator.



# Important Notices

Vehicular gate operator products provide convenience and security. However, gate operators must use high levels of force to move gates and most people underestimate the power of these systems and do not realize the potential hazards associated with an incorrectly designed or installed system. These hazards may include:

- Pinch points
- Entrapment areas
- Reach through hazards
- Absence of entrapment protection devices
- Improperly located access controls
- Absence of vehicle protection devices
- Absence of controlled pedestrian access

In addition to these potential hazards, automated vehicular gate systems must be installed in accordance with the UL 325 Safety Standard and the ASTM F2200 Construction Standard. Most people are unaware of, or are not familiar with, these standards. If an automated vehicular gate system is not properly designed, installed, used and maintained, severe injuries or death can result. Be sure that the installer has instructed you on the proper operation of the gate and gate operator system.

Be sure that the installer has trained you on proper and safe operation of this gate operating system and about the basic functions of the required reversing systems associated with your gate operating system and how to test them (see section 8). These include reversing loops, inherent reversing system, electric edges, photoelectric cells, or other external devices.

- This Owner's Manual is your property. Keep it in a safe place for future reference.
- Be sure that all access control devices are installed a minimum distance of 6 feet away from the gate and gate operator, or in such a way that a person cannot touch the gate or gate operator while using the device. If access control devices are installed in violation of these restrictions, immediately remove the gate operator from service and contact your installing dealer.

**Opening device MUST be mounted a minimum of 6 feet from the gate and NOT accessible through the gate!**



- Loops and loop detectors, photo-cells or other equivalent devices must be installed to prevent the gate from closing on vehicular traffic.
- The speed limit for vehicular traffic through the gate area is 5 MPH. Install speed bumps and signs to keep vehicular traffic from speeding through the gate area. Failure to adhere to posted speed limits can result in damage to the gate, gate operator, and to the vehicle.
- Be sure that all persons who will use the gate system are familiar with the proper use of the gate and gate operator and are familiar with the possible hazards associated with the gate system.
- Warning signs are to be permanently installed in the area of the gate in such a manner that at least one warning sign is visible by persons located on each side of the gate, for both the secure and unsecure sides of the gate.
- It is your responsibility to periodically check all entrapment protection devices. If any of these devices are observed to function improperly, remove the operator from service immediately and contact your installing or servicing dealer.
- Follow the recommended maintenance schedule.
- Do not allow children to play in the area of the operator or to play with any gate-operating device.
- To remove the gate operator from service, operate the gate to the full open position and then shut off power to the operator at the service panel.

# UL 325 Entrapment Protection

## UL 325 Classifications



### Class I - Residential Vehicular Gate Operator

A vehicular gate operator (or system) intended for use in garages or parking areas associated with a residence of one-to four single families.



### Class III - Industrial/Limited Access Vehicular Gate Operator

A vehicular gate operator (or system) intended for use in an industrial location or building such as a factory or loading dock area or other locations not accessible by or intended to service the general public.

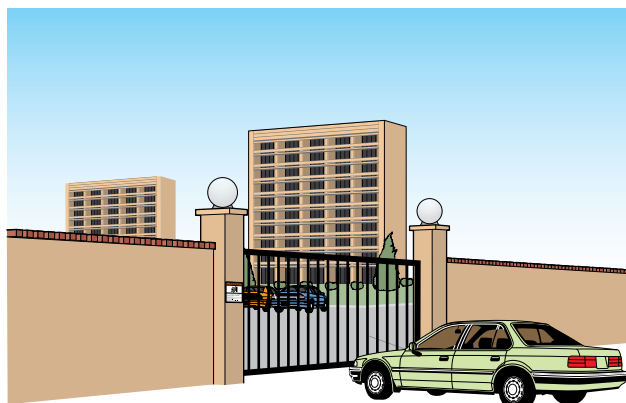

### Class II - Commercial/General Access Vehicular Gate Operator

A vehicular gate operator (or system) intended for use in a commercial location or building such as a multi-family housing unit (five or more single family units), hotel, garages, retail store, or other buildings accessible by or servicing the general public.



### Class IV - Restricted Access Vehicular Gate Operator

A vehicular gate operator (or system) intended for use in a guarded industrial location or building such as an airport security area or other restricted access locations not servicing the general public, in which unauthorized access is prevented via supervision by security personnel.

## Gate Operator Category

	Horizontal Slide, Vertical Lift, Vertical Pivot, Horizontal Bifold	Swing, Vertical Barrier (Arm)
Entrapment Protection Types	A, B1*, B2* or D	A, B1*, B2*, C or D

**Type A** - Inherent entrapment protection system.

**Type B1** - Non-contact sensor (photoelectric sensor or the equivalent).

**Type B2** - Contact sensor (edge device or equivalent).

**Type C** - Inherent force limiting, inherent adjustable clutch or inherent pressure relief device.

**Type D** - Actuating device requiring constant pressure to maintain opening or closing motion of the gate.

\* B1 and B2 means of entrapment protection must be MONITORED.

**Vertical Barrier Note:** Barrier gate operators (arm) that is not intended to move toward a rigid object closer than 16 inches (406 mm) are not required to be provided with a means of entrapment protection.

# Glossary

**GATE** - A moving barrier such as a swinging, sliding, raising, lowering, folding, pivoting, or the like, barrier, that is a stand-alone passage barrier or is that portion of a wall or fence system that controls entrance and/or egress by persons or vehicles and completes the perimeter of a defined area.

**RESIDENTIAL VEHICULAR GATE OPERATOR – CLASS I** - A vehicular gate operator (or system) intended for use in a home of one-to four single family dwelling, or garage or parking area associated therewith.

**COMMERCIAL / GENERAL ACCESS VEHICULAR GATE OPERATOR - CLASS II** - A vehicular gate operator (or system) intended for use in a commercial location or building such as a multi-family housing unit (five or more single family units), hotels, garages, retail store, or other building servicing the general public.

**INDUSTRIAL / LIMITED ACCESS VEHICULAR GATE OPERATOR - CLASS III** - A vehicular gate operator (or system) intended for use in an industrial location or building such as a factory or loading dock area or other locations not intended to service the general public.

**RESTRICTED ACCESS VEHICULAR GATE OPERATOR - CLASS IV** - A vehicular gate operator (or system) intended for use in a guarded industrial location or building such as an airport security area or other restricted access locations not servicing the general public, in which unauthorized access is prevented via supervision by security personnel.

**VEHICULAR BARRIER (ARM) OPERATOR (OR SYSTEM)** - An operator (or system) that controls a cantilever type device (or system), consisting of a mechanical arm or barrier that moves in a vertical arc, intended for vehicular traffic flow at entrances or exits to areas such as parking garages, lots or toll areas.

**VEHICULAR HORIZONTAL SLIDE-GATE OPERATOR (OR SYSTEM)** - A vehicular gate operator (or system) that controls a gate which slides in a horizontal direction that is intended for use for vehicular entrance and exit to a drive, parking lot, or the like.

**VEHICULAR SWING-GATE OPERATOR (OR SYSTEM)** - A vehicular gate operator (or system) that controls a gate which moves in an arc in a horizontal plane that is intended for use for vehicular entrance and exit to a drive, parking lot, or the like.

**SYSTEM** - In the context of these requirements, a system refers to a group of interacting devices intended to perform a common function.

**WIRED CONTROL** - A control implemented in a form of fixed physical interconnections between the control, the associated devices, and an operator to perform predetermined functions in response to input signals.

**WIRELESS CONTROL** - A control implemented in means other than fixed physical interconnections (such as radio waves or infrared beams) between the control, the associated devices, and an operator to perform predetermined functions in response to input signals.

**INHERENT ENTRAPMENT PROTECTION SYSTEM** - A system, examples being a motor current or speed sensing system, which provides protection against entrapment upon sensing an object and is incorporated as a permanent and integral part of the operator.

**EXTERNAL ENTRAPMENT PROTECTION DEVICE** - A device, examples being an edge sensor, a photoelectric sensor, or similar entrapment protection device, which provides protection against entrapment when activated and is not incorporated as a permanent part of an operator.

**ENTRAPMENT** - The condition when a person is caught or held in a position that increases the risk of injury.

# SECTION 1 - INSTALLATION

Prior to beginning the installation of the slide gate operator, we suggest that you become familiar with the instructions, illustrations, and wiring guide-lines in this manual. This will help insure that your installation is performed in an efficient and professional manner compliant with UL 325 safety and ASTM F2200 construction standards.

The proper installation of the vehicular slide gate operator is an extremely important and integral part of the overall access control system. Check all local building ordinances and building codes prior to installing this operator. Be sure your installation is in compliance with local codes.

## 1.1 Hardware for the Gate

Good hardware is essential for proper operation of a sliding gate. DoorKing has a full line of gate hardware products that will ensure safe, reliable and long lasting gate operation. The gate must be properly installed and roll smoothly in both directions.

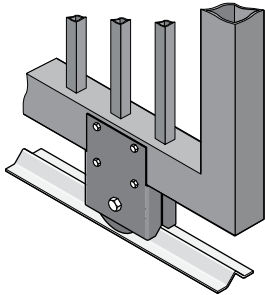

**Roller Bearing V-Wheels with Protective Cover** - Helps to minimize a pinch point on the gate's wheel and V-rail.

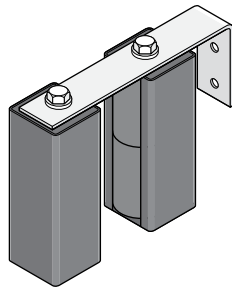

**Guide Rollers with Protective Covers** - Helps to minimize a pinch point on the gate.

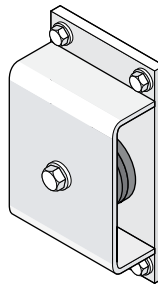

**Endless Idler Assembly with Protective Cover** - Helps to minimize a pinch point for a 180° chain return.

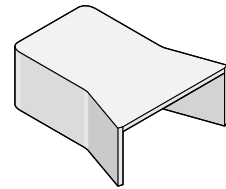

**Gate End Retainer** - Helps stabilize the end of the gate in the open or closed position.

## 1.2 Underground Conduit Requirements

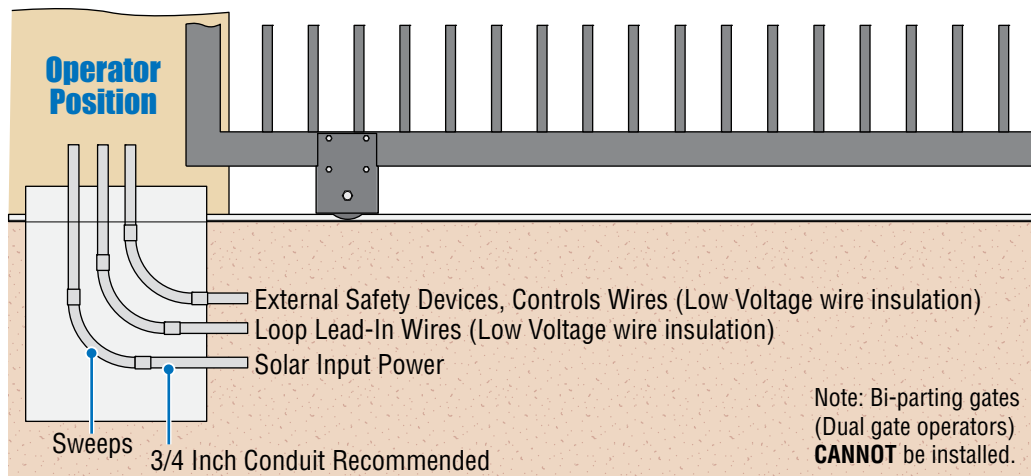

- The conduit requirements are for a typical slide gate operator installation. **The conduit requirements for your application may vary from this depending on your specific needs.**
- Use only sweeps for conduit bends. Do not use 90° elbows as this will make wire pulls very difficult and can cause damage to wire insulation. DoorKing recommends using 3/4-inch conduit.
- Installation of **External Entrapment Protection Devices** are **REQUIRED** (photo sensors and/or reversing edges).
- Be sure that all conduits are installed in accordance with local codes.
- **Never** run low voltage rated wire insulation in the same conduit as high voltage rated wire insulation.

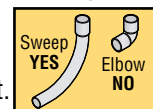

## 1.3 Typical Gate Types

The Model 9024 operator is designed to be installed on any of these gate types. See pages 12-14 for specific operator mounting positions.

- Steel or Aluminum.
- 1,000 lb max. weight per gate.
- Chain tray recommended for gates over 20 ft.  
(Post mount installation when using a chain tray.)
- 40 ft max gate length.

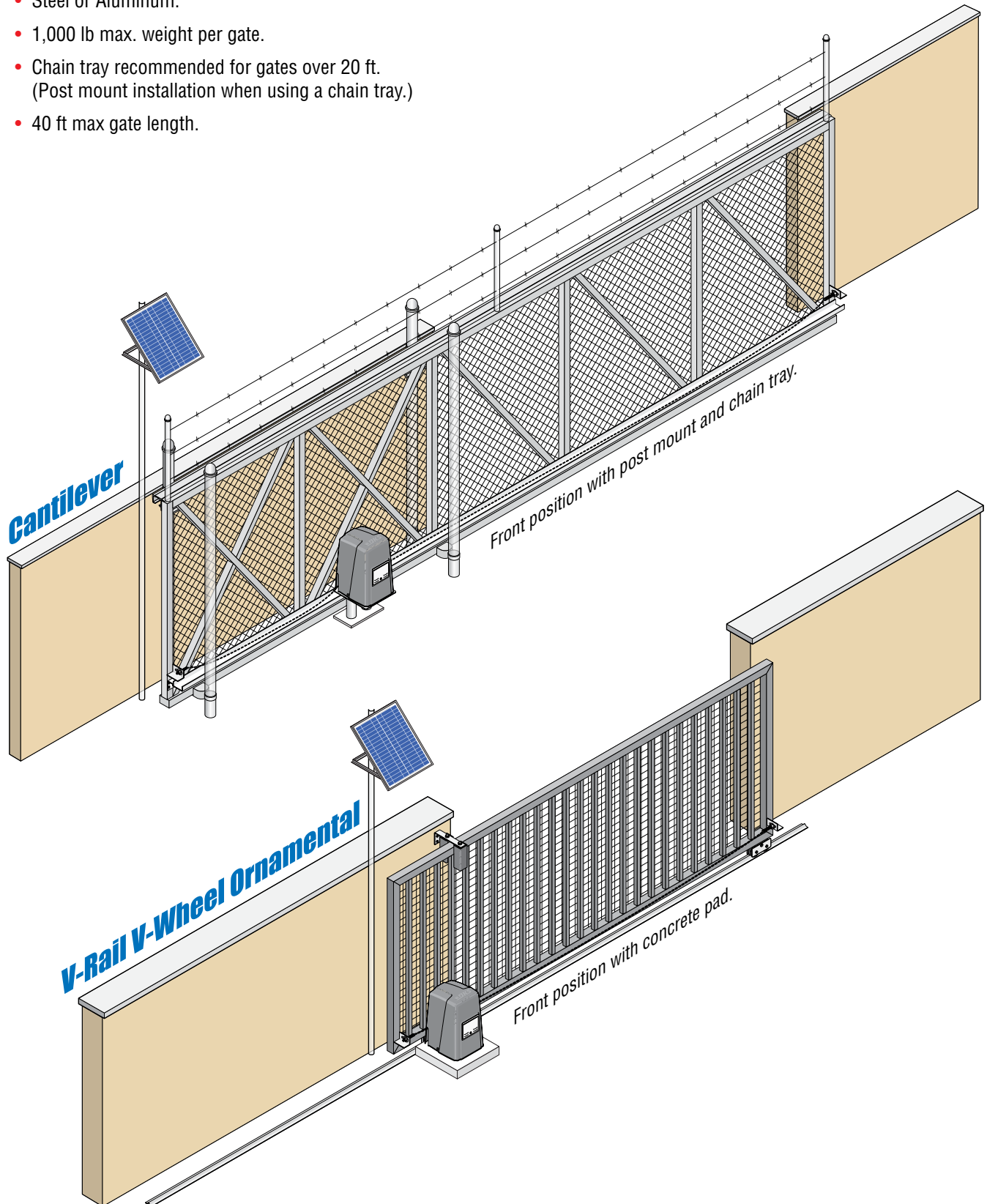

## 1.4 Concerns BEFORE Solar Panel Installation

Correct positioning of the solar panel will determine the efficiency of the system. In general, the panel should be facing **TRUE SOUTH** at a specific **TILT ANGLE** towards the sun using the information provided on the next page to achieve the highest efficiency. Some re-adjustment of the panel might be necessary to over time to “Fine Tune” the systems efficiency. The solar panel should be installed as close as possible to the operator in an area free and clear of **ALL** obstructions and shadows during the **ENTIRE** day. Generally, If the solar panel does **NOT** cast a shadow by the sun, the batteries are **NOT** being charged.

- **Trees / Buildings** that do not block the solar panel from direct sunlight in the summer, **could** block the panel during the winter. The sun’s path across the sky is lower during the winter than in the summer. The shadows that do not obstruct the solar panel during the summer months, will cast longer shadows in the winter, which could block the panel then.
- **Wind** can exert extreme pressure on the solar panel and support post. Make sure they are securely fastened.
- **Dust** can accumulate on the panel over time. Cleaning the panel every so often is necessary to keep the system operating at its highest efficiency.
- **Snow** may cover the panel during the winter. You may want to re-adjust the panel to a steeper angle to allow the snow to slide off. Even then, the panel may still accumulate snow and need to be manually cleaned off when necessary to keep the system functioning.

### Mounting Recommendations

The solar panel will perform **MOST** efficient when installed as close as possible to the operator (Within a couple of feet). Keep in mind, the efficiency of the solar panel will diminish the farther away the panel is installed from the operator.

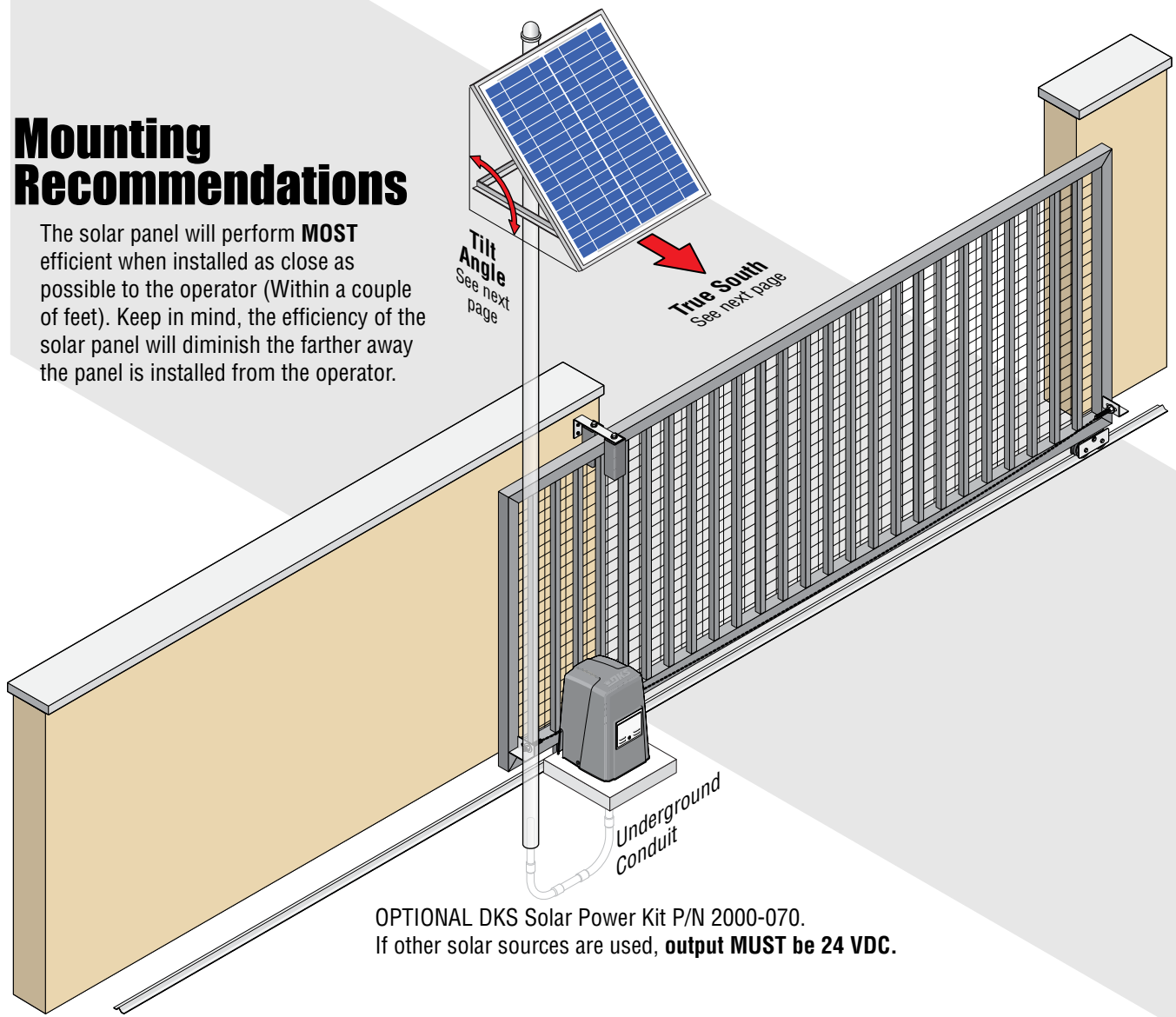

OPTIONAL DKS Solar Power Kit P/N 2000-070.  
If other solar sources are used, **output MUST be 24 VDC.**

# 1.5 Solar Panel Positioning

These charts should be used only for estimates. Solar systems can vary from this information. These maps do not take into account small climate changes and may not be 100% accurate for all locations.

## Solar Panel MUST Point "TRUE SOUTH"

It is important for proper system operation that the solar panel is oriented to **TRUE SOUTH**. The directions of magnetic South and TRUE South differ from one another depending on geographic location. The map below shows the difference between magnetic south and TRUE south for your area.

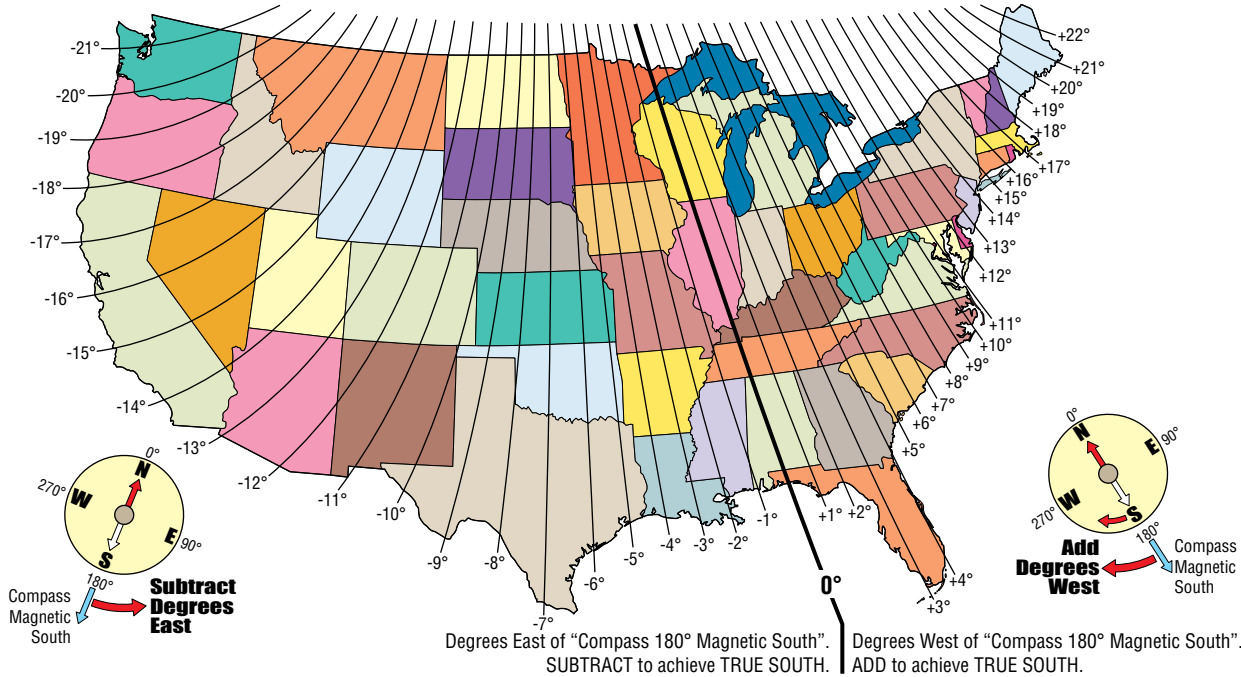

## General Solar Panel "Tilt Angle"

It is simplest to mount the solar panel at a fixed tilt angle and leave it (Shown on chart below). To capture more energy from the sun, you can adjust the tilt angle of the solar panel twice a year (At the beginning of summer and winter). Add approximately 6° in the summer and subtract approximately 6° in the winter from your "general" tilt angle on this chart. Your tilt angle may vary from this.

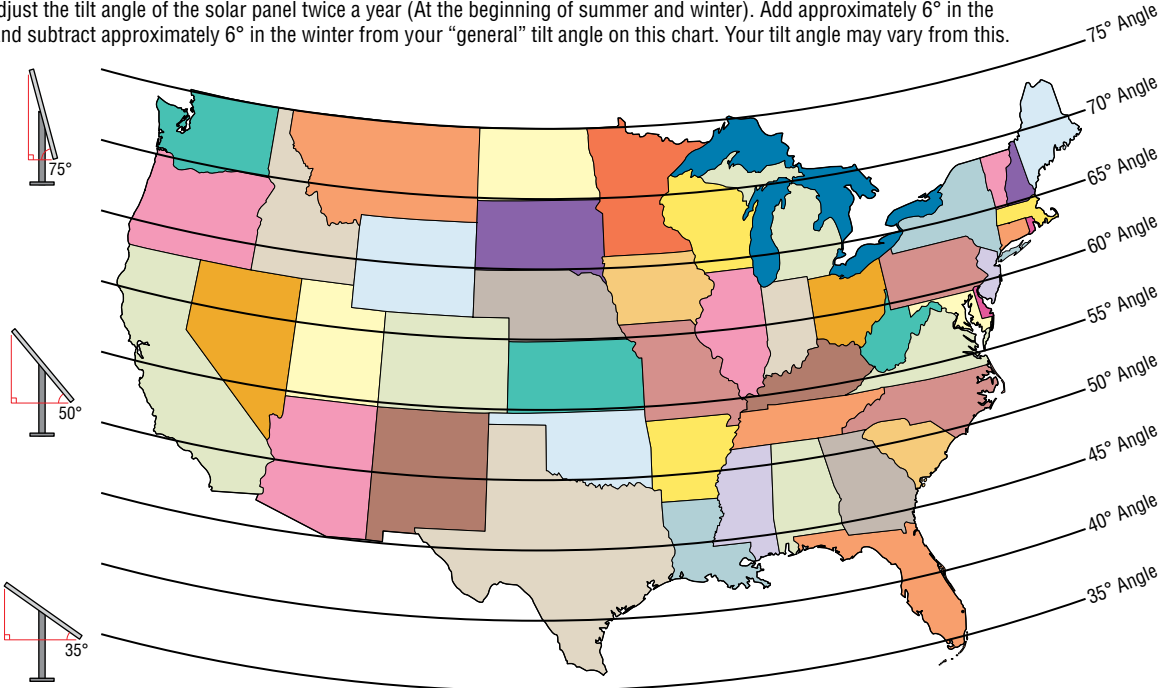

# 1.6 Operator Mounting Positions

The Model 9024 operator is designed to be installed in the front, rear and center mounting positions shown on this page and the next 2 pages. V-wheel V-rail ornamental gates are shown as examples but other gate types on the previous page can use the same mounting setups. Once the mounting position has been selected, refer to pages 15 thru 18 for specific installation instructions.

## Front Position with Concrete Pad

Standard method of installation.

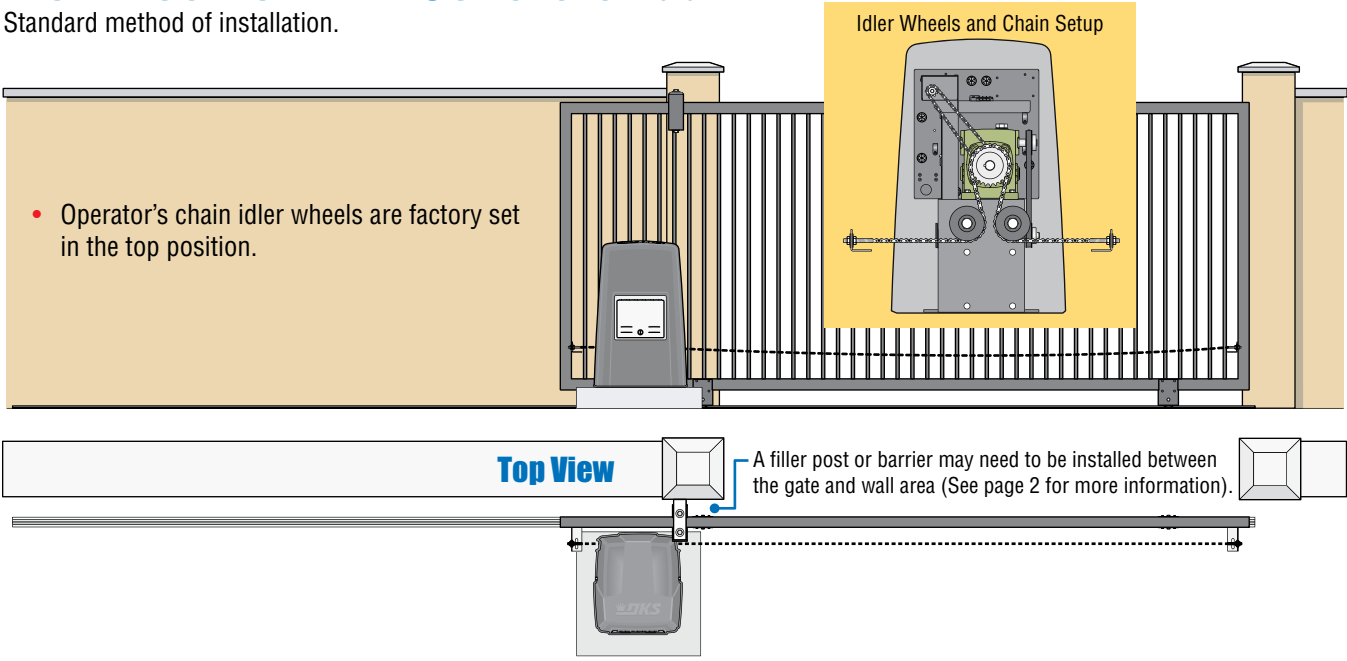

## Front Position with Post Mount Kit

Raises operator and allows different chain heights.

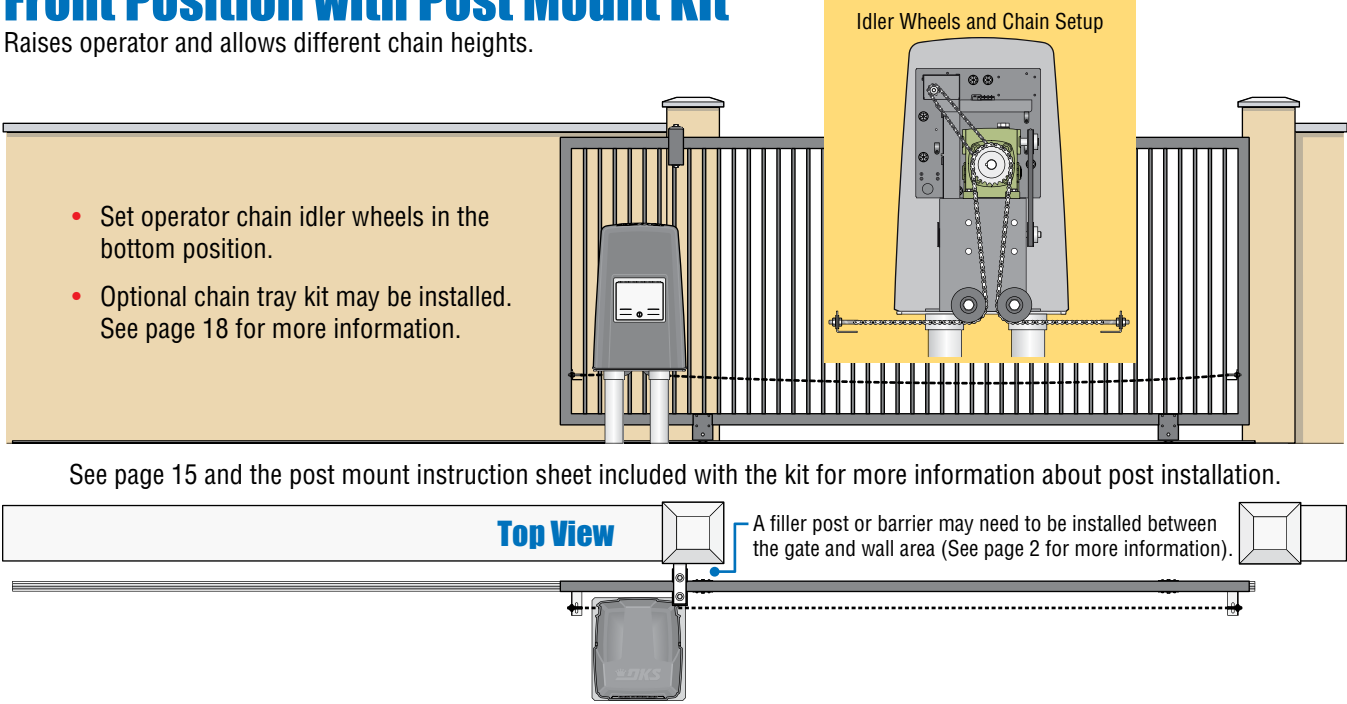

**Additional hardware required.** Post mount kit (P/N 9000-015).



## Rear Position with Concrete Pad

Hides the chain from outside the property looking in.

- Set one chain Idler wheel at the top and one in the center position.

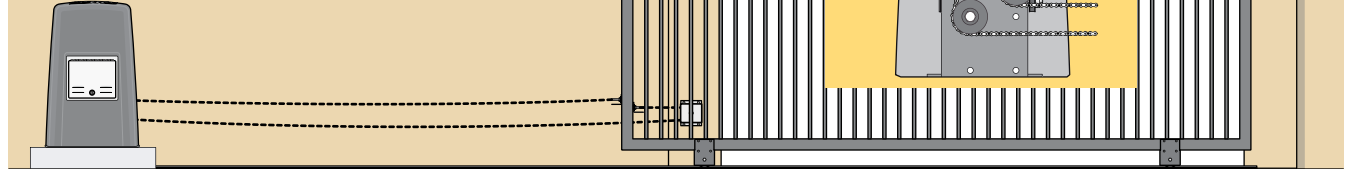

### Top View



A filler post or barrier may need to be installed between the gate and wall area (See page 2 for more information).

**Additional hardware required.** Endless idler assembly (P/N 2600-818) and additional chain #40 (P/N 2600-442 - 20 ft. per box) may be needed.

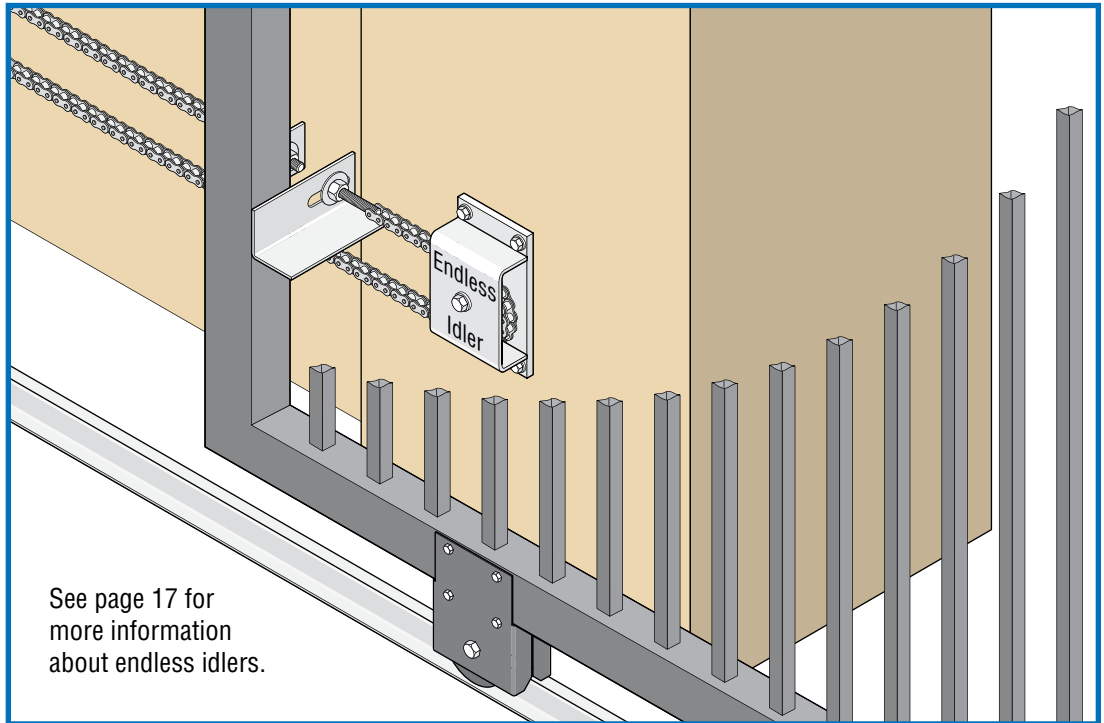

## Rear Position with Post Mount Kit

Raises operator and allows different chain heights.

- Set one chain Idler wheel at the center and one in the bottom position.
- See page 17 and the post mount instruction sheet included with the kit for more information about post installation.

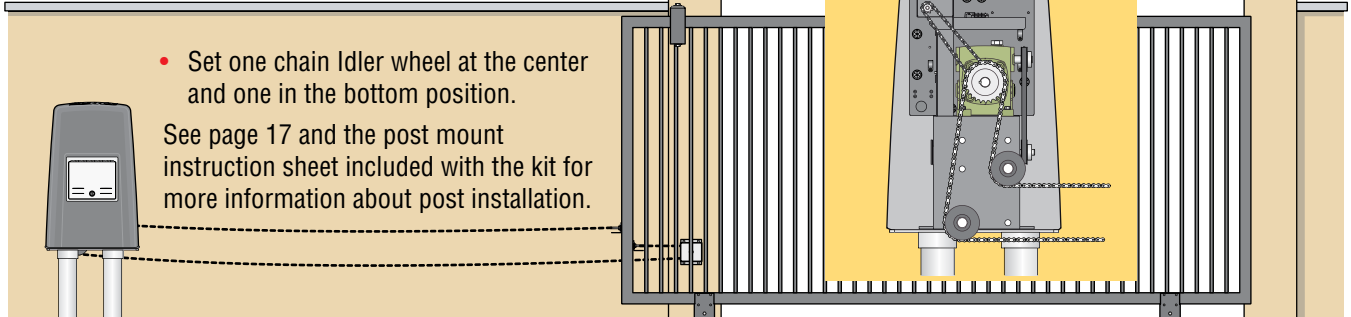

**Additional hardware required.** Post mount kit (P/N 9000-015). Endless idler assembly (P/N 2600-818) and additional chain #40 (P/N 2600-442 - 20 ft. per box) may be needed.

# Center Position with Post Mount Kit

Hides the chain from outside the property looking in. Allows the use of DoorKing's chain tray kit to attach to gate. This is useful with long gates. It supports the chain's weight and helps prevent chain "stretching".

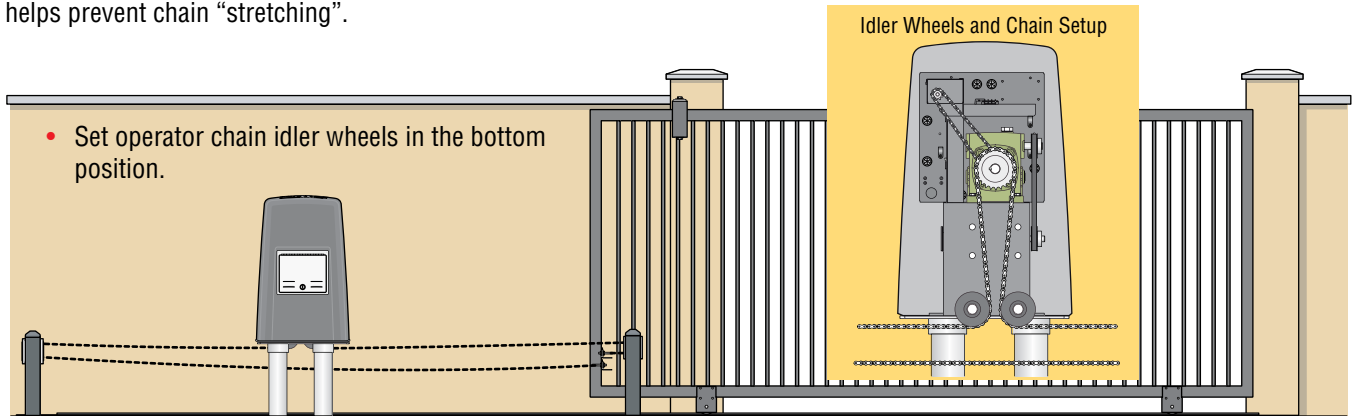

See next page and the post mount instruction sheet included with the kit for more information about post installation.

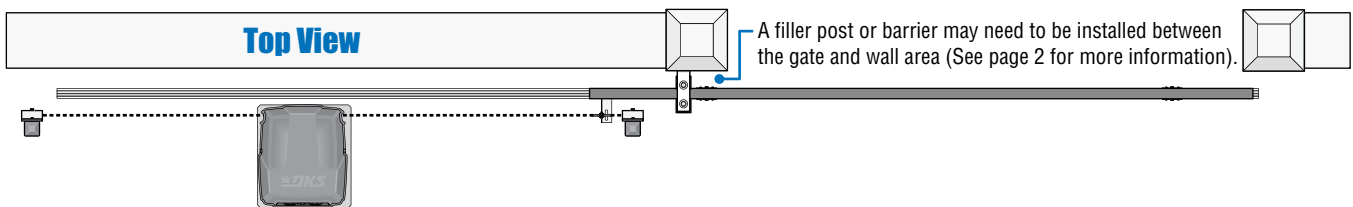

**Additional hardware required.** Post mount kit (P/N 9000-015). Endless idler assembly (P/N 2600-818) and additional chain #40 (P/N 2600-442 - 20 ft. per box) may be needed.

## Gate in Open Position

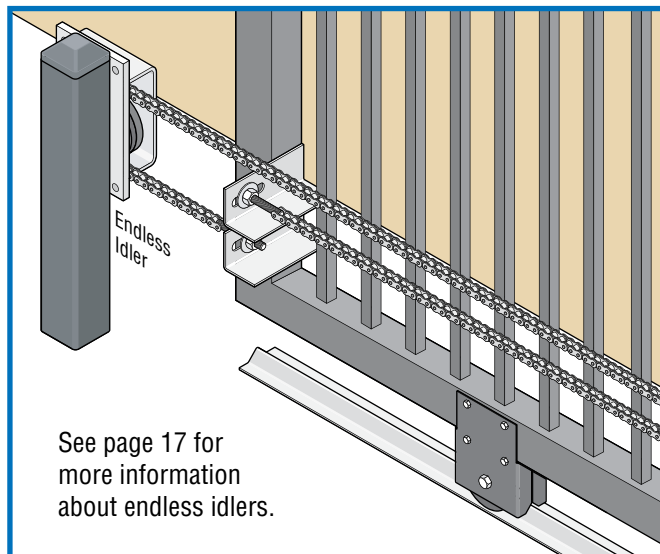

## Gate in Close Position

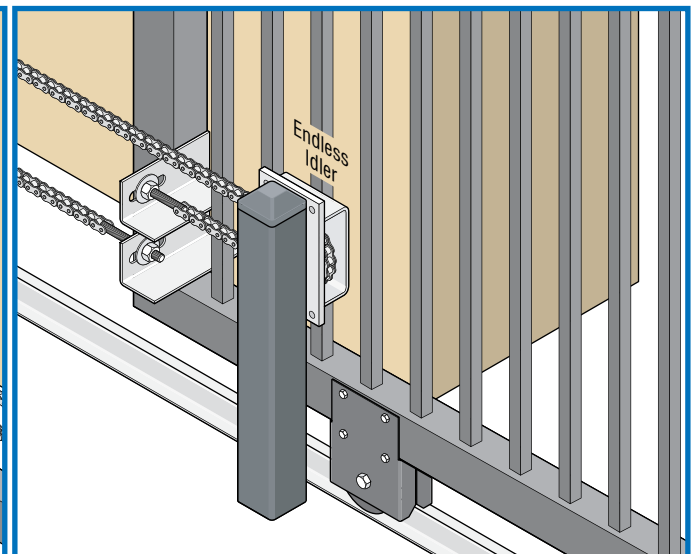

## DoorKing's Chain Tray Kit for Long Gates

See page 18 for more information.

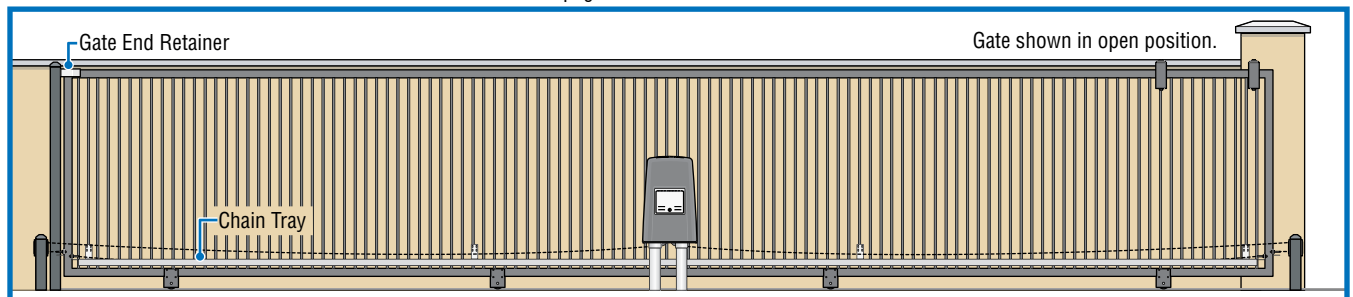

# 1.7 Concrete Pad Setup OR Post Mounting

## Concrete Pad Setup

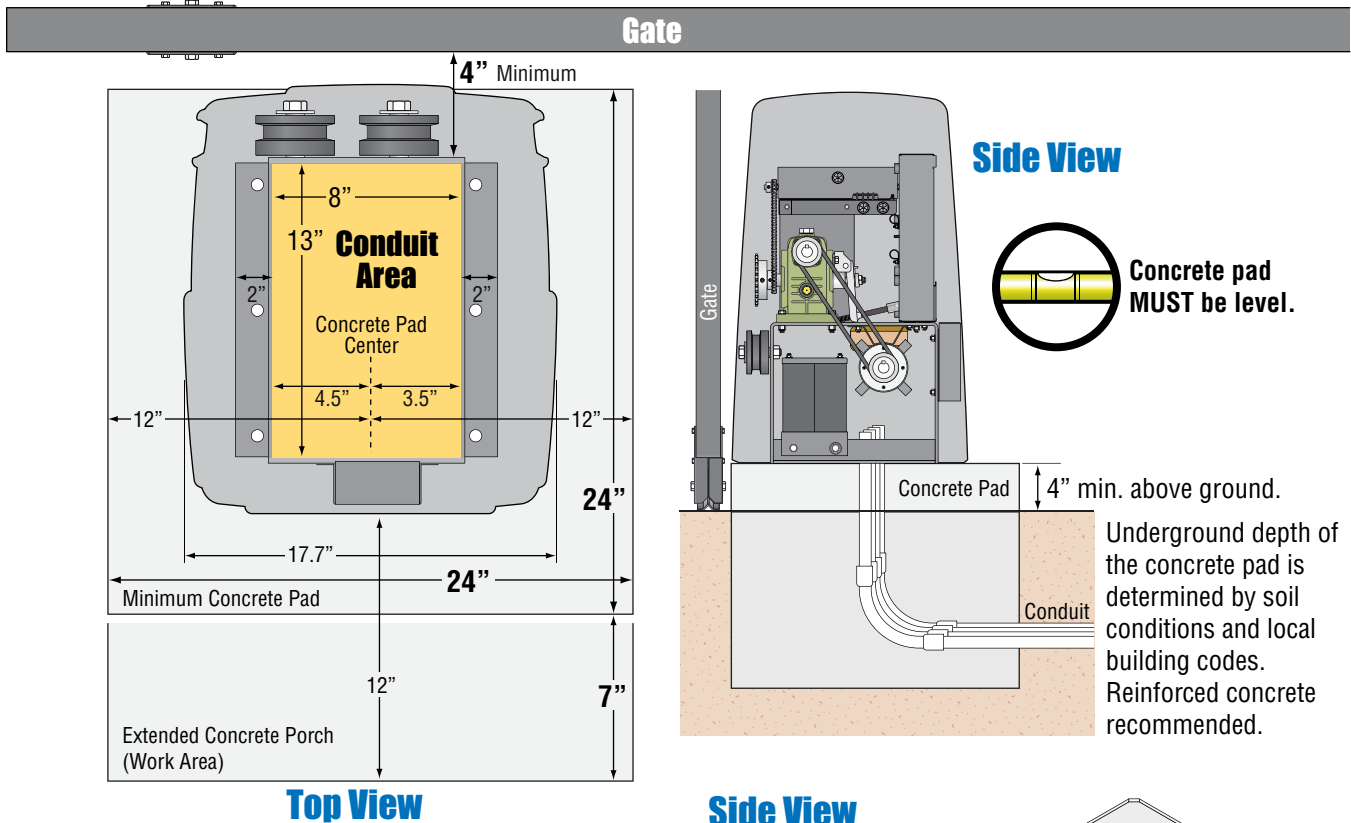

## Optional Post Mount Kit

DoorKing offers a post mount kit specifically for the Model 9024 (P/N 9000-015). The kit includes a base plate, 2 posts and hardware to attach the operator to the base plate. This kit will raise the operator and allow different chain heights for specific operator applications. Refer to the instruction sheet provided with the kit for concrete foundation size, conduit type and placement. This kit is needed if a chain tray is required to support the chain's weight when a longer gate is used (See page 18 for more information about DoorKing's chain tray kit).

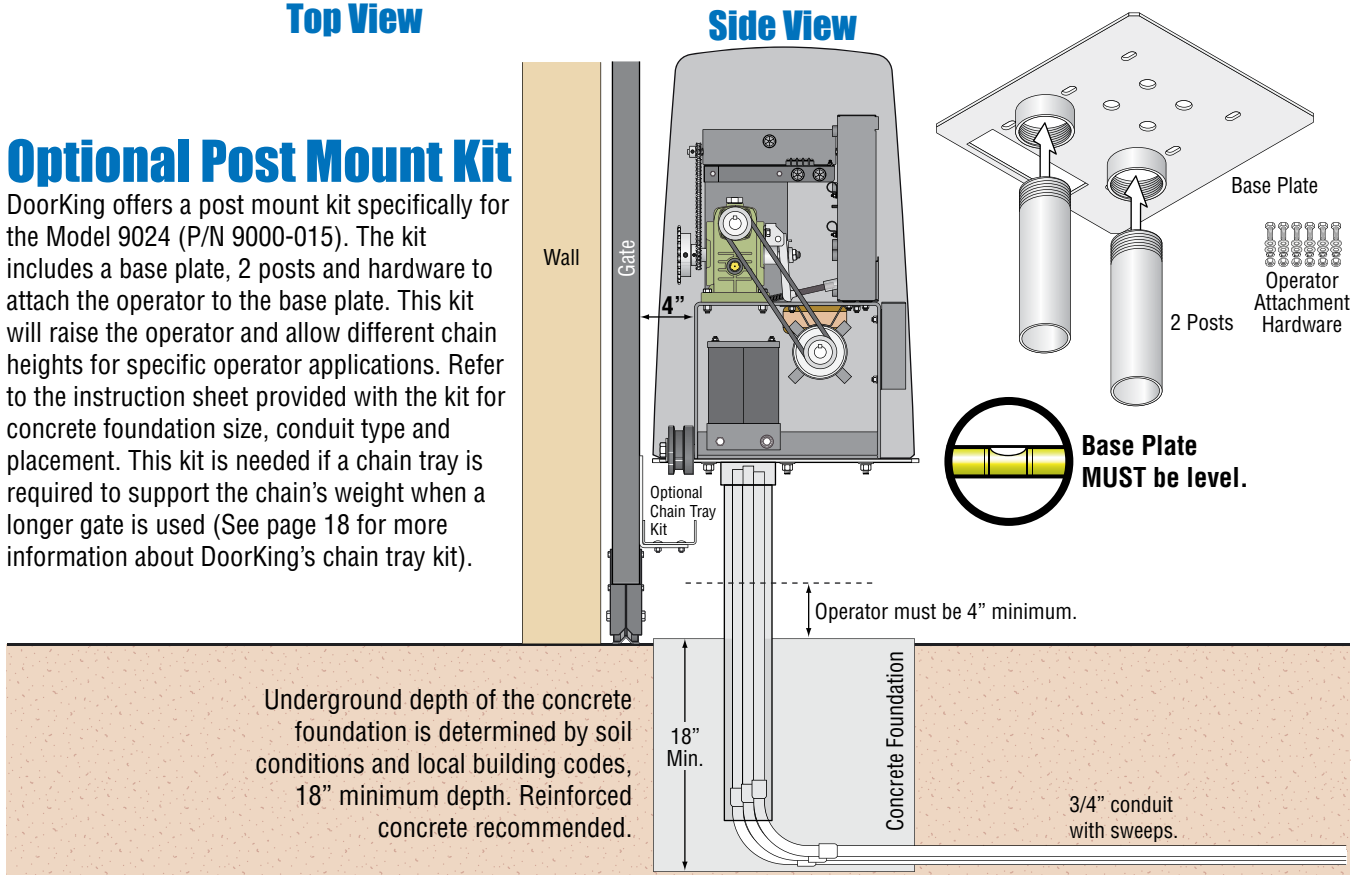

# 1.8 Positioning Operator and Chain

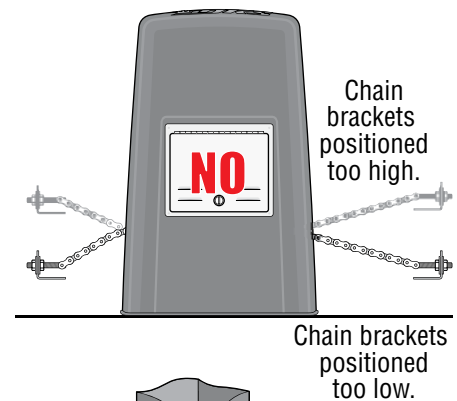
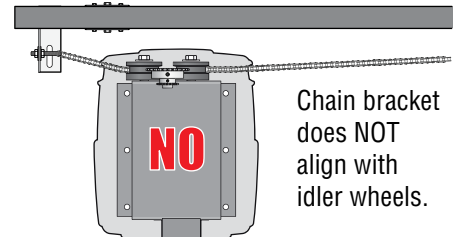
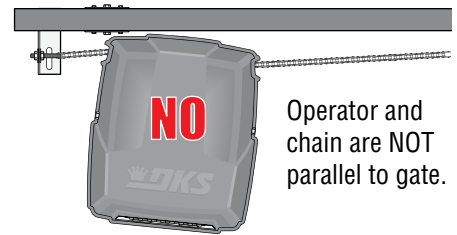
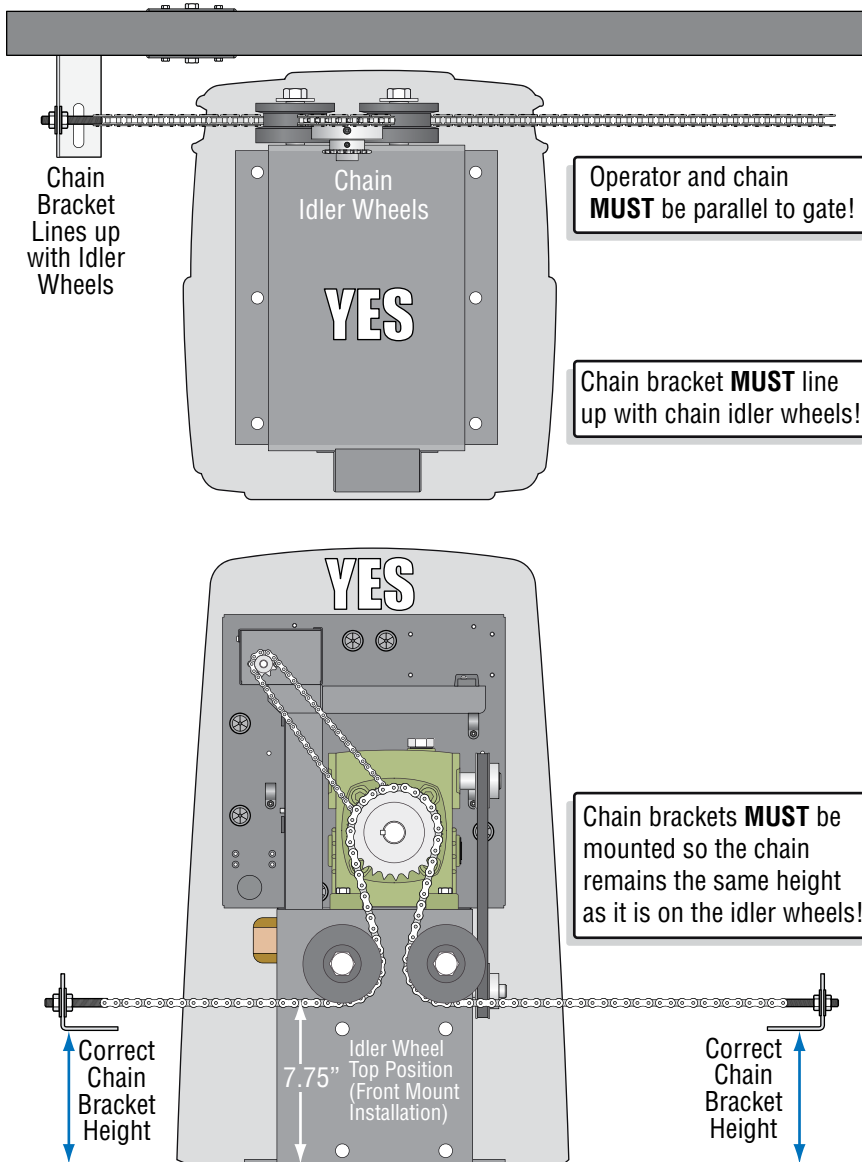

# 1.9 Attaching Operator and Chain

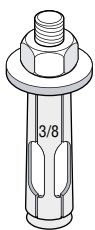

## Attaching Operator to Concrete Pad

DoorKing recommends a minimum of four (4) 3/8" x 2" sleeve anchors (not supplied).

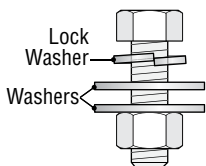

## Attaching Operator to Post Mount Plate

Use bolts provided in post mount kit.

## Connect Chain Bracket to Gate.

Weld completely around bracket. **Chain nut and chain bolt should not protrude past gate frame.**

## Connect Chain to Chain Bracket.

Connect chain to chain bolt with master link. Adjust the chain nuts to tighten the chain. The chain should sag no more than one (1) inch per 10 feet of travel. **Do not over tighten the chain.**

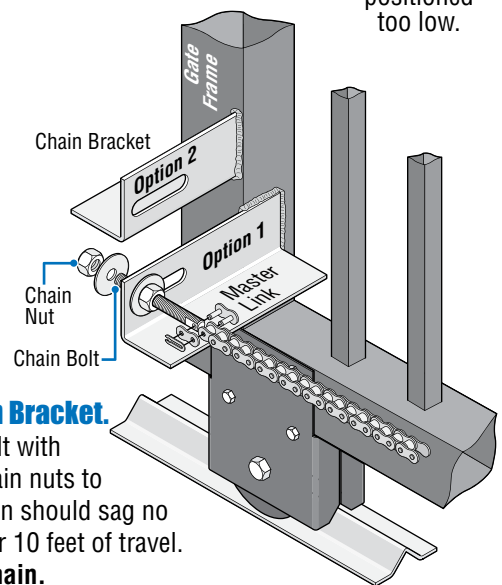

# 1.10 Endless Idler Assembly (On Select Installations)

DoorKing offers an endless idler assembly with a protective cover designed for the Model 9024 installations (P/N 2600-818). Make sure the endless idler assembly is **securely** fastened to the wall or post (Depending on which type of installation will be used). Extreme force will be exerted on this assembly during gate cycling.

## Center and Rear Mount Positions (Top View)

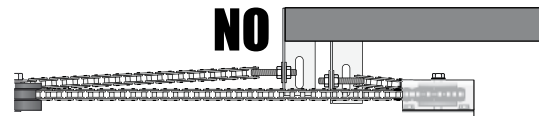
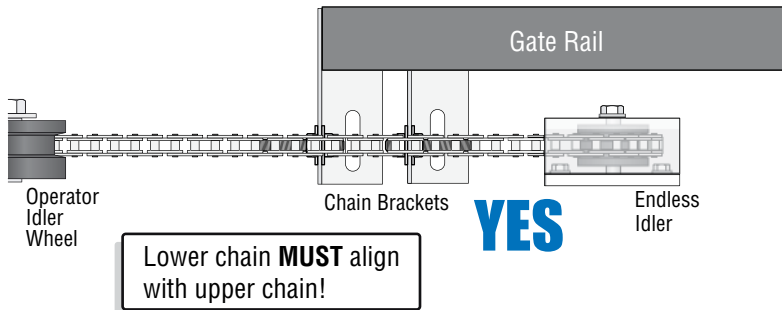

Lower chain does NOT align with upper chain. Note: Be sure that the chain is aligned and parallel to the gate. Installing the chain in any other manner will cause excessive noise, chain idler wheel wear and chain stretching.

## Center Mount Position (Side View)

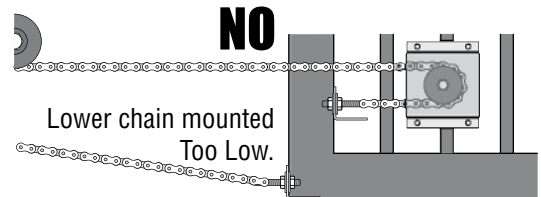
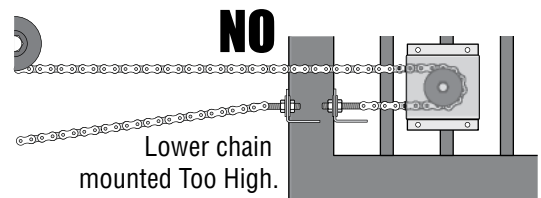
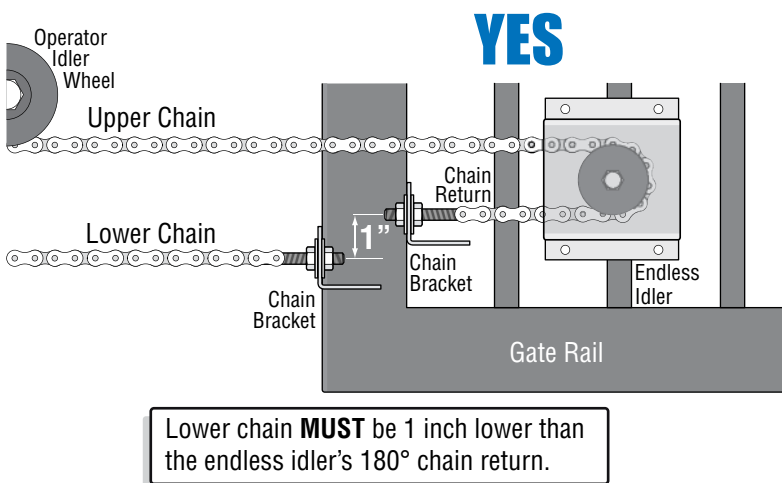

## Rear Mount Position (Side View)

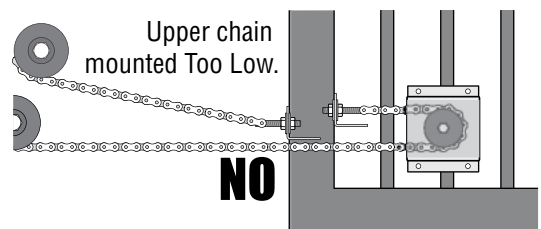
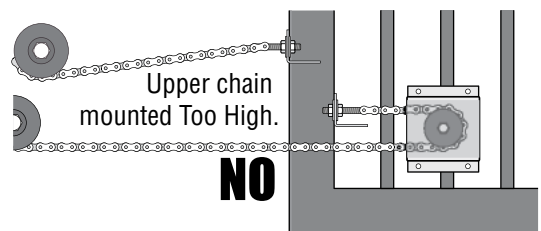
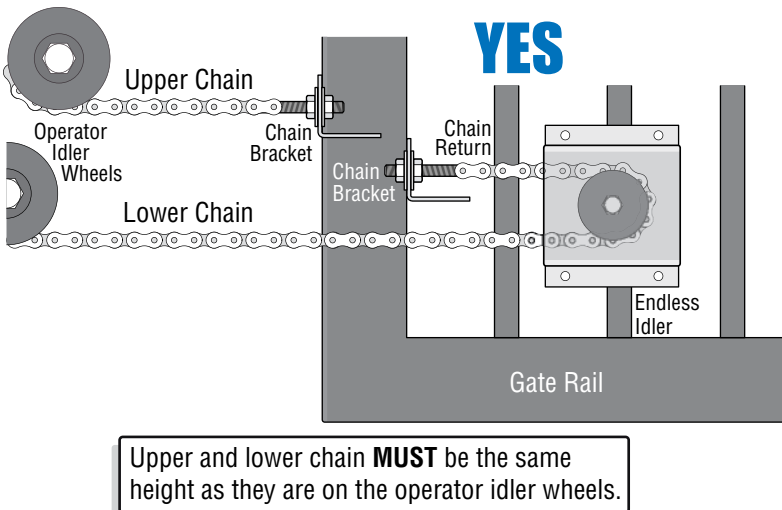

## 1.11 DoorKing's Chain Tray Kit

A chain tray is recommended for gates longer than 20 ft. to support the weight of the chain. DoorKing offers a chain tray kit in 10 ft. sections to fit any length gate. (DoorKing P/N 2601-270 10 Ft. section)

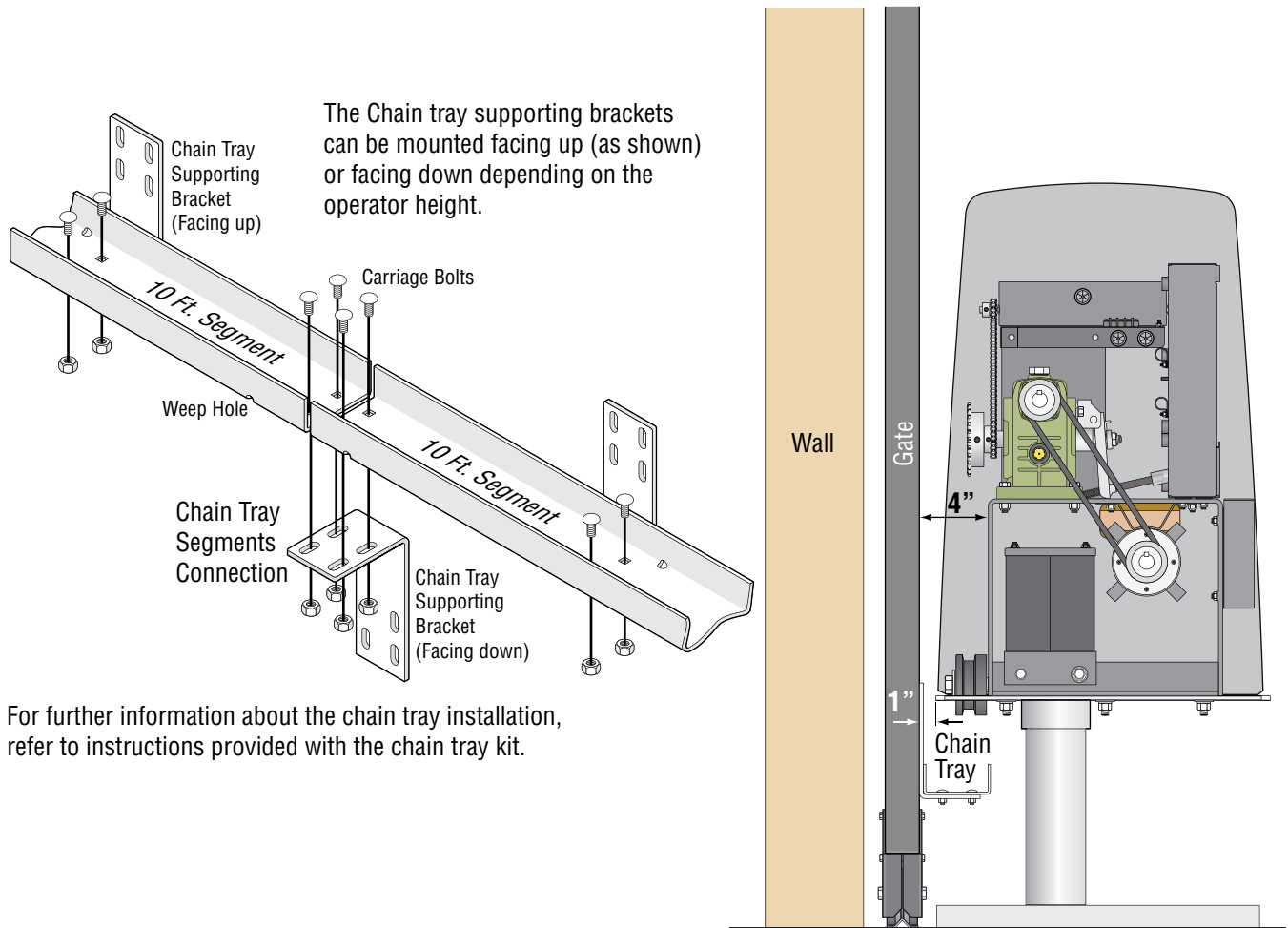

For further information about the chain tray installation, refer to instructions provided with the chain tray kit.

## 1.12 Installation of Warning Signs

This DoorKing Slide Gate Operator is shipped with two warning signs. The purpose of the warning sign is to alert uninformed persons, and to remind persons familiar with the gate system, that a possible hazard exists so that appropriate action can be taken to avoid the hazard or to reduce exposure to the hazard. See page 3 for suggested mounting positions of signs.

- **Warning signs are to be permanently installed in the area of the gate in such a manner that at least one warning sign is visible by persons located on each side of the gate, for both the secure and unsecure sides of the gate.**
- Use appropriate hardware such as wood or sheet metal screws (not supplied) to install the warning signs.



# SECTION 2 - SOLAR INPUT POWER TO OPERATOR

Before connecting the solar panel wire to the operator, make sure that the solar panel is blocked from the sunlight.

**The solar panel is "HOT" (discharging power) whenever the sun is shining on it. It will shock you if you attempt to touch the wires while it is in the sunlight!**

Permanent wiring must be installed to the operator as required by local electrical codes. It is recommended that a licensed electrical contractor perform this work.

**Since building codes vary from city to city, we highly recommend that you check with your local building department prior to installing any permanent wiring to be sure that all wiring to the operator (both high and low voltage) complies with local code requirements.**

**THIS GATE OPERATOR MUST BE PROPERLY GROUNDED!!**

## 2.1 Solar Power Connections

Connect **ONLY 24 VDC** power. DoorKing Solar Power Kit P/N 2000-070 is recommended. Third party **24 VDC batteries and solar panel** can be used if desired.

The solar panel will perform **MOST** efficient when installed as close as possible to the operator (Within a couple of feet). Keep in mind, the efficiency of the solar panel will diminish the farther away the panel is installed from the operator.

- **DO NOT** install a heater kit when using solar power.

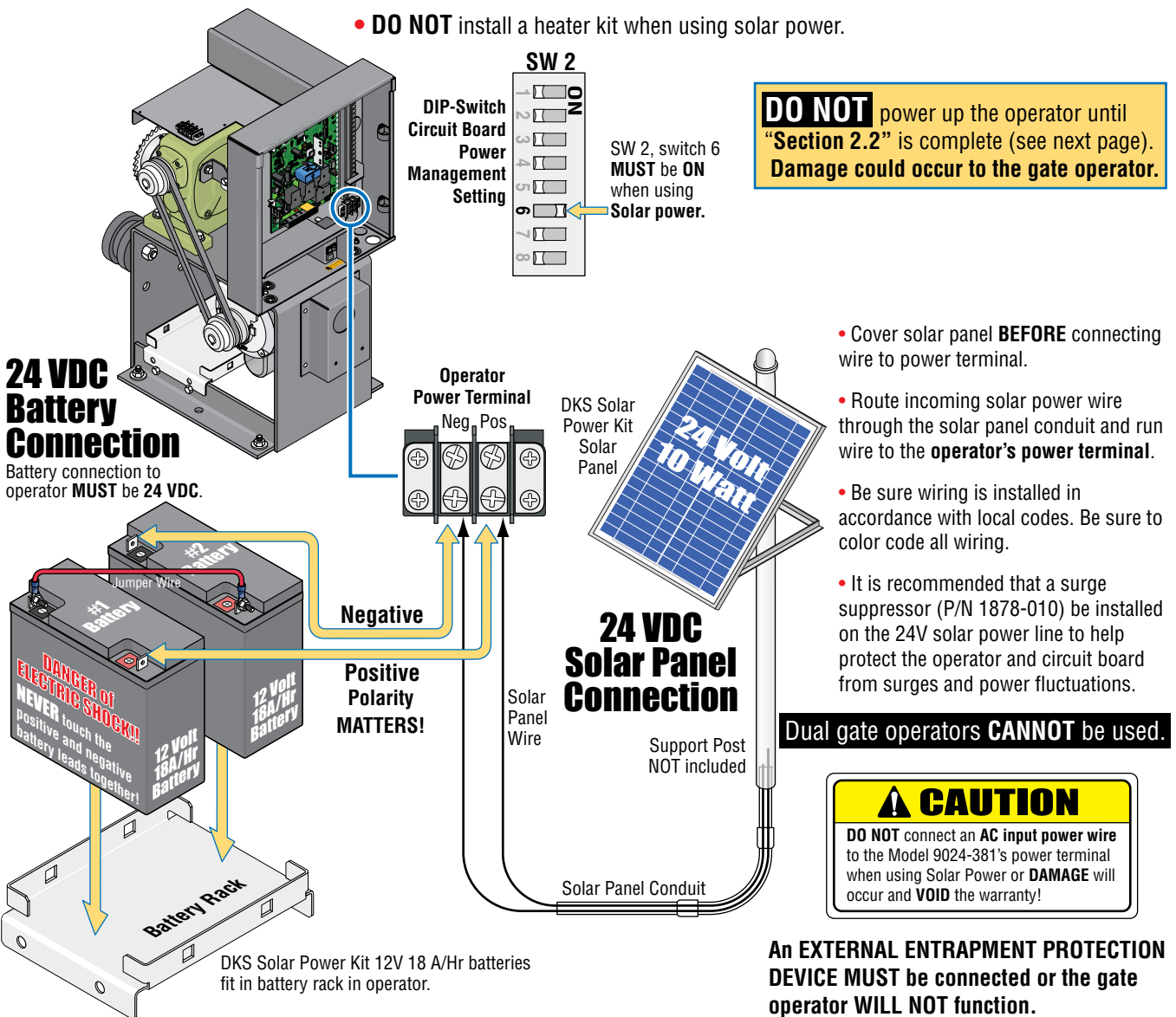

## 2.2 Power Select Jumper and Turning Power ON

The “POWER SEL” jumper on the circuit board **MUST** be set correctly or operator will not function correctly.

**DO NOT** cycle the operator until the “DIP-Switches” and the “Limit Switches” have been adjusted. **Damage could occur to the gate and gate operator.** See pages 22-24.

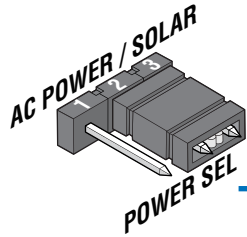

### POWER SEL Jumper

**Important:** Pins 2 and 3 **MUST** be jumpered together when using solar input power to **manage power drain** from circuit board.

**DO NOT** jumper pins 1 and 2 together or circuit board will not manage power and **continually draw FULL power** from the batteries.

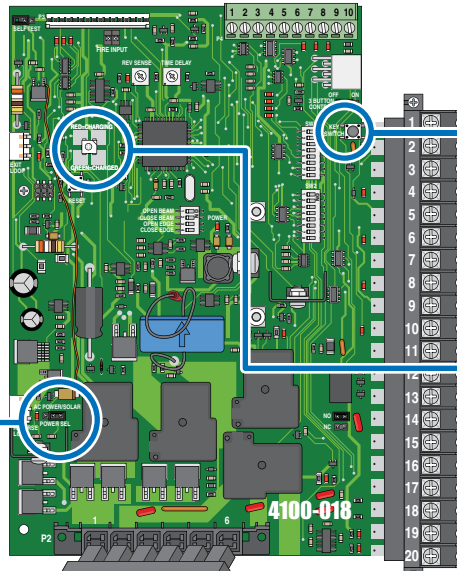

### Battery Plug P2

#### Important Battery Plug Note:

Battery Plug P2 comes from the factory unplugged and needs to be plugged into circuit board when operator is ready to be powered up.

To power up operator: turn DC power switch **ON**. Press **KEY SWITCH** and LEDs will light up on circuit board.

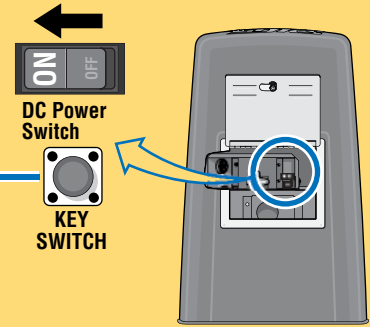

RED=CHARGING

### Battery Charging LED Monitor

GREEN=CHARGED

This may be red when first powering up operator depending on how much of a charge the batteries have.

## Power Management of Circuit Board

The operator manages the power drain of the circuit board by powering down unused inputs on the board when the operator is idle. When the gate has been closed for 1 min. or held open for 5 min., the circuit board powers down unused inputs to conserve power drain. **Main terminals 1, 2 and 3 NEVER power down.** Any activation from one of these inputs will power up the circuit board when it is in the powered down mode (idle time). **It is important to have LOW CURRENT DRAW devices connected to terminal 3 or operator performance will be significantly reduced!**

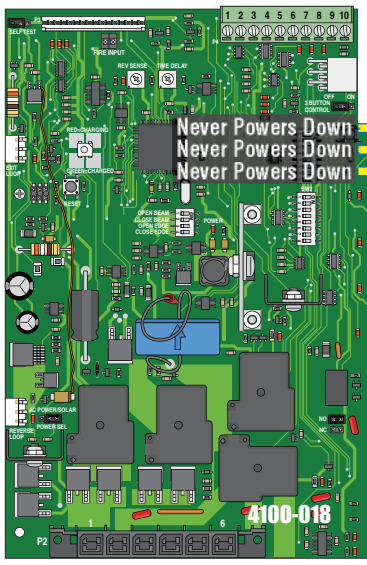

**IMPORTANT:** ANY access control device connected to terminals 1, 2 & 3 needs to have a relay contact time of **AT LEAST 1 SECOND** to bring the circuit board out of “idle time” and operate gate.

### 3-Pin Remote Terminal

Power is limited to 250 mA

**Radio Receiver:** DoorKing's 3-wire radio receiver is specifically designed to be connected to a solar powered gate operator. If using a third party radio receiver, it **MUST** be a low current draw radio receiver type. See page 26 for wiring information.

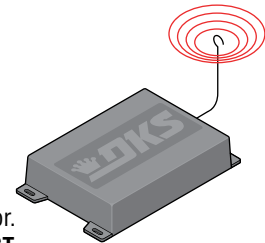

**EXIT Loop Detector:** Power for an external EXIT loop detector. It **MUST** be a low current draw type detector. See page 30 for wiring information.

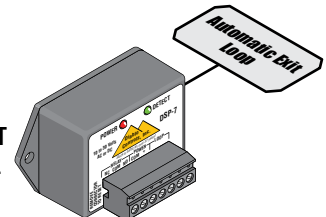



# SECTION 3 - ADJUSTMENTS

The switch settings and adjustments in this chapter should be made after your installation and wiring to the operator(s) is complete. **Whenever any of the programming DIP-switches on the circuit board are changed, reset button MUST be pressed before the new setting will take effect.**

## 3.1 4100 Circuit Board Descriptions and Adjustments

### How LEDs Function



Illuminated LEDs indicates that low voltage power is being applied to the circuit board.

**Input LEDs** should be OFF and will only illuminate when the input that is next to the LED is activated. See page 31.  
**Limit LEDs** will only illuminate when the respective limit switch has been activated.

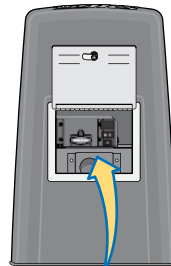

**DC Power Switch**  
**Note:** Alarm reset button **WILL NOT** reset circuit board after changing DIP-switch settings.

### Reverse Sensor

Adjust reversing sensitivity for the open **AND** close direction of the operator. See page 25.

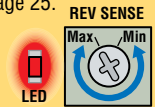

### Auto-Close Timer

Auto-close timer (when turned on) SW 1, switch 2.



### Time Delay:

Adjust from 1 second (full counter-clockwise) to approximately 23 seconds (full clockwise).



**Key Switch:** Cycles the operator when pressed. Will use Auto-Close timer when turned ON.



**Note:** When powering up operator, the key switch **MUST** be pressed **AFTER** DC power switch is turned ON to power up operator.

### DIP-Switches

Set the DIP-switches on the circuit board to the desired setting. See switch-settings on next 2 pages.

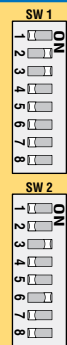

**Reset Button:** Press after changing a DIP-switch setting on the board or if board locks up during operation.



### Board Relay

Dry relay contacts (terminals 13-14) can be set for Normally Open (NO) or Normally Closed (NC) operation by placing the relay shorting bar on the N.O. or N.C. pins respectively. SW 1, switches 6 and 7 must be set to control relay. See next page for descriptions.

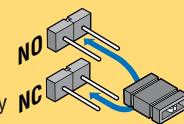

### Fire Dept Open

Connect **ONLY** emergency access controls accessible by authorized personnel (e.g., fire, police, EMS). Upon activation, alarm will sound and the operator will go into a hard shutdown after reaching the open limit. Operator must be reset to resume normal operation. See pages 32, 34.

### Limit/Alarm Plug P3 Terminal

### Self-Test



### Self-Test Mode

Self-test mode is for bench checks **ONLY!** Operator **MUST** be disconnected from the gate. The operator will continually cycle the gate.



### Normal Mode

The jumper must be set at normal mode for normal operator function.

### 10-Pin UL 325 Removable Terminal

See pages 26-28.

### Plug-In Low Current Draw Loop Detectors

See page 29, sold separately

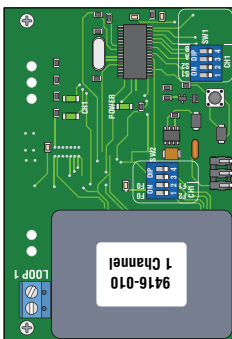
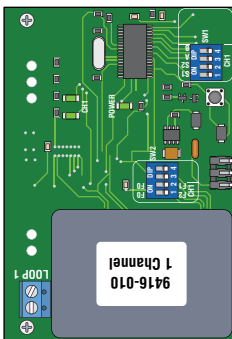

### External Low Current Draw Loop Detectors

See page 30 and instruction sheet that comes with loop detector for more information.

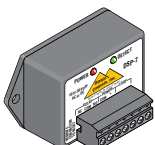

### Battery Plug P2 Terminal

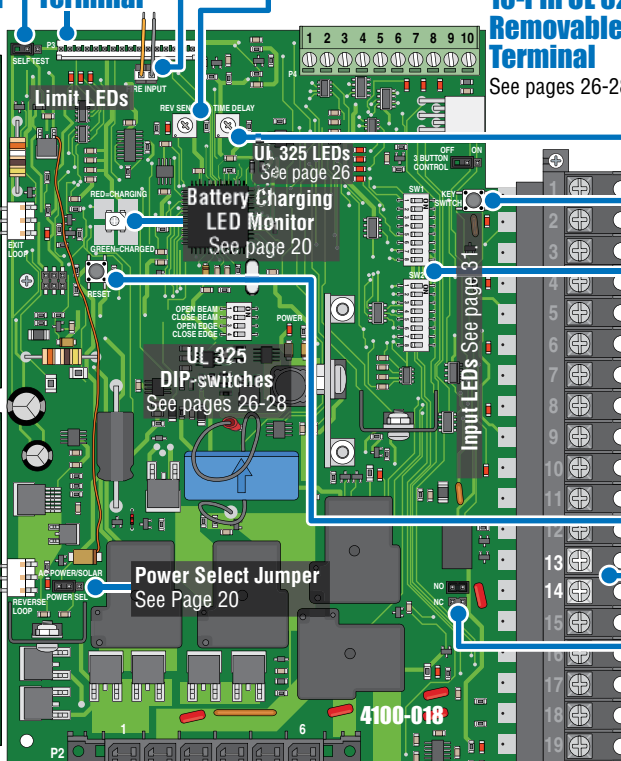

### 20-Pin Main Terminal

See pages 31 and 32.



## 3.2 DIP-Switch Settings for 4100 Circuit Board

The two DIP-switches located on the circuit board are used to program the operator to operate in various modes and to turn on or off various operating features. Whenever a switch setting is changed, reset button must be pressed for the new setting to take affect. See next page for more information about DIP-switches.

SW 1 (Top 8 DIP Switches)			
Switch	Function	Setting	Description
1	Operator Opening Direction	Opening direction using <b>ON</b> setting.  Opening direction using <b>OFF</b> setting. 	Changes direction operator will cycle open upon initial AC power up and open command.
2	Auto-Close Timer	OFF	Auto-close timer is <b>OFF</b> . Manual input required to close an open gate.
		ON	<b>Normal Setting.</b> Auto-close timer is <b>ON</b> . Adjustable from 1-23 seconds.
3	Not Used	<b>OFF</b>	Switch <b>MUST</b> be turned <b>OFF</b> for Solar.
4	Reverses Gate	OFF	<b>Normal Setting.</b> Input to main terminal 10 and reverse loop will <b>reverse</b> gate during <b>close</b> cycle.
	Stops Gate (Slide gates)	ON	Input to main terminal 10 and/or reverse loop will <b>stop</b> gate during <b>close</b> cycle – gate will <b>continue to close</b> after input to main terminal 10 and/or reverse loop are cleared (Helps prevent tailgating).
5	Quick-Close Timer Override (Slide gates)	OFF	<b>Normal Setting.</b> Quick close feature is <b>OFF</b> . Auto-Close timer functions normally.
		ON	Quick close feature is <b>ON</b> . Opening gate will stop and close as soon as all reversing inputs (Reverse loops, photo sensors) are cleared regardless of the distance the gate has opened. Any Auto-Close timer setting overrides to 1 sec.
6 and 7	Relay: Main Terminals 13 and 14	6-OFF 7-OFF	<b>Normal Setting.</b> Relay activates when gate is at open limit.
		6-OFF 7-ON	Relay activates when gate is not closed.
		6-ON 7-OFF	Relay activates when gate is opening and open.
		6-ON 7-ON	Relay activates during opening and closing cycle.
8	Accessory Power	OFF	24 VDC 500 mA <b>accessory power</b> for accessories connected to main terminal 12.
		ON	<b>DO NOT USE</b> for Solar.

 Setting **MUST** be used

SW 2 (Bottom 8 DIP Switches)			
Switch	Function	Setting	Description
1 and 2	Select Operator Type	<b>1-OFF 2-OFF</b>	<b>Slide Gate Operator</b>
		1-OFF 2-ON	<b>DO NOT USE</b> for the 9024. Swing Gate Operator
		1-ON 2-OFF	<b>DO NOT USE</b> for the 9024. Barrier Gate Operator
		1-ON 2-ON	<b>DO NOT USE</b> for the 9024. Overhead Gate Operator
3	Input Power Failure Mode	OFF	<b>DO NOT USE</b> for Solar.
		ON	Gate <b>operates normally</b> until batteries get low. Gate will <b>CLOSE and Shutdown operator</b> in close position until battery power reaches an operable level again.
4	Reverse/Shadow Input	OFF	Main terminal 10 is a REVERSE input.
		ON	<b>DO NOT USE</b> for the 9024. Main terminal 10 is a SHADOW loop (Swing gates ONLY)
5	Overlapping Dual Gates	OFF	Switch 5 <b>MUST</b> be turned <b>OFF</b> for the 9024.
		ON	<b>DO NOT USE</b> for the 9024. Overlapping gates <b>ARE</b> used (Dual swing gates ONLY). Secondary gate starts to open a few seconds before primary gate starts.
6	Circuit Board Power Management	OFF	<b>DO NOT USE</b> for Solar. For 115/230 VAC input power. Board has <b>Constant power</b> .
		ON	Used for <b>Solar</b> input power. Board <b>Minimizes power</b> when not in use. All terminals shut down power except <b>main terminals 1, 2 and 3</b> .
7 and 8	Not Used	OFF	Switches 7 and 8 <b>MUST</b> be turned <b>OFF</b> for the 9024.

## 3.2 DIP-Switches Continued

### SW-1 Switch

(Top 8 switches on circuit board)

Typical Settings	SW 1
Opening - RT/LT	<input type="checkbox"/> NO
Normal - ON	<input type="checkbox"/> NO
<b>MUST use - OFF</b>	<input type="checkbox"/> NO
Normal - OFF	<input type="checkbox"/> NO
Normal - OFF	<input type="checkbox"/> NO
Normal - OFF	<input type="checkbox"/> NO
Normal - OFF	<input type="checkbox"/> NO
<b>MUST use - OFF</b>	<input type="checkbox"/> NO

**Switch 1 - Operator Opening Direction:** **Must OPEN** the operator's gate upon initial AC power up and open command. If the first open command begins to close the gate, turn AC power off and reverse this switch.

**Switch 2 - Auto-Close Timer:** Turns the auto-close timer on or off. If auto-close is ON, maximum time that can be set for is approximately 23 secs. If auto-close is OFF, an open gate will not close until a manual input is received.

**Switch 3 - EXIT Loop Port Output / Full Open Input:** This switch **MUST** be turned **OFF** when using solar power. **DO NOT** turn this switch ON. **DO NOT** wire any devices to main terminal 4.

**Switch 4 - Reverse / Stop Gate:** Determines if an input to main terminal 10 (Photo Sensors) **AND/OR** reverse loops will reverse **OR** stop a **CLOSING** gate.

A tailgating vehicle **can activate** main terminal 10 (Photo sensors) and/or reverse loops **while** the gate is in the closing cycle from the previous vehicle's authorized entry:

If switch 4 is turned **OFF** (Reverse), the closing gate that gets activated by a tailgating vehicle will reverse back to the open position, possibly allowing the tailgating vehicle **unauthorized entry while the gate is reversing back to the open position.**

If switch 4 is turned **ON** (Stop), the closing slide gate that gets activated by a tailgating vehicle will stop, partially or completely blocking the pathway, **NOT** allowing the tailgating vehicle to enter without proper authorization. The slide gate will not move until all sensors are clear, usually forcing the tailgating vehicle that activated the sensors to back away from the gate. The slide gate will then continue until closed, helping prevent the tailgating vehicle from unauthorized entry.

**Switch 5 - Quick-Close Timer Override:** Turning the quick-close feature ON will cause an **opening gate** to stop and close when the reverse loops and/or photo sensors have been cleared by a vehicle no matter how far the gate has opened (Useful when opening a long gate to reduce gate cycling time). This will also override the auto-close timer setting to close the gate after 1 second, regardless of the time that has been set for the auto-close timer.

**Switches 6-7 - Relay:** These work in conjunction with each other and determine when the relay on the board (main terminals 13-14) will be activated. This relay can be used as a switch for various functions such as illuminating a warning light when the gate is moving, or turning on a green light when the gate is full open.

**Switch 8 - Accessory Power:** This switch **MUST** be turned **OFF** when using solar power. A maximum of 500 mA of accessory power is supplied to any accessory connected to main terminal 12. Power to terminal 12 is **ONLY** available when the gate is opening, open, or closing. Power is **OFF** when the gate is closed. **DO NOT** turn this switch ON.

### SW-2 Switch

(Bottom 8 switches on circuit board)

Typical Settings	SW 2
<b>MUST use - OFF</b>	<input type="checkbox"/> NO
<b>MUST use - OFF</b>	<input type="checkbox"/> NO
<b>MUST use - ON</b>	<input type="checkbox"/> NO
<b>MUST use - OFF</b>	<input type="checkbox"/> NO
<b>MUST use - OFF</b>	<input type="checkbox"/> NO
<b>MUST use - ON</b>	<input type="checkbox"/> NO
<b>MUST use - OFF</b>	<input type="checkbox"/> NO
<b>MUST use - OFF</b>	<input type="checkbox"/> NO

**Switches 1-2 - Select Operator Type:** These switches **MUST** be turned **OFF** for the Model 9024. They indicate the type operator that will be used with the circuit board.

**Switch 3 - Input Power Failure Mode:** This switch **MUST** be turned **ON** when using solar power. In the event that the solar panel cannot charge the batteries and battery power gets depleted through normal gate cycling, gate will **CLOSE** and operator will shut down. When solar panel power begins charging the batteries and they reach an operable level, the gate will resume normal operation.

**DO NOT** turn this switch OFF.

**Switch 4 - Reverse Input:** This switch **MUST** be turned **OFF** for the 9024. Main terminal 10 is a reverse input. **DO NOT** turn ON.

**Switch 5 - Overlapping Dual Gates:** This switch **MUST** be turned **OFF** for the 9024. **DO NOT** turn ON for the 9024.

**Switch 6 - Circuit Board Power Management:** This switch **MUST** be turned **ON** when using solar power. It minimizes the power drain by the circuit board. When the gate has been closed for 5 min. or held open for 5 min., circuit board will power down to conserve power. Main terminals 1, 2 and 3 will remain powered up. An input from one of these connections will power up the circuit board again.

**DO NOT** turn ON when using solar power.

**Switches 7-8 - Not Used:** These switches **MUST** be turned **OFF** for the Model 9024. **DO NOT** turn ON.

## 3.3 Limit Switches

### Open and Close Limits **MUST** be Set

The operator normally stops a cycling gate using the open and close limits. If the limits have not been set, the gate could continue beyond its full open and close positions, damaging the gate and operator. **DO NOT** allow this to occur!

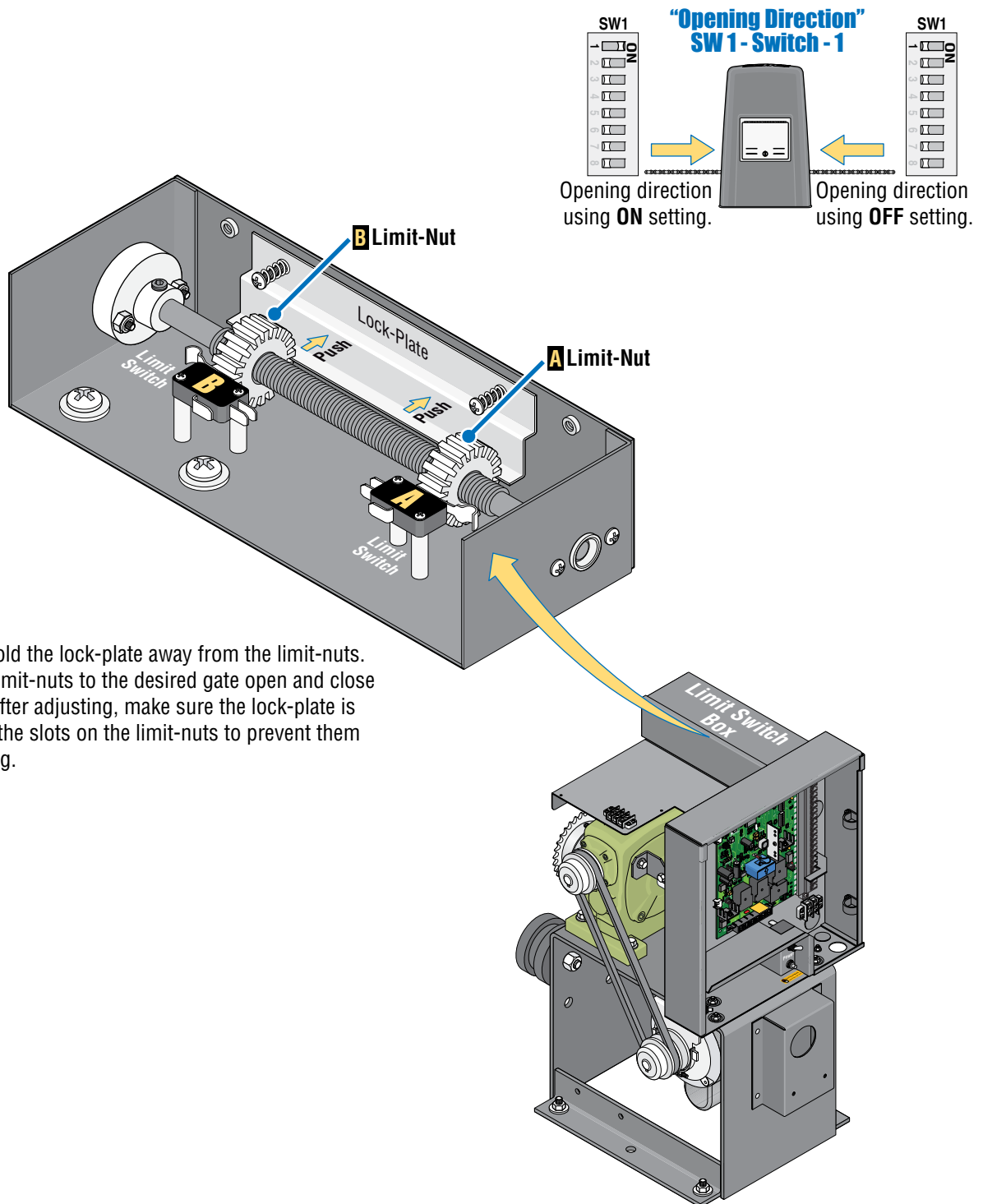

Push and hold the lock-plate away from the limit-nuts. Rotate the limit-nuts to the desired gate open and close positions. After adjusting, make sure the lock-plate is engaged in the slots on the limit-nuts to prevent them from rotating.

**Note:** Limit/Alarm Plug P3 **MUST** be connected to the circuit board or operator will **NOT** function.

## 3.4 Inherent Reverse Sensor Adjustment

This vehicular gate operator is equipped with an inherent adjustable reversing sensor (Type A) used as entrapment protection according to UL 325 standards. **The gate will reverse direction after “physically” encountering an obstruction in either the opening or closing gate cycle.**

If the Auto-Close Timer (DIP-switch SW 1, switch 2) is ON and the gate physically encounters an obstruction during the **CLOSING** cycle, it will reverse to the open position and **HOLD** the gate at this position (Soft shutdown condition). Another input command is needed before the gate will reset and close again.

For the reverse system to function correctly, the gate must be properly installed and work freely in both directions and the limit switches must be properly adjusted before adjusting these sensors. The ideal adjustment will allow the operator to move the gate through its entire travel cycle without reversing, but will reverse upon contact with an obstruction with no more than 40 Lbs of force. This force can be measured with a gate scale.

**CAUTION: Keep pedestrians and vehicles clear of the gate while adjusting and testing sensors!**

- 1 Press the “**Push to Operate**” button to **OPEN** the gate.

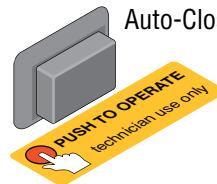

Note: “**Push to Operate**” button will use Auto-Close timer if turned ON.

- 2 While gate is opening, slowly rotate the reverse sensor clockwise until the LED lights up and the gate reverses direction. Rotate the reverse sensor back counter-clockwise approximately 1/8 turn to decrease the sensitivity (LED will turn off).

Note: The LED will turn on briefly when AC power is turned on.

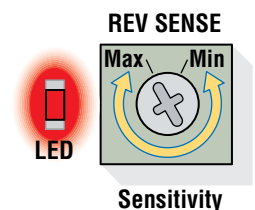

- 3 Press the “**Push to Operate**” button and **CLOSE** the gate. Make sure the gate closes completely. If it reverses and opens (LED will turn on), rotate the reverse sensor counter-clockwise a little more to decrease the reverse sensitivity (LED will turn off).

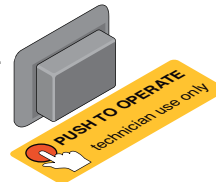

Cycle the gate a few times to be sure that it cycles completely in both directions, adjusting the sensor as necessary.

**Safety Note:** The LED will remain ON after a cycling gate gets obstructed during normal operation to indicate that the reverse sensor has been tripped. Always check the gate area for possible obstructions before putting operator back in service.

### Test the operator reversing sensitivity:

Place an immobile object along the gate path, allowing the gate to strike it while in the **open** and **close** cycles. The gate must reverse direction after striking the object. If it does not, increase the reverse sensitivity and repeat this testing until the correct sensitivity has been achieved in **BOTH** directions. The operator will assume a soft shutdown (Hold the auto-close timer) after striking and reversing the gate which will require pressing the “**Push to Operate**” button to cycle the operator again.

# SECTION 4 - ENTRAPMENT AND SAFETY PROTECTION

## External Entrapment Protection Devices:

In addition to the inherent reversing sensor system, this operator has a UL 325 terminal for the connection of **photo sensors**-Type B1 and/or **reversing edges**-Type B2 entrapment protection required by UL 325 standards. Install these devices where the risk of entrapment or a safety hazard exists, examples of which are shown below and the next 2 pages. Installations can vary.

**Entrapment Protection must be provided for the gate system where the risk of entrapment or obstruction exists. The operator will NOT run without ONE or more monitored type B1 or B2 external entrapment protection devices installed in EACH direction of gate travel (minimum of 2 external devices required).**

## 4.1 UL 325 Description

### UL 325 Terminal

Connect **ONLY MONITORED** Devices

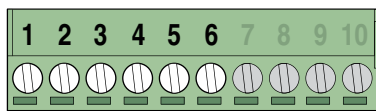

- 1 OPEN Beam (Switch 1)
- 2 CLOSE Beam (Switch 2)
- 3 OPEN Edge (Switch 3)
- 4 CLOSE Edge (Switch 4)
- 5 Ground (Common)
- 6 Ground (Common)
- 7
- 8
- 9
- 10

Only 1 monitored Device can be connected to each input. An **OPTIONAL** Expansion Kit (sold separately) will allow connection for additional devices.

DIP-switches **MUST** be turned **ON** for each device wired to terminal.

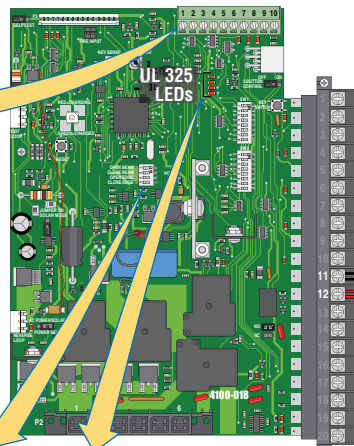
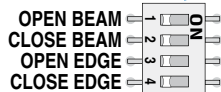

### Photo Sensors POWER:

Terminal 12 supplies 24 VDC, 500 mA of power for desired accessories.

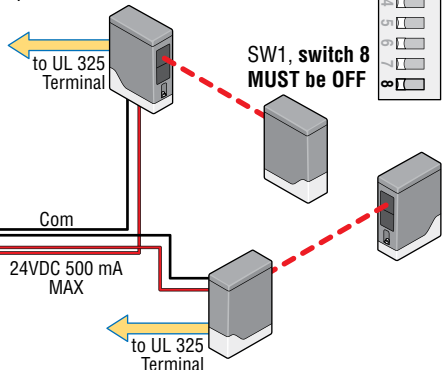

**FLASHING LED** indicates an open circuit (no entrapment device is connected).  
**STEADY ON LED** indicates there is a short across the input.

## Device Terminal Number/Function and General Location

- 1 OPEN Beam:** Obstructed opening-direction photo beam will stop the gate **during the opening-direction only**. Gate will resume the open cycle when the obstructed photo beam has been cleared.
- 2 CLOSE Beam:** Obstructed closing-direction photo beam will reverse the gate to the open position and reset the close-timer **during the closing-direction only**. Gate will close when timer times out.
- 3 OPEN Edge:** Obstructed reversing edge will reverse the gate to the close position **during the opening-direction only**.
  - After the gate reverses to the close position, any opening input will cycle the gate again.
  - Note:** If the gate is opening by a time clock and the edge gets obstructed, the gate will return to the closed position and another input (automatic exit loop, reverse loop, remote etc.) is needed to cycle the gate open again.
- 4 CLOSE Edge:** Obstructed reversing edge will reverse the gate to the open position **during the closing-direction only**.
  - After the gate reverses to the open position, the close-timer will time out and close the gate (if it is turned on).
  - If a second sequential obstruction is encountered prior to the gate reaching the close limit, the gate will **reverse to full open position** and enter a soft shutdown condition (See page 34).
- 5 & 6 Ground (Common):** Common terminals for all the external entrapment protection device inputs.

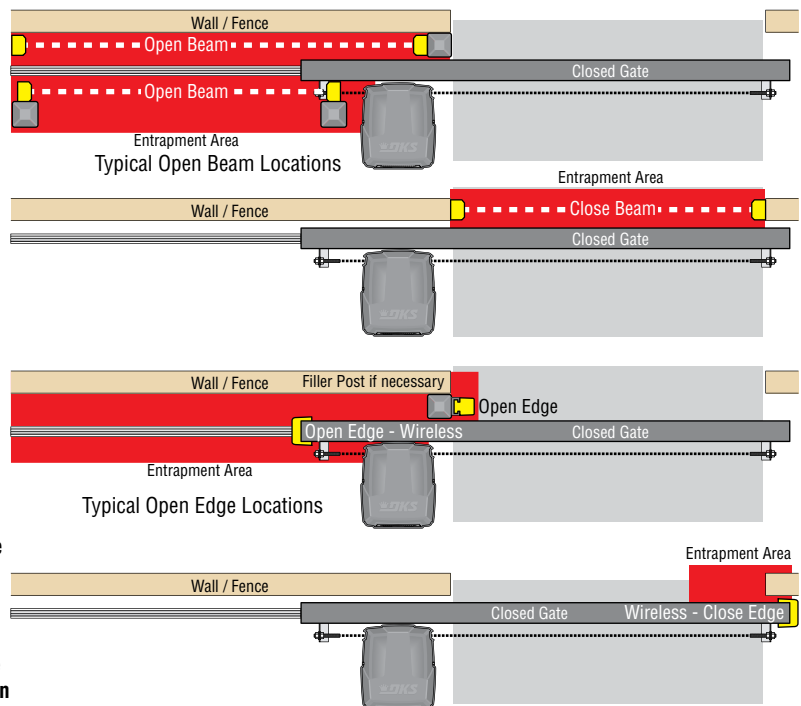

# 4.2 External Entrapment Protection Device Locations

## Typical UL Photo Sensor mounting height and distance away from gate.

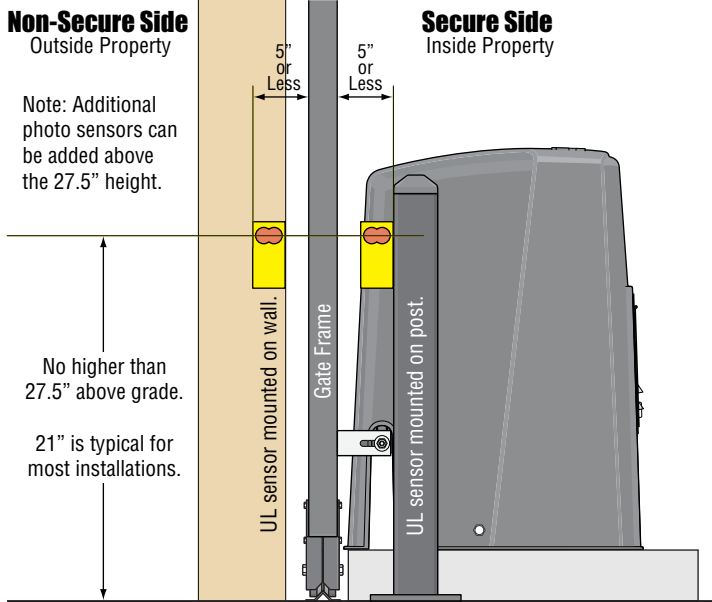
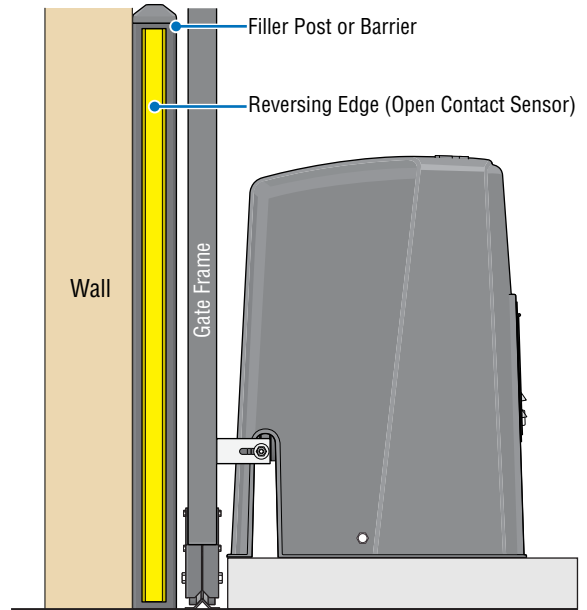

Photo sensors may be installed on either side of gate frame, as close as practical to the gate but no further away than 5".

## If the distance between the gate and wall is greater than 2 1/4".



A filler post or barrier may need to be installed between the gate and wall area to reduce the distance to 2 1/4" or less. A reversing edge should be installed on the post or barrier for safety (See page 2 for more information).

## Photo Sensors (With Filler Post and Reverse Edge) Sample Setup

Entrapment Protection must be provided for the gate system where the risk of entrapment or obstruction exists. The operator will NOT run without ONE or more monitored type B1 or B2 external entrapment protection devices in EACH direction of gate travel (minimum of 2 external devices required).

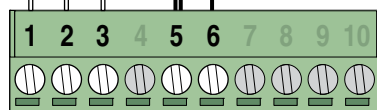
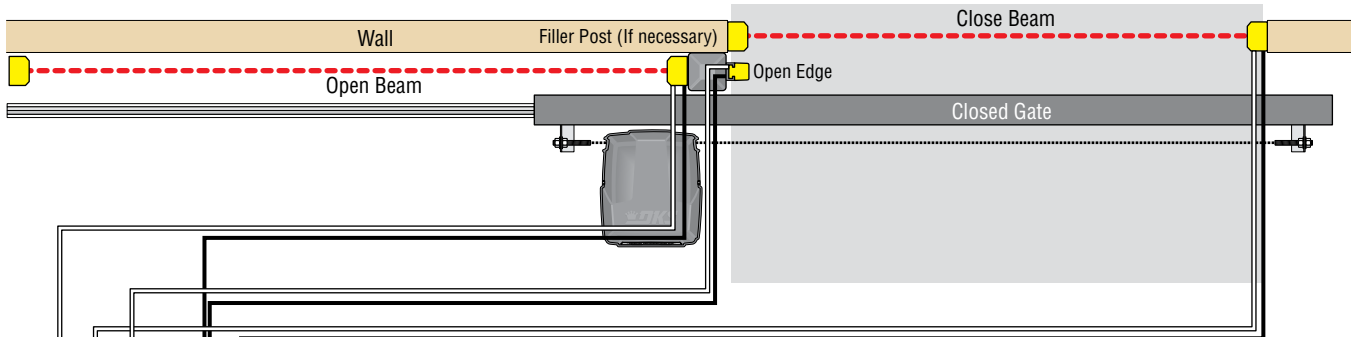

**UL 325 Terminal Wiring**  
Connect ONLY MONITORED devices to UL 325 terminal.

OPEN BEAM (Switch 1)  
CLOSE BEAM (Switch 2)  
OPEN EDGE (Switch 3)  
CLOSE EDGE (Switch 4)  
Ground (Common)  
Ground (Common)

OPEN BEAM  
CLOSE BEAM  
OPEN EDGE  
CLOSE EDGE

DIP-switches 1, 2 and 3 MUST be ON.

Only 1 monitored Device can be connected to each input. An **OPTIONAL** Expansion Kit (sold separately) will allow connection for additional devices.

**Type of wiring to be used on ALL external devices:**  
A) Type CL2, CL2P, CL2R, or CL2X.  
B) Other cable with equivalent or better electrical, mechanical, and flammability ratings.

**IMPORTANT:** Monitored Photo and Edge sensors must be end-of-line resistive types. See specific manufacturer's wiring manual for more information.

**Photo Sensor Power Note:** Photo sensor power can be provided by circuit board (See previous page).

# Wireless Reverse Edge Sample Setup - Single Receiver

Entrapment Protection must be provided for the gate system where the risk of entrapment or obstruction exists. The operator will NOT run without ONE or more monitored type B1 or B2 external entrapment protection devices in EACH direction of gate travel (minimum of 2 external devices required).

**IMPORTANT:** Monitored Photo and Edge sensors must be end-of-line resistive types. See specific manufacturer's wiring manual for more information.

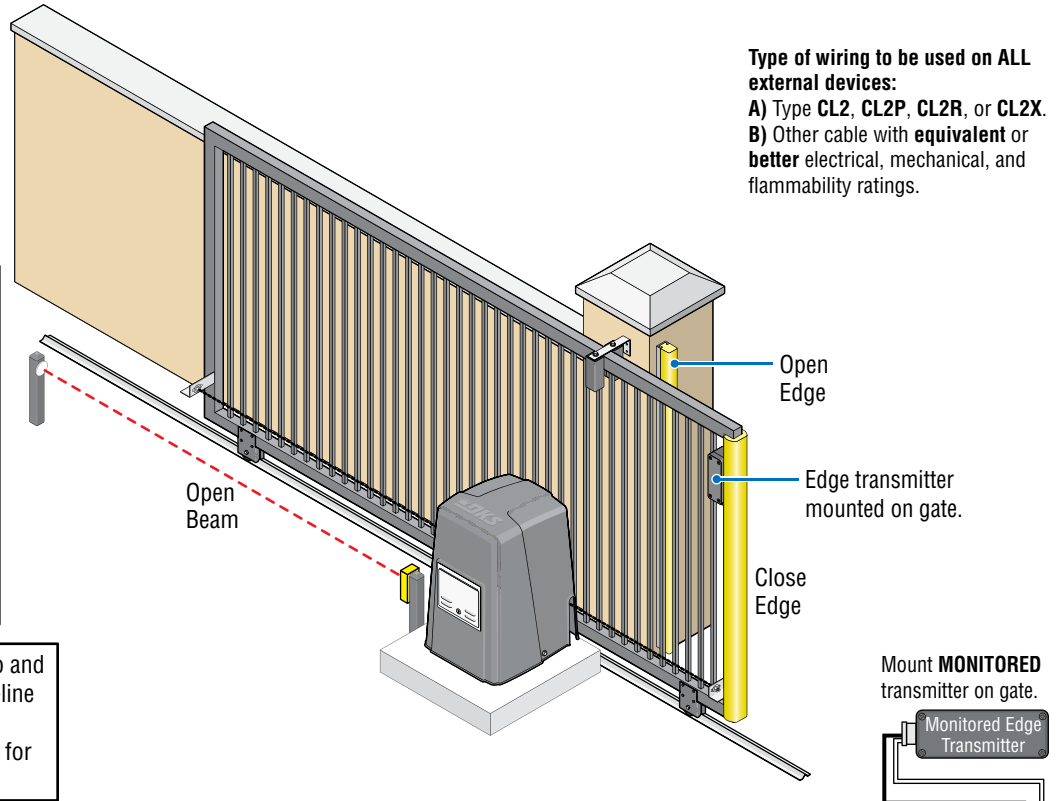

Type of wiring to be used on ALL external devices:  
**A)** Type CL2, CL2P, CL2R, or CL2X.  
**B)** Other cable with equivalent or better electrical, mechanical, and flammability ratings.

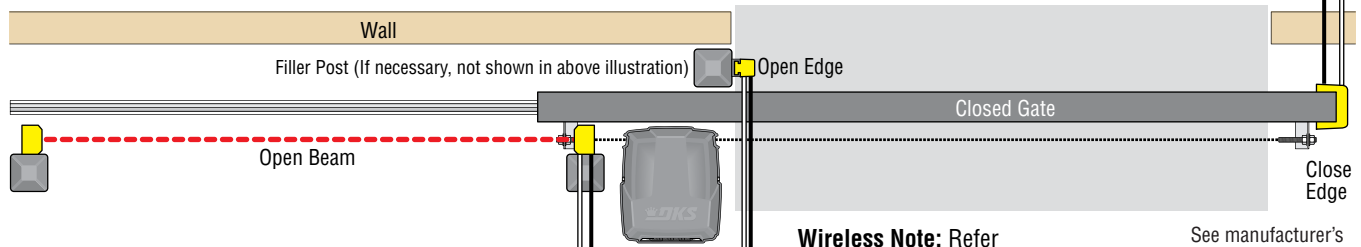

**Wireless Note:** Refer to the instruction sheet that comes with the receiver/transmitter for more specific wiring and mounting instructions.

See manufacturer's manual to "PROG" wireless edges.

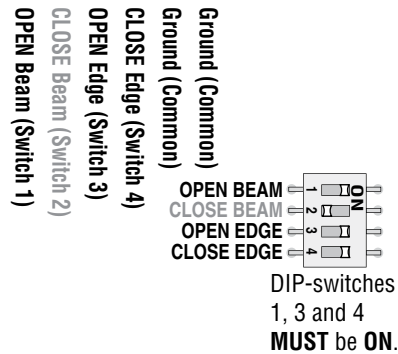
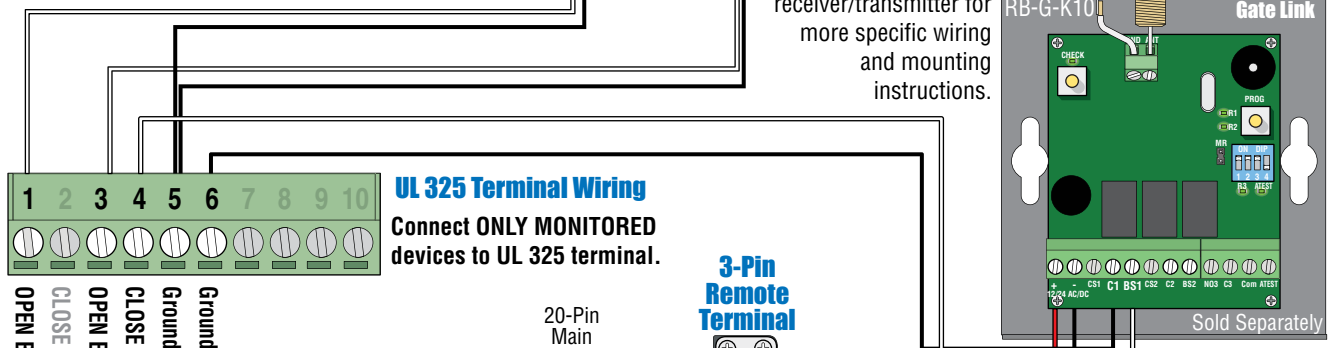

**Main Terminal #3 Note:** Exceeding 250 mA of power from this terminal may cause the circuit board transformer to overheat, causing intermittent problems.



## 4.3 Plug-In Loop Detector Wiring

To help protect the operator from accidentally closing on vehicles in the gate's path, DoorKing highly recommends that loops and loop detectors be installed. Loops are laid underneath, cut into asphalt or concrete driveways or buried beneath gravel and earth driveways. A loop detection system will sense a vehicle like a metal detector and send a signal to the gate operator preventing the gate from automatically opening or closing on a vehicle when it is in the gate's path. DoorKing recommends that a licensed installer perform this work.

DoorKing offers a free "Loop and Loop-Detectors Information Manual" PDF located at DoorKing's web site for more information. [www.doorking.com](http://www.doorking.com)

### Reverse Loops

Reverse loops are placed on each side of the gate to prevent the gate from closing on a vehicle in the gate's path. They will stop or reverse the cycling of the gate while a vehicle is in or near the gate's pathway.

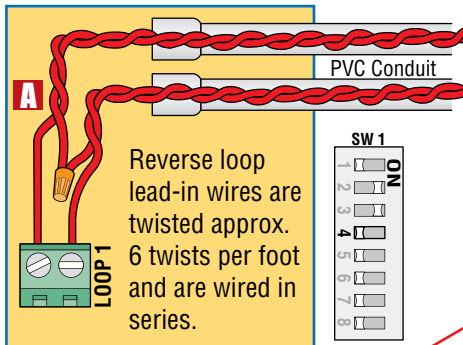

Note: SW 1, switch 4 **must** be set for the reverse loops. See pages 20 and 21 for more information about SW 1, switch 4 ON/OFF options.

### Automatic Exit Loop

Automatically opens the gate for exiting vehicles without having to use a transmitter or keypad. The exit loop can be placed a minimum of 4 feet away from the reverse loop or far enough away from the gate so the gate has started opening or even completely opened by the time you drive up to it (Free exit).

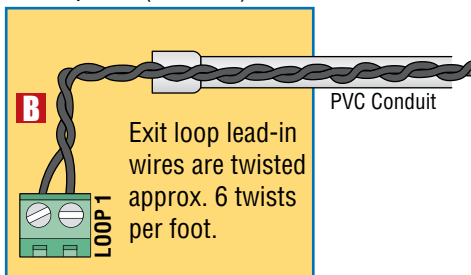

Note: Loop detector wiring is shown for DoorKing plug-in low current draw loop detector (P/N 9416-010 Single Channel). See instruction sheet to set DIP-switches on loop detectors.

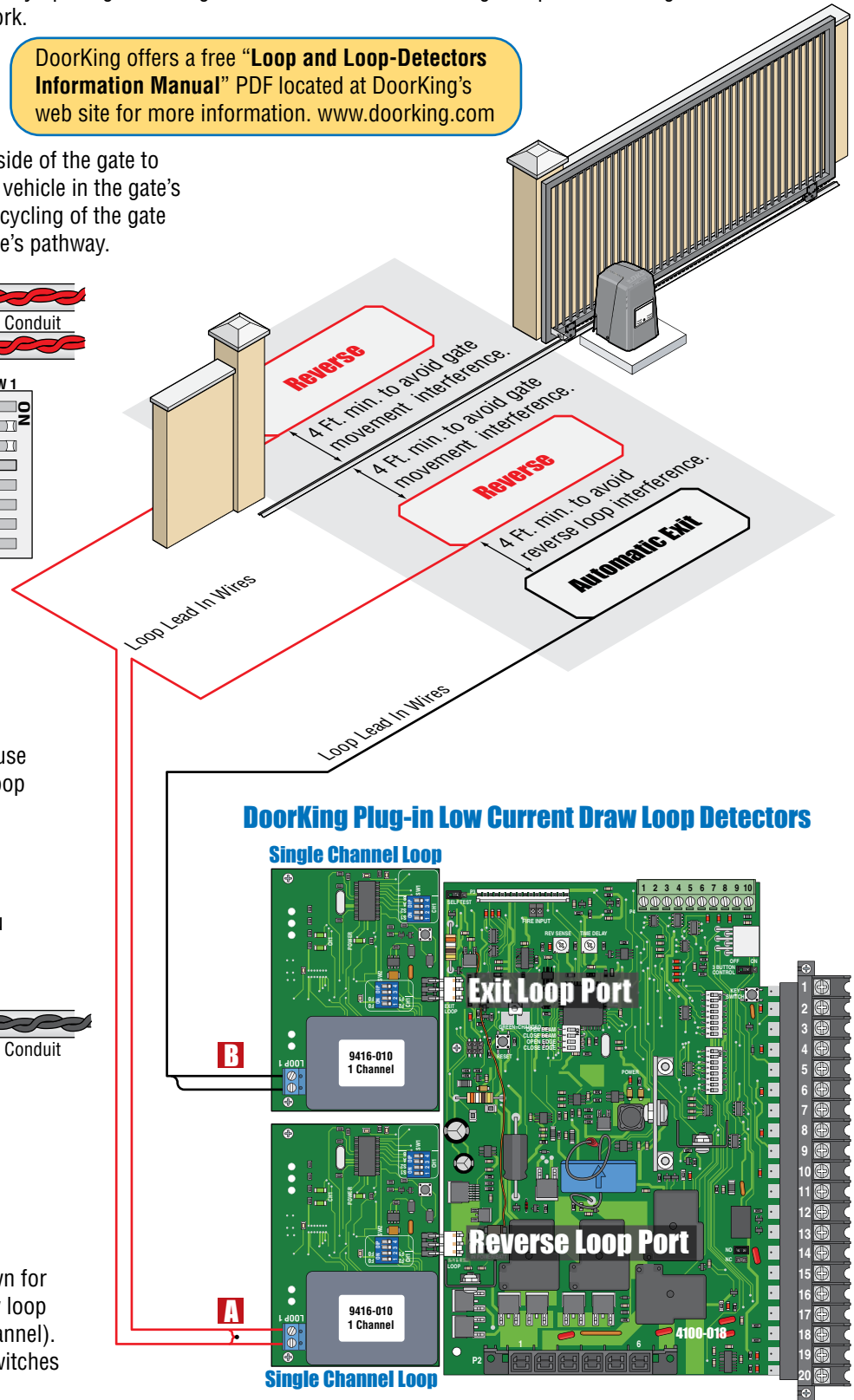

# 4.4 External Loop Detector Wiring

To help protect the operator from accidentally closing on vehicles in the gate's path, DoorKing highly recommends that loops and loop detectors be installed. Loops are laid underneath, cut into asphalt or concrete driveways or buried beneath gravel and earth driveways. A loop detection system will sense a vehicle like a metal detector and send a signal to the gate operator preventing the gate from automatically opening or closing on a vehicle when it is in the gate's path. **DoorKing recommends that a licensed installer perform this work.**

- Loop detector wiring is shown for Diablo external loop detectors. If other loop detectors are used, refer to the installation instructions supplied with those detectors for wiring instructions.
- DO NOT use EXIT or REVERSE loop ports on the circuit board
- Loop layout shown is for a typical swing gate application with two-way traffic, or one-way exit only traffic.

Type of wiring to be used on ALL external devices:

- Type CL2, CL2P, CL2R, or CL2X.
- Other cable with equivalent or better electrical, mechanical, and flammability ratings.

**IMPORTANT:** ANY loop detector used needs a relay contact time of AT LEAST 1 SECOND to bring circuit board out of "idle time" and operate gate.

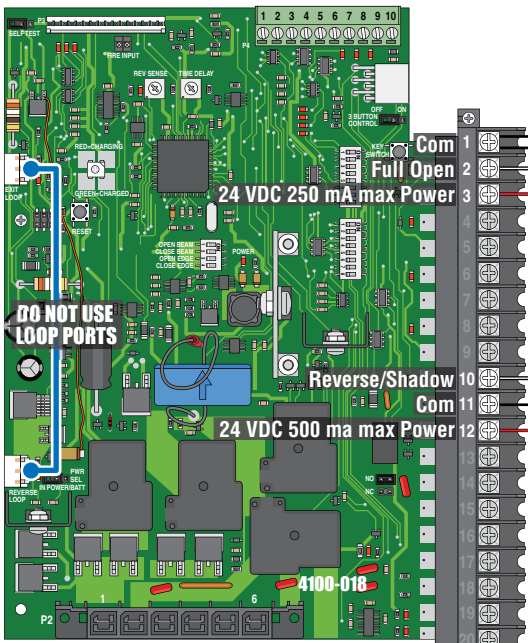
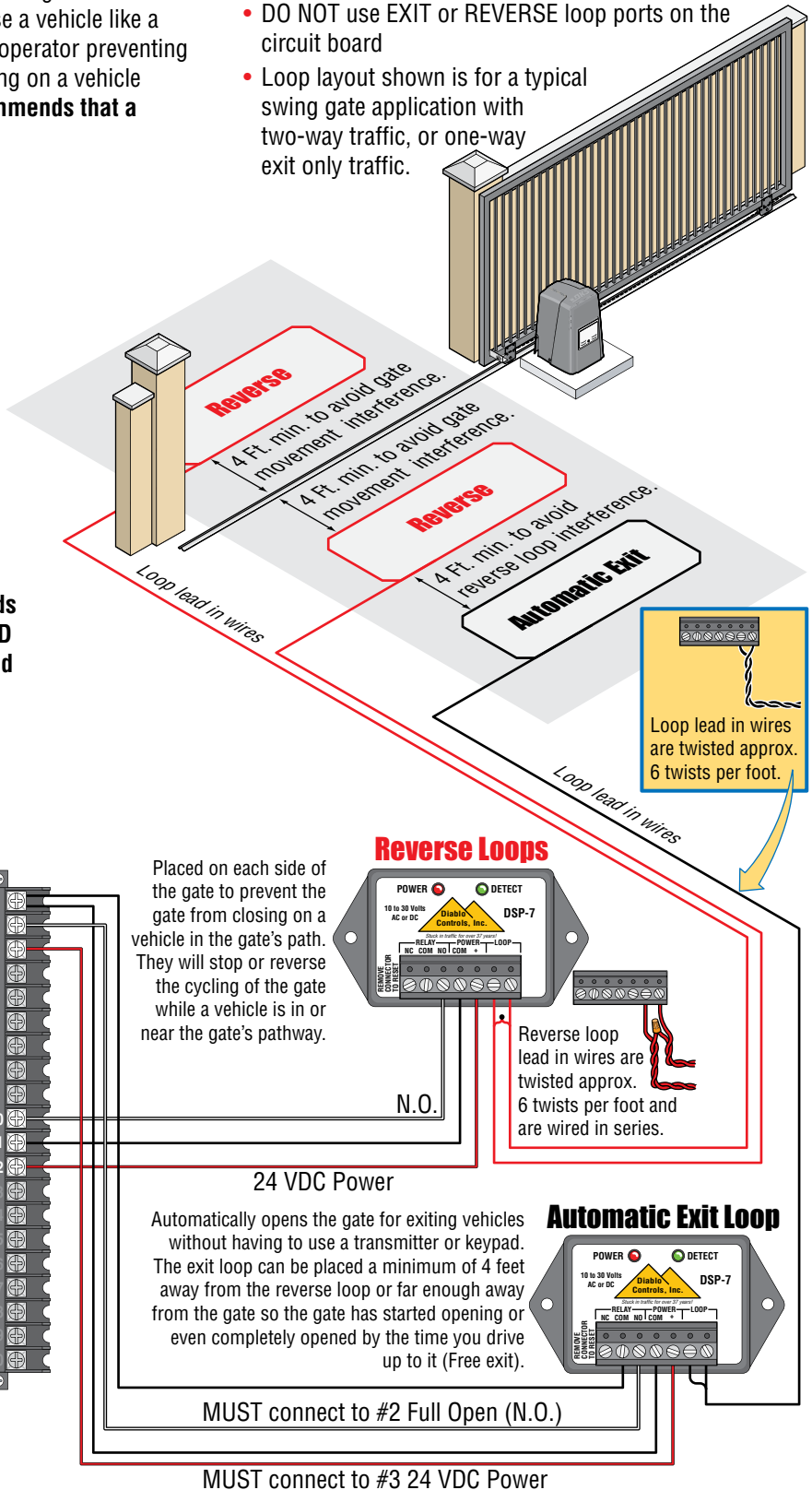

Note: See the specific loop detector instruction sheet for more information.

Single Channel Low Current Draw Loop Detector - P/N 9402-050

MUST connect to #3 24 VDC Power

# SECTION 5 - MAIN TERMINAL WIRING

## 5.1 Terminal Descriptions

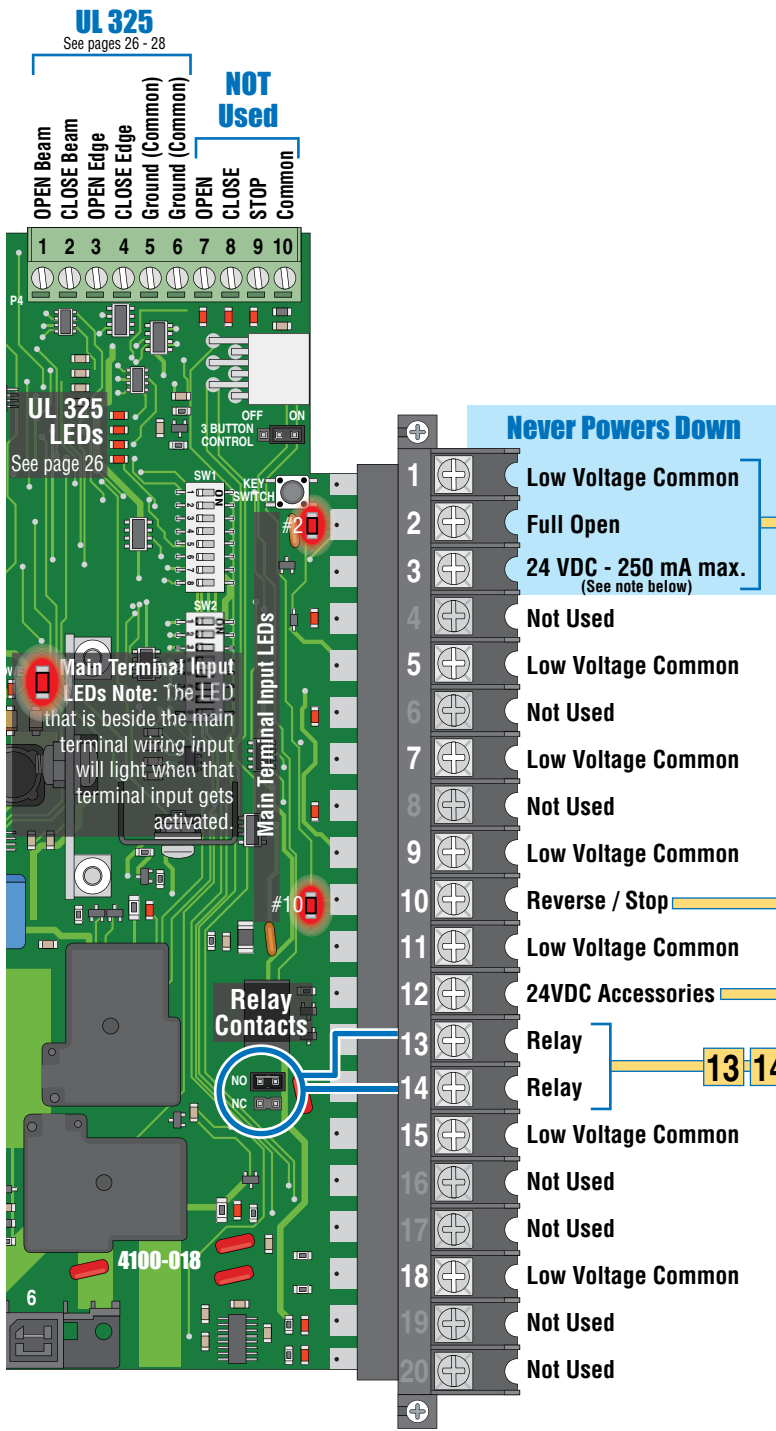

Terminals 1, 2 and 3 are ALWAYS powered up, even after circuit board has powered down to manage the power drain on the batteries.  
**Opening devices MUST connect to terminal 2.**  
**IMPORTANT:** ANY access control device (radio receiver, key switch, exit loop or safety opening device) needs a relay contact time of **AT LEAST 1 SECOND** to bring the circuit board out of "idle time" and operate gate. See page 20.

This input **ONLY** functions when gate is **fully opened** or in the **closing cycle**.

- When gate is closing: SW 1, **switch 4 is OFF**, an input to main terminal 10 (eg: photo beam gets obstructed) will **reverse** and open the gate.  
**Note:** If the auto-close timer is ON, when gate reaches the open position, timer will time out and close the gate.
- When gate is closing: SW 1, **switch 4 is ON**, an input to main terminal 10 (eg: photo beam gets obstructed) will **stop** the gate, then continue to close the gate when input is clear (Used to help prevent tailgating vehicles from unauthorized entry). See page 23 for more information.

SW1, **switch 8 MUST be OFF:** 24-VDC 500 mA accessory power can be provided for desired accessories wired to terminal 12.

**DO NOT** turn ON SW1, switch 8.

**Note:** power to terminal 12 is **ONLY** available when the gate is opening, open, or closing. Power is OFF when the gate is closed.

Operation of relay is dependent on setting of SW 1, **switches 6 and 7.** **Relay contacts** can be set for Normally Open (NO) or Normally Closed (NC) operation.  
 Contact rating is 1 amp maximum at 24-volts DC.

**Terminal #3 Note:**  
 Exceeding 250 mA of power from this terminal may cause the circuit board transformer to overheat, causing intermittent problems.

**20-Pin Main Terminal**

# 5.2 Control Wiring

## UL 325 10-Pin Terminal

**UL 325**  
See pages 26 - 28

- 1 OPEN Beam
- 2 CLOSE Beam
- 3 OPEN Edge
- 4 CLOSE Edge
- 5 Low Voltage Common
- 6 Low Voltage Common
- 7 **Not Used**
- 8 **Not Used**
- 9 **Not Used**
- 10 **Not Used**

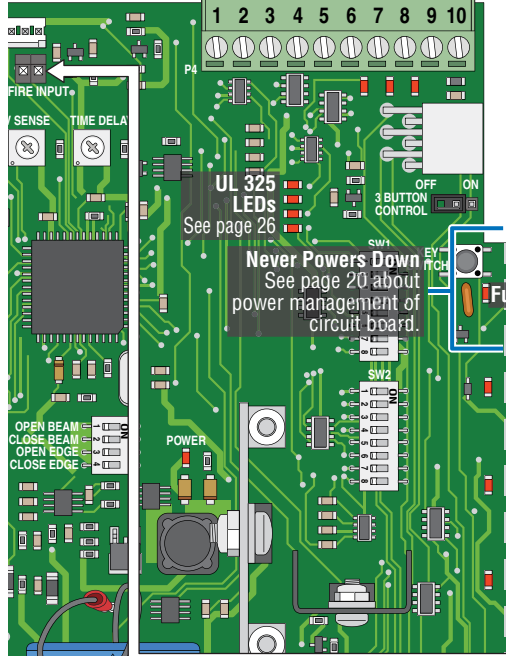

**Important:** Controls intended for user activation must be located at least six (6) feet away from any moving part of the gate and where the user is prevented from reaching over, under, around or through the gate to operate the controls. Emergency access controls only accessible by authorized personnel (e.g., fire, police, EMS) may be placed at any location in the line-of-sight of the gate.

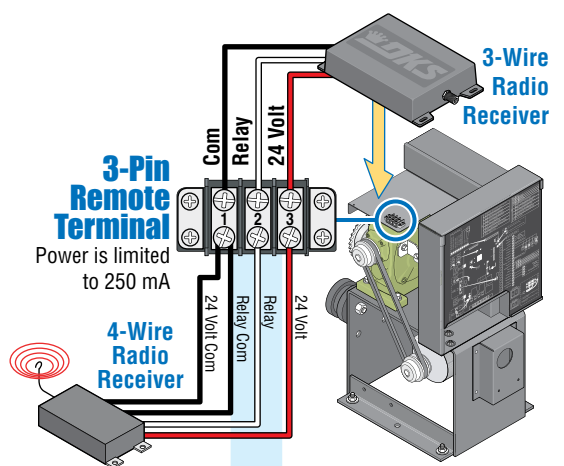

**Main Terminal #3 Note:** Exceeding 250 mA of power from this terminal may cause the circuit board transformer to overheat, causing intermittent problems.

Note: All stand-alone and telephone entry devices must use a separate power source.

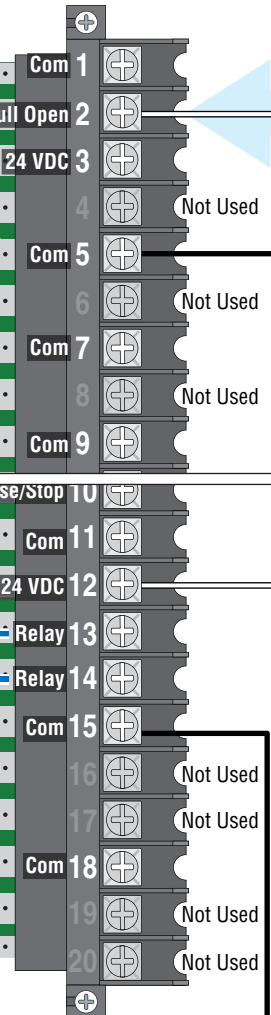

**#2 Terminal Note:** ONLY connect OPENING devices to terminal #2 to open the gate.

**IMPORTANT:** Radio receiver, key switch, exit loop or safety opening device needs a relay contact time of **AT LEAST 1 SECOND** to bring the circuit board out of "idle time" and operate gate. See page 20.

**Fire Dept Open**  
Gate will **ONLY OPEN** when this device is activated by authorized personnel **ONLY** (fire, police, EMS) and operator has power. Alarm will sound during entire open cycle. Operator will then go into a hard shutdown once fully opened. Operator **MUST** be reset to function normally again. This device **MUST** be mounted in the line-of-site of gate so authorized personnel can monitor gate movement.  
**Activation Note:** Activation of this device will **OPEN** gate regardless of the status of the open direction monitored external entrapment protection device(s). If gate is opening, and the operator's **inherent** entrapment protection system detects an obstruction, the operator will reverse approx. 2 inches and go into a hard shutdown. Operator reset button **MUST** be pushed to function again **OR** cycle operator's power.

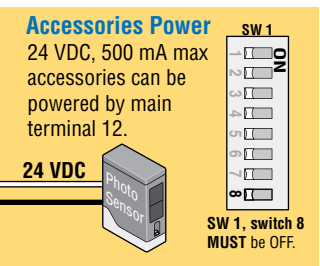
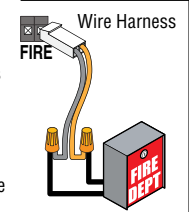
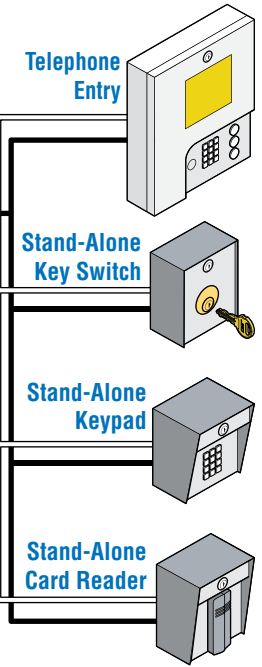

Type of wiring to be used on ALL external devices:  
A) Type CL2, CL2P, CL2R, or CL2X.  
B) Other cable with equivalent or better electrical, mechanical, and flammability ratings.

## 20-Pin Main Terminal

# SECTION 6 - OPERATING INSTRUCTIONS

## IMPORTANT SAFETY INSTRUCTIONS

**WARNING** - To reduce the risk of injury or death:

1. READ AND FOLLOW ALL INSTRUCTIONS.
2. Never let children operate or play with gate controls. Keep the remote control away from children.
3. Always keep people and objects away from gate. **NO ONE SHOULD CROSS THE PATH OF THE MOVING GATE.**
4. Test the operator monthly. The gate **MUST** reverse on contact with a rigid object or stop or reverse when an object activates the non-contact sensors. After adjusting the force or the limit of travel, retest the gate operator. Failure to adjust and retest the gate operator properly can increase the risk of injury or death.
5. Use the emergency release only when the gate is not moving and power has been shut-off.
6. **KEEP GATES PROPERLY MAINTAINED.** Read the owner's manual. Have a qualified service person make repairs to gate hardware.
7. The entrance is for vehicles only. Pedestrians must use separate entrance.
8. **SAVE THESE INSTRUCTIONS.**

## 6.1 Operator Controls

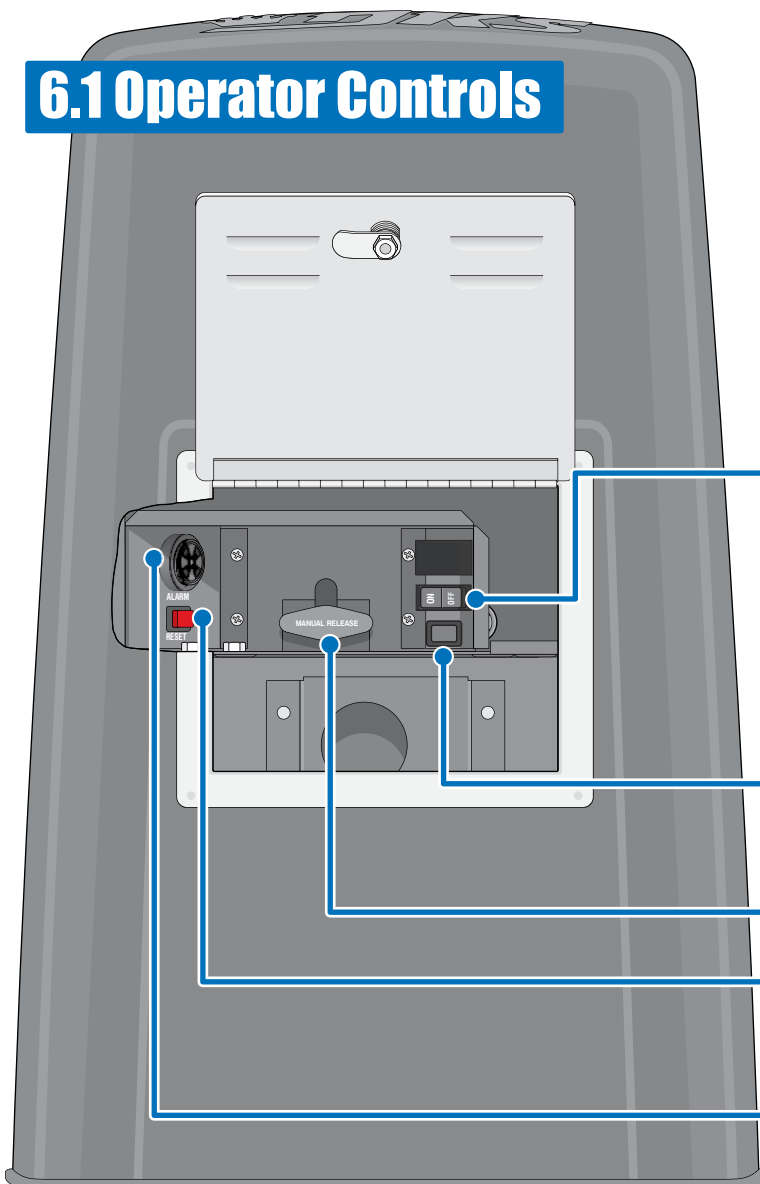
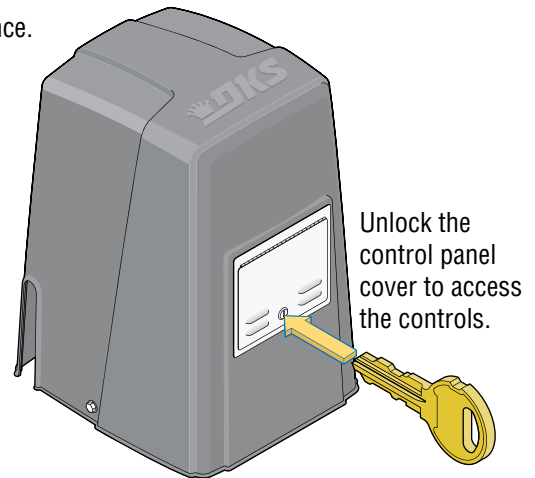

**DC Power Switch** - Powers the DC ON (toggle left) or OFF (toggle right).

**Note:** When powering up operator, the key switch  **MUST** be pressed (located on circuit board) AFTER power switch is turned ON to power up operator.

**PUSH TO OPERATE**  
technician use only

**Push to Operate Button** - Push to cycle the operator. It will use the auto-close timer when turned ON to close the gate. Opens gate fully.

**Manual Release** - See page 35.

**Alarm Reset Button** - Push to turn off the entrapment alarm after a **HARD** shutdown has occurred.

**Alarm Siren**

## 6.2 Shutdown Conditions

Under various entrapment conditions the operator will assume either a **soft** or **hard (alarm)** shutdown. To determine what type of reset action is required, you will need to understand how the different entrapment conditions affect the gate operator.

### Soft Shutdown (NO Alarm will Sound)

This occurs in various situations where the inherent or external entrapment protection devices have been activated. In a soft shutdown condition, the operator **will not** respond to any input that was present when the entrapment protection device sensed an obstruction. If the gate stops at the open position, the operator will not respond to the automatic close timer.

- **Example 1** - A time clock keys the gate open in the morning and an entrapment protection device senses an obstruction prior to the gate reaching the full open position. If the entrapment is sensed by the inherent system, the gate will reverse and run back to the closed position. The time clock input is still present, but the gate will not re-open.

Note: In some systems, the time clock input comes from the telephone entry system relay. This same relay may also provide open commands for a card reader, MicroPLUS transmitters and the visitor telephone entry. If so, these devices will also be disabled in a soft shutdown condition.

- **Example 2** - If the gate is closing and an entrapment protection device is activated, the gate will either stop or reverse and run back to the open position, depending upon if the secondary or inherent device was activated. The automatic close timer will not close the gate.
- **Example 3** - Vehicle arrives at exit loop and gate runs towards the open position. If the inherent entrapment protection gets activated during this opening cycle, the gate reverses and runs back to the closed position. After the inherent entrapment protection is cleared, if the vehicle is still present at the exit loop, a soft shutdown condition does not occur. The exit loop input provides an immediate reset of the operator and the gate will again run to the open position.

### Resetting a Soft Shutdown

In some conditions, a soft shutdown will reset as soon as the entrapment condition clears. For example, if a non-contact sensor (photocell) is sensing an obstruction, the operator will stop the gate and assume a soft shutdown condition. When the photocell clears, the operator will return to normal operation.

When the operator is in a soft shutdown, activation of any “intended input” will reset the operator. An “intended input” includes any command, any standard safety input and any loop input. Activating any of these inputs will reset the gate. At that point the gate will return to normal operation. If the gate is open, the automatic close timer will then time out and close the gate.

### Hard Shutdown (Alarm Activated)

**A hard shutdown condition occurs when: (1.) The inherent entrapment protection system (Type A) gets activated TWO consecutive times before the gate completes the open or close cycle. (2.) The reversing edge (Type B2) gets activated and reverses but before the gate completes the reverse cycle the inherent entrapment protection system (Type A) gets activated.**

- **Example of a Hard Shutdown** - The gate is closing and the inherent entrapment protection system senses an obstruction and causes the gate to reverse direction. As the gate begins to run in the open direction, a second obstruction is sensed prior to the gate reaching the full open position. Once the second obstruction has been sensed, the operator will stop, **the audio alarm will sound and all standard inputs are shut down** (including open commands, safety commands, loop inputs, etc.).
  - **To silence the alarm**, press the alarm reset button or after 5 minutes, the audio alarm will shut off but will “chirp” every 5 seconds. This indicates that the operator is in a hard shutdown condition (The alarm reset button must be pressed to stop the alarm “chirping”).

### Resetting a Hard Shutdown

The operator is in a hard shutdown condition when the audio alarm is sounding OR “chirping” every 5 seconds.

- Before resetting a hard shutdown, determine why the shutdown occurred. Inspect the gate for any obstructions along its path that could have activated the inherent entrapment sensing system. Inspect the gate and gate hardware.

**The audio alarm will sound for five minutes, or until the operator’s alarm reset button is pushed. After (5) five minutes the alarm will “chirp every 5 sec.” and the hard shutdown condition will remain in affect until the alarm reset button is pushed.**

Once the operator has been reset, an open or close command is needed to start the gate operator. Most activating commands will cause the gate operator to cycle to the open position. This includes activation of a key switch or open command and activation of an automatic exit loop. Activation of a close command will run the gate to the closed position.

Note: DoorKing operators have a built-in alarm reset push button mounted on the operator (See previous page for alarm reset button location). Activating this button will return the gate operator to normal operation, but will not cycle the gate operator.

## 6.3 Manual Gate Operation

**Caution:** Never attempt to manually operate any gate until you have verified that **ALL** power to operator has been shut-off.

### 1 Pull Manual Release Handle

Pull straight **OUT** as far as possible and then **UP**.

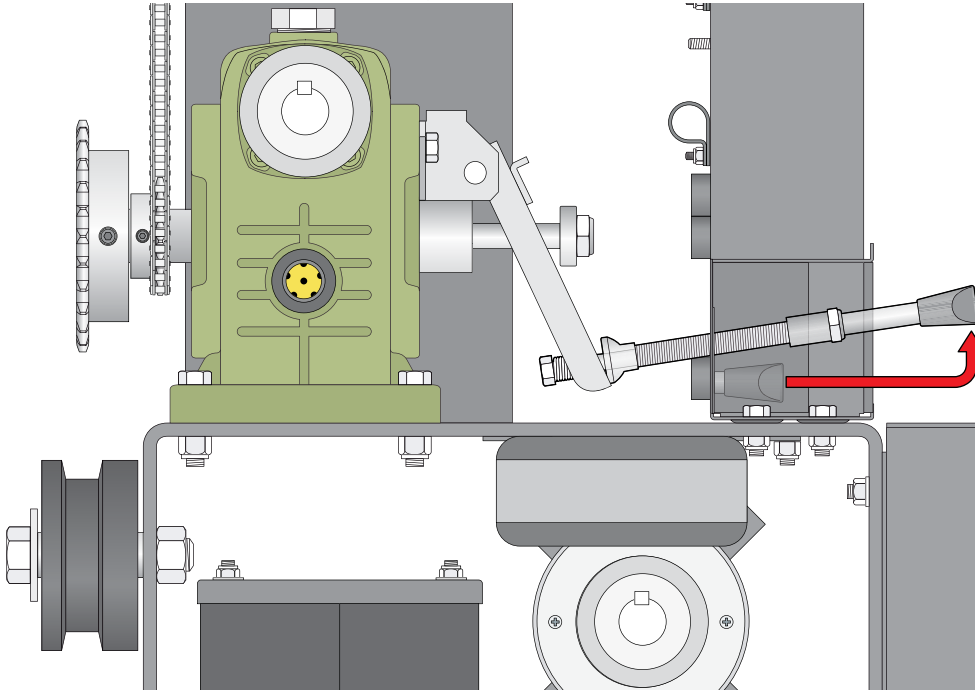

### 2 Release Handle

With handle in UP position, slide back down to lock it in manual release position.

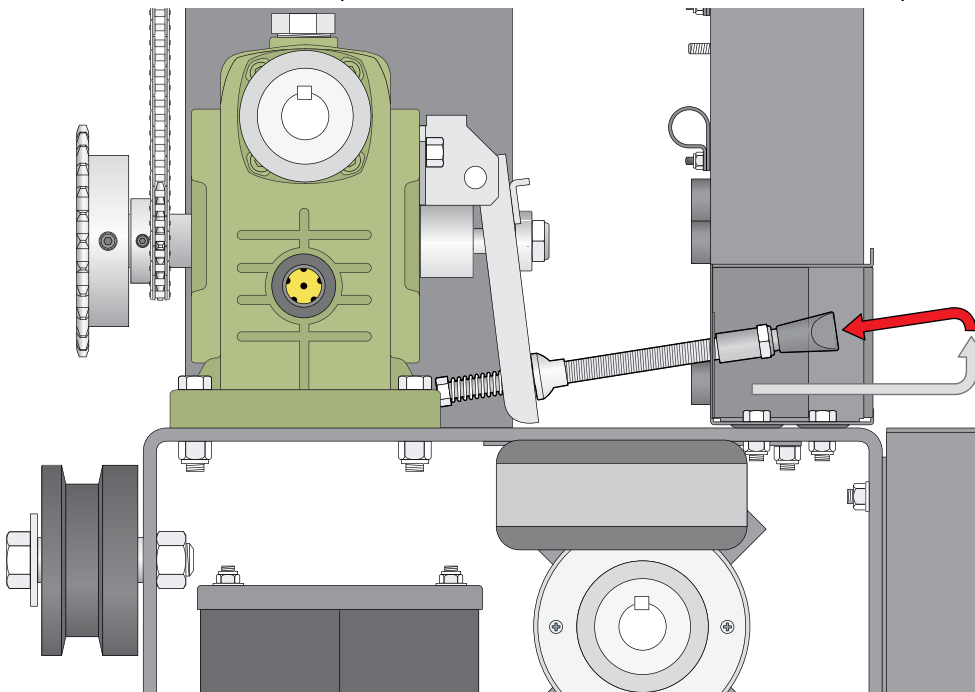

### 3 Manually Push Gate to Desired Position

# SECTION 7 - MAINTENANCE AND TROUBLESHOOTING

Inspection and service of this gate operator by a qualified technician should be performed anytime a malfunction is observed or suspected. High cycle usage may require more frequent service checks.

## 7.1 Maintenance

When servicing the gate operator, always check any external reversing devices (loops, photocells, etc.) for proper operation. If external reversing devices cannot be made operable, do not place this operator in service until the malfunction can be identified and corrected.

**Always check the inherent reversing system when performing any maintenance. If the inherent reversing system cannot be made operable, remove this operator from service until the cause of the malfunction is identified and corrected. Keeping this operator in service when the inherent reversing system is malfunctioning creates a hazard for persons which can result in severe injury or death should they become entrapped in the gate.**

When servicing this gate operator, always turn power **OFF!!** If gearbox requires oil, use only Mobil SHC-629 Synthetic Gear Oil. Do not completely fill gearbox with oil. Gearbox should be half full only. Do not exceed this level.

Operator Component	Maintenance	Monthly Interval		
		1	6	12
<b>Warning Signs</b>	Check that warning signs are on BOTH sides of the gate area.	✓		
<b>Alarm</b>	Activate the primary (inherent) reverse system by blocking the gate with a solid object. When the gate reverses, block the gate in the opposite direction prior to the limit being reached. The entrapment alarm should activate. Press the alarm reset button to silence the alarm.	✓		
<b>Drive Belt</b>	Check for alignment, tightness and wear.		✓	
<b>Chain</b>	Check for sagging. Tighten if necessary.		✓	
<b>Fire Dept.</b>	Check emergency vehicle access device for proper operation.	✓		
<b>Gate</b>	Inspect for damage. Check gate wheels, rollers and guides for wear and grease if necessary.		✓	
<b>Grease</b>	Wheels, guide rollers and limit nuts if necessary.	✓	✓	
<b>Loop(s)</b>	Check vehicular exit and reverse loops for proper operation.	✓		
<b>Inherent Reverse System</b>	Check that the gate reverses on contact with an object in both the opening and closing cycles. See page 43. Adjust the reversing sensor and/or clutch if necessary.	✓		
<b>Pulleys</b>	Check for alignment. Check setscrews.		✓	
<b>Manual Release</b>	Check manual release for proper operation. See page 42.	✓		
<b>External Reverse Devices</b>	Check external reverse devices stop or reverse the gate when activated. See page 43.	✓		
<b>Batteries</b>	Check the batteries for any leakage or loose connections. Batteries should be replaced every two years.	✓		
<b>Complete System</b>	Complete check of gate and gate operating system.			✓

## 7.2 Built-in Diagnostics

This gate operator is designed with built-in diagnostics that will alert you to potential or existing problems that the microprocessor has detected. Specific fault conditions are checked and the operator will signal that a fault exist through the built-in alarm.

**Constant alarm is heard when power is applied:** This indicates that the limit switch wire harness is not connected to the circuit board. In this condition, the operator will not run and the tone will continue until the fault is corrected. Check to be sure that the limit switch plugs are properly inserted into P2 and P8.

**Constant alarm is heard:** This indicates that the operator is in a hard shutdown condition. The alarm will continue to sound for five minutes, and then will “chirp” once every five seconds. The alarm reset button must be pressed or power must be removed and then reapplied to return the operator to normal operation.

**Short “alarm chirp” is heard every five seconds:** This indicates that the operator has been in a hard shutdown condition in excess of five minutes. This will continue until the alarm reset button is pressed or until power is removed from the operator.

**Operator runs for 1 second and stops, two short “alarm chirps” are heard:** This indicates that there may be a fault with the primary current sensor circuit. Check that the black current sensor wire has been passed through the hole in the primary current sensor donut on the circuit board with the correct number of loops (1/2 HP motor - 2 loops, 1 HP motor - 1 loop).



## 7.3 Troubleshooting

Have a good VOM meter with Min/ Max test button to check voltages and continuity. A Meg-Ohm meter capable of checking up to 500 meg-ohms of resistance is necessary to properly check the integrity of the ground loops. When a malfunction occurs, isolate the problem to one of three areas: 1) the operator, 2) the loop system, 3) the keying devices. **Use caution when checking high voltage areas.**

1. Check the input indicator LEDs. They should only come ON when a keying device (card reader, push button, etc.) is activated. If any of the input LEDs are ON continuously, this will cause the gate operator to hold open. Disconnect the keying devices one at a time until the LED goes OFF.
2. Check any external entrapment protection devices. Any short or malfunction in these devices can cause the gate operator to stop or to hold open.
3. A malfunction in a loop or loop detector can cause the gate operator to hold open, or to not detect a vehicle when it is present over the loop. The LEDs next to the loop detector ports on the operator circuit board will light only when the loop has detected an object above it. If the LEDs stays on after the object has gone, then the loop detector has malfunctioned. Pull the loop detector circuit boards from the loop ports on the operator circuit board. If the malfunction persists, the problem is not with the loop system. For more information on trouble shooting loops and loop detectors, refer to your loop detector instruction sheet and to the DoorKing Loop and Loop Detector Information Manual.
4. Check to be sure that there are no shorted or open control wires from the keying devices to the gate operator. If a keying device fails to open the gate, momentarily jumper across terminals 1 and 2 (or 1 and 6) on the gate operator circuit board. If the gate operator starts, this indicates that a problem exist with the keying device and is not with the gate operator.
5. Check the supply voltage line. A voltage drop on the supply line (usually caused by using too small supply voltage wires) will cause the operator to malfunction.

Symptom	Possible Solution(s)
Operator will not run. Power LED is OFF.	<ul style="list-style-type: none"> <li>• Check that power to the operator is turned ON.</li> <li>• Check that <b>ANY</b> access control device wired to terminals 1, 2 &amp; 3 (radio receiver, key switch, exit loop or safety opening device) has a relay contact time of <b>AT LEAST 1 SECOND</b> to bring the circuit board out of "idle time" and operate gate.</li> <li>• Check for DC power at the power input terminals. If power is absent, check incoming power to operator.</li> <li>• Be sure DC power switch is ON. Check for 24 VDC at P2, terminals 1 (+) and 2 (-). If no power, faulty bridge rectifier or toroidal transformer. If power is present, possible faulty board.</li> </ul>
Operator will not run. Power LED is ON.	<ul style="list-style-type: none"> <li>• Insure that a minimum of one (1) external entrapment protection device is connected in <b>EACH</b> direction of gate travel (minimum of 2 external devices required) and the inputs are connected and enabled (UL 325 DIP-switches are turned ON).</li> </ul>
Operator will not run, entrapment protection input(s) LED is ON.	<ul style="list-style-type: none"> <li>• The entrapment protection device has a fault or the wiring to it is shorted.</li> </ul>
Operator will not run, entrapment protection input(s) LED is Blinking.	<ul style="list-style-type: none"> <li>• The entrapment protection device is not connected or the wiring to it is open.</li> </ul>
Gate will not reverse when an obstruction is encountered.	<ul style="list-style-type: none"> <li>• Check ERD (Reverse Sensor) setting.</li> </ul>
Gate opens a short distance, then stops and reverses.	<ul style="list-style-type: none"> <li>• Check the reversing sensitivity.</li> <li>• Disconnect the gate from the gate operator and check that the gate slides freely without binding.</li> <li>• Gate might be too heavy.</li> <li>• Continue troubleshooting.</li> </ul>

## 7.3 Troubleshooting Continued

Symptom	Possible Solution(s)
Gate opens but will not close.	<ul style="list-style-type: none"> <li>• Check the input LEDs. Any ON will hold the gate open and indicates a problem with a keying device.</li> <li>• Check the secondary safety devices. Any activated will hold the gate open and indicates a problem with the safety device.</li> <li>• Check the loop detectors. Any activated can hold the gate open and indicates a problem with the loop detector or ground loop.</li> <li>• Operator may be in a “soft shutdown.” Activate any keying device to determine if operator returns to normal operation.</li> <li>• If automatic close is desired, be sure SW-1, switch 2 is ON.</li> </ul>
Gate closes but will not open.	<ul style="list-style-type: none"> <li>• Operator may be in a “soft shutdown.” Check input LEDs. If any are ON, momentarily disconnect, then re-connect the wire going to the respective terminal. Operator should open.</li> <li>• Check to be sure that the operator is running in the proper direction. Turn power OFF, and then back ON. Activate a keying device. Operator should run in the open direction. If operator runs in the close direction, turn power OFF and change direction switch SW-1, switch 1. Go to above section if operator now opens but will not close.</li> <li>• Be sure that the respective LED on the control board lights when the keying device connected to the respective terminal is activated. If LED does not light, momentarily place a jumper wire from terminal 1 to the input terminal being checked. If LED lights and gate opens, problem is with the keying device. If LED does not light, replace control board.</li> </ul>
Gate starts to close, then reverses to open.	<ul style="list-style-type: none"> <li>• Check that the reverse sensitivity is properly adjusted.</li> <li>• Disconnect the gate from the operator and check that the gate operates freely without any binding.</li> <li>• Check the loop detector LEDs and input LEDs. Any that flash ON will cause the gate to reverse.</li> <li>• Check for proper loop wiring. A mis-wired loop detector will cause the gate to reverse.</li> <li>• Continue troubleshooting.</li> </ul>
Gate closes and then re-opens.	<ul style="list-style-type: none"> <li>• Check for any input or loop detector LEDs that are ON.</li> <li>• Check that the operator is running in the proper direction (see “gate closes but will not open” above).</li> </ul>
Alarm sounds for 5 minutes and then chirps once every 5 seconds. Operator will not run.	<ul style="list-style-type: none"> <li>• Operator is in a “hard shutdown” condition. Alarm reset button must be pressed to return operator to normal operation.</li> </ul>
Operator has intermittent functionality problems that vary.	<ul style="list-style-type: none"> <li>• The main terminal #3 250 mA power has been exceeded. Check total amp draw of connected device(s).</li> </ul>

## 7.4 Accessory Items

### UL 325 Monitored Entrapment Protection Devices available for the 9024 slide gate operator.

#### Type B2 Contact Sensors (Reversing Edge)

DoorKing 8080 Series Sensing Edges  
Miller Edge Sensing Edges - all models with a T2 (resistive) termination.  
Miller Edge wireless monitored transmitter/receiver kit model RB-G-K10  
ASO GMBH Sentir GF Series sensing edges

#### Type B1 Non-contact Sensors (Photo Cell)

DoorKing Model 8080-057 Retro-Reflective Photocell  
Miller Edge Reflective-Guard Model RG  
Miller Edge Prime-Guard Model PG  
EMX Industries Model IRB-MON  
EMX Industries Model IRB-RET  
Omron Model E3K-R10K4  
Seco-Larm Model E-936-S45RRGQ  
Seco-Larm Model E-960-D90GQ

#### Monitored Expansion Kit

Miller Edge Multi-Input Module Model MIM-62

### Accessory items available for the model 9024 slide gate operator.

**Loop Wire** - 18 AWG loop wire with XLPE insulation is ideal for ground loops. Available in 500 and 1000 foot rolls. Red, blue or black insulation.

**Pre-Fab Loops** - Prefabricated ground loops. 24-foot circumference with 50-foot lead-in. Available in yellow, red or blue jackets. Not for use in asphalt roadways.

**Loop Test Meter** - Meg-ohm meter checks the integrity of ground loops. P/N 9401-045

**Time Clock** - 7 day time clock can be used to automatically open gate at pre-set time and days. Compact clock fits inside the operator. 7 day clock - P/N 2600-791

**V-Wheels** - 4 inch and 6 inch. UHMW or Steel. Roller bearings or sleeve bearings. Single or tandem wheel configurations.

**Endless Idler Assembly with Protective Cover** - Use when gate operator chain needs 180° return. P/N 2600-818

**Guide Rollers with Protective Covers** - A variety of sizes to support slide gates.

**Gate End Retainer** - Fits on top of end post and helps stabilize the end of the gate in the open or closed position (End post NOT provided). P/N 1204-004

**Post Mount Kit** - Required for post mount installation. P/N 9000-015.

**Chain Tray Kit** - 10 Ft. section. Sections connect together to fit any length gate. P/N 2601-270

**Additional #40 Chain** - 20 ft. per box. P/N 2600-442

**Surge Devices** - High and low voltage surge suppressors help prevent circuit board failure caused by lightning strikes and power surges. High Voltage - P/N 1879-010 Low Voltage - P/N 1878-010

**Speed Bumps** - Prefabricated six-foot speed bump reduces traffic speed through gate system. P/N 1610-150

**12 Volt 18 Amp/Hr Extended Battery** - P/N 1801-004. Two (2) required.

**24 VDC Solar Power Kit** - P/N 2000-070.

**Low Current Draw External Loop Detector** - Detectors are solar friendly and mount into solar control box.

Single channel detector - P/N 9402-050

**Plug-In Low Current Draw Loop Detector** - Detectors plug directly into ports on circuit board simplifying wiring. Can be used with solar powered operators.

Single channel detector - P/N 9416-010 Dual channel detector - P/N 9415-010

# Model 9024-381 Solar Input Power ONLY

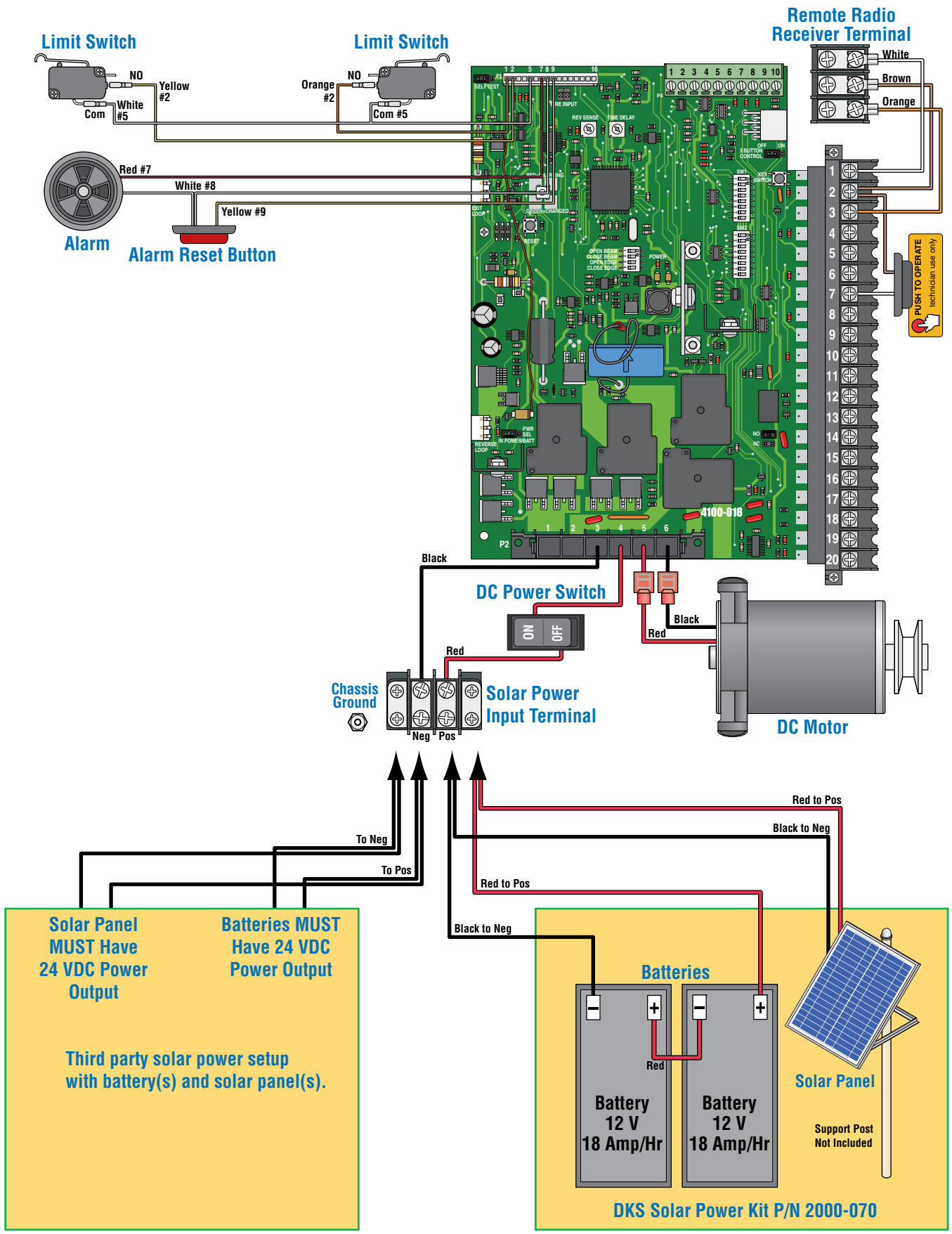

# SECTION 8 - OWNER OF THE GATE OPERATOR

## 8.1 Alarm Sounding OR “Chirping” and Gate WILL NOT Operate

Operator is in a HARD Shutdown Condition: The alarm will sound for (5) five minutes. After five minutes the alarm will start “Chirping” every 5 seconds and continue “Chirping” until operator gets reset.

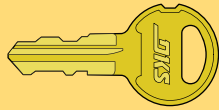

A KEY has been supplied that will unlock the power switch cover on this gate operator.

Note: The owner of the gate operator is responsible for the KEY availability.

### When Alarm is Sounding OR “Chirping” .....

**ALWAYS CHECK THE ENTIRE GATE AREA FOR ANY OBSTRUCTIONS OR DAMAGE FIRST.**



- If a Fire Dept Access Device has been activated by **emergency personnel**, then operator can be **reset** and put back into normal operation again. Alarm will **always** sound when this access device gets activated.
- If the cause of the alarm **CAN** be identified and **CORRECTED**, then operator can be **reset** and put back into normal operation again.
- If the cause of the alarm **cannot be corrected**, shut-off power and **DO NOT** place this operator back into service until the malfunction can be identified and **CORRECTED**.

**IMPORTANT:** Putting this gate operator back into service **WITHOUT CORRECTING** the cause of the alarm could result in severe injury or DEATH!

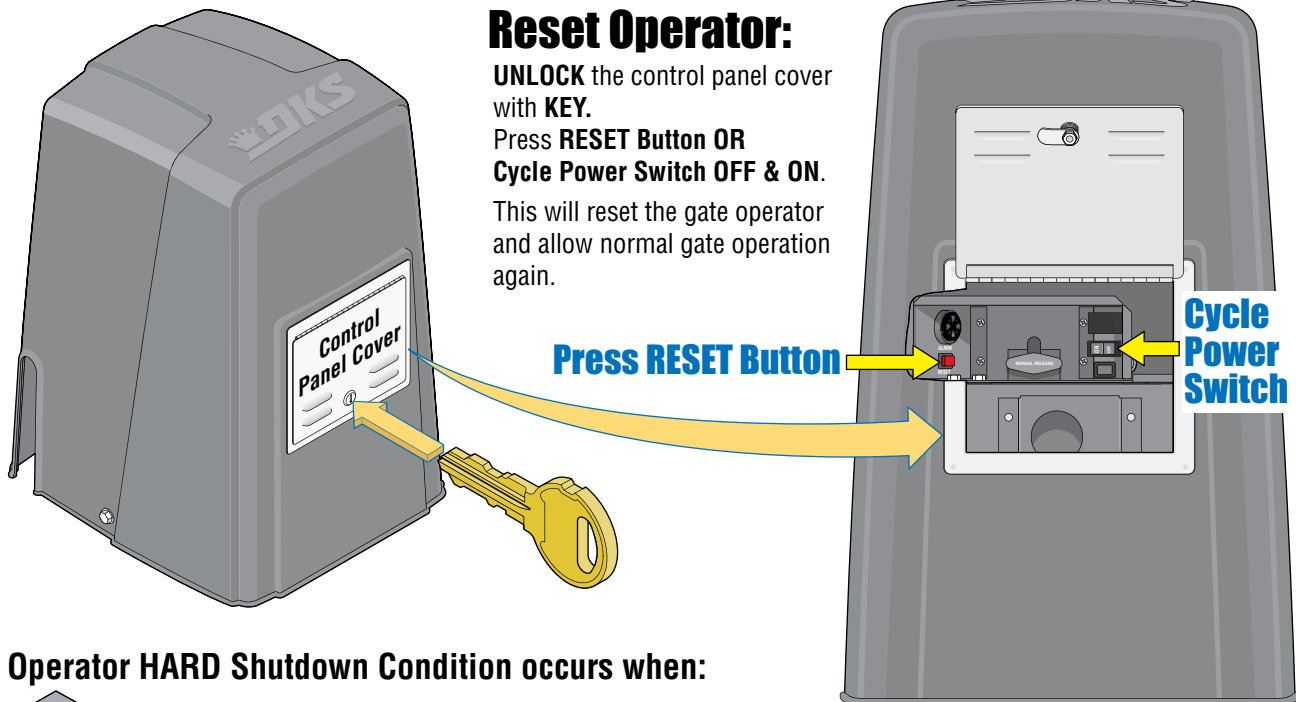

### Operator HARD Shutdown Condition occurs when:



1. Fire Department (Emergency Access) input has been activated by Police, Fire Department, EMT, Ambulance etc.
2. The inherent entrapment protection system (Type A) gets activated TWO consecutive times before the gate completes the open cycle OR the close cycle.
3. The reversing edge contact sensor (Type B2) gets activated and reverses, but before the gate completes the reverse cycle the inherent entrapment protection system (Type A) gets activated.

Please read **SECTION 6 - OPERATING INSTRUCTIONS** for more information about operating this gate operator.

## 8.2 Manual Gate Operation

**Caution:** NEVER attempt to manually operate the gate until you have VERIFIED that power to the gate operator has been SHUT-OFF!

Please read **SECTION 6 - OPERATING INSTRUCTIONS** for more information about operating this gate operator.

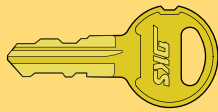

A KEY has been supplied that will unlock the control panel cover on this gate operator.

**Note:** The owner of the gate operator is responsible for the KEY availability.

Gate **CANNOT** be manually PUSHED open until **MANUAL RELEASE HANDLE** has been **RELEASED**.

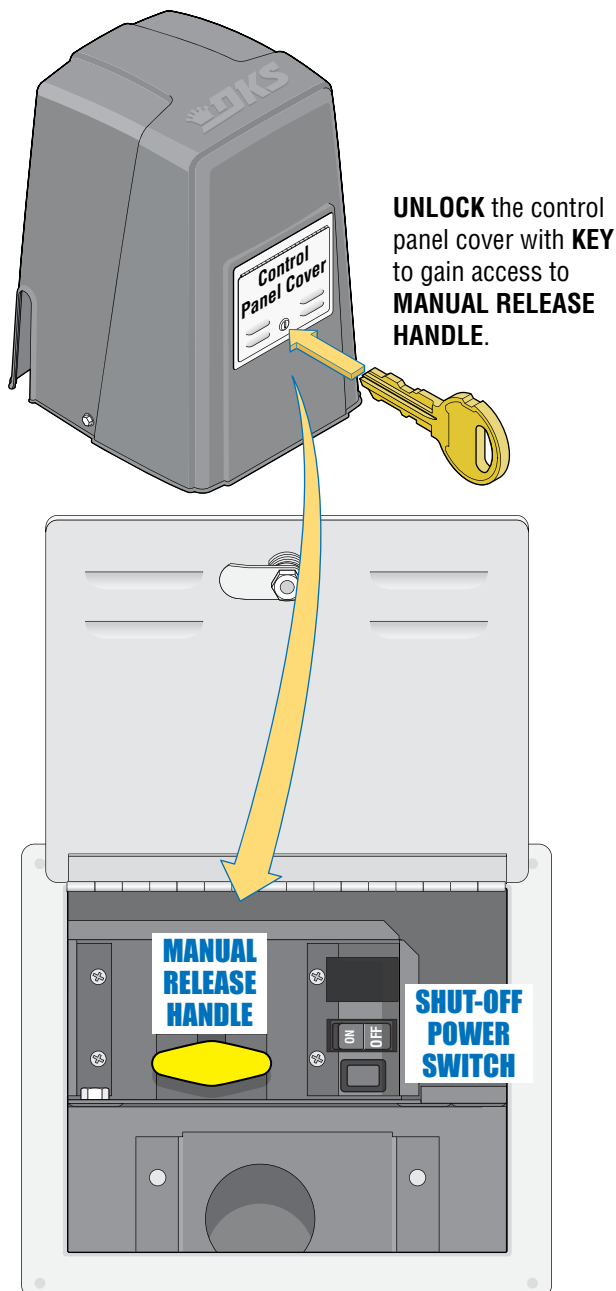

### 1 Pull Manual Release Handle

Pull straight **OUT** as far as possible and then lift handle **UP**.

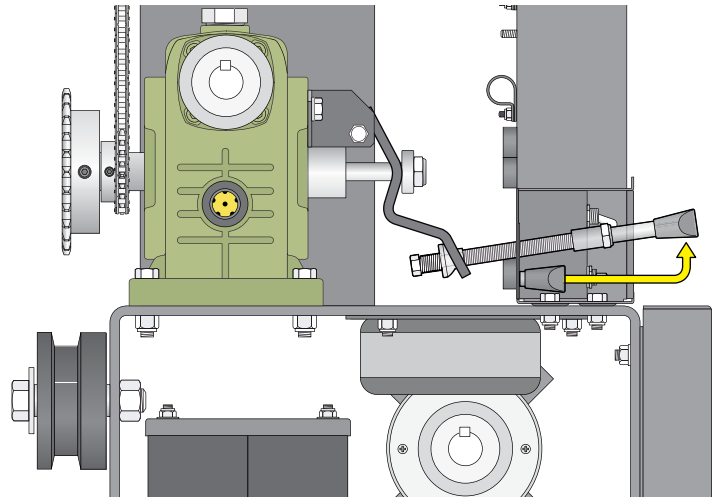

### 2 Release Handle

With handle in **UP** position, slide back down to lock it in manual release position.

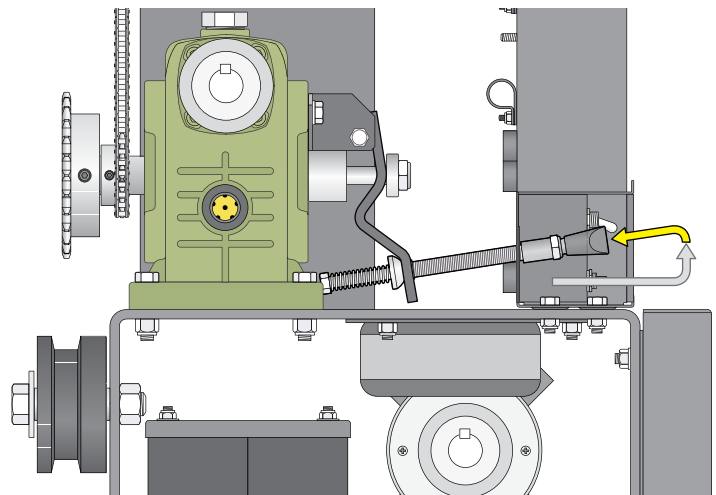

### 3 Manually Push Gate Open

## 8.3 Gate Operator's Monthly Checkup

**Caution:** Make SURE gate area is clear BEFORE testing the gate operator!

**DO NOT** repair or adjust gate systems yourself. Contact a trained gate systems technician with any questions or to make any repairs or adjustments. If you feel uncomfortable performing any of these inspections or testing, a qualified service technician will perform the visual inspections and testing for you. You can find a trained service technician at DoorKing's "Dealer Locator" at [www.doorking.com](http://www.doorking.com)

### Visual Inspection

Visually inspect the rollers, fasteners, brackets and other gate hardware for proper alignment, proper tightness, and signs of damage, breakage, looseness, rust or wear. Moving parts should be lubricated and should not be squeaking. Visually inspect wiring for fraying or exposure. If a malfunction is found, contact a trained service technician to make adjustments or repairs.

### Test Built-In Reversing Sensor

Begin with the gate in the fully **OPEN** position. Stand just outside the path of the gate and close the gate (typically auto-timer will time-out and close gate automatically). As the gate is **closing**, firmly press a solid object against the end of the gate frame in the direction opposing the travel of the gate. The gate should **stop** within 2 sec. and **reverse** to the **OPEN** position. Another input command is needed before the gate will reset and close again. Repeat this test while **opening** the gate. Start from the fully **CLOSED** position. While **opening**, gate should **stop** and **reverse** to the **CLOSE** position. If gate does **NOT** respond like it should in **either** direction of gate travel, contact a trained service technician to make adjustments or repairs.

### Test Photo Sensors

If the gate has a photo sensing device protecting the path of a **closing gate**, perform the following test. Begin with the gate in the fully **OPEN** position. Stand just outside the path of the gate and close the gate (typically auto-timer will time-out and close gate automatically). Pass an object across the path of the closing photo sensing beam. The gate should **stop** within 2 sec. and **reverse** to the **OPEN** position. Typically the auto-timer times out and gate closes again.

If the gate has a photo sensing device protecting the path of a **opening gate**, start from the fully **CLOSED** position. **OPEN** gate. Pass an object across the path of the opening photo sensing beam. The gate should **stop**, the gate will resume opening when the beam is clear. If gate does **NOT** respond like it should in **either** direction of gate travel, contact a trained service technician to make adjustments or repairs.

### Test Reversing Edges

If the gate has a reversing edge(s) protecting the path of a **closing gate**, perform the following test. Begin with the gate in the fully **OPEN** position. Stand just outside the path of the gate and close the gate. As the gate is closing, firmly press a solid object against the reversing edge in the direction opposing the travel of the gate. The gate should **stop** within 2 sec. and **reverse** to the **OPEN** position (typically auto-timer will time-out and close gate automatically). If the gate encounters **another** obstruction before it is closed, the gate will **stop** and reverse to the **OPEN** position **again**. A input command is needed before the gate will reset and close again, auto-timer will **NOT** close gate (Typically, press your remote button for input command). If the gate has a reversing edge(s) protecting the path of a **opening gate**, starting from the fully **CLOSED** position. Stand just outside the path of the gate and open the gate. **OPEN** gate. As the gate is opening, firmly press a solid object against the reversing edge in the direction opposing the travel of the gate. gate should **stop** and **reverse** to the **CLOSE** position. If gate does **NOT** respond like it should in **either** direction of gate travel, contact a trained service technician to make adjustments or repairs.

**Note:** This gate operator uses high levels of force to move the gate and most people underestimate the power of these systems and do not realize the potential hazards associated with this system if **NOT** maintained properly.

**Scheduled maintenance visits are offered by most qualified service technicians to MAINTAIN your gate operator system.**

## 8.4 New Installation Checklist for Installer and Property Owner

**Instructions:** Check the space next to each item (“✓”) to indicate that it has been addressed by installer **AND** property owner. If it is not applicable, enter N/A. Please note that the checklist is intended to be a summary of many **important** automated vehicular gate aspects, **But may not inclusively identify all potential hazards of every specific gate system installation.**

**Each item listed and checked has been examined by the Installer and is CLEARLY understood by the Property Owner.**

Installer	Property Owner	Description
		<b>The operator is installed on a gate used for vehicles only.</b> Verify that separate pedestrian access is provided or available, and the access is such that pedestrians cannot come in contact with the moving vehicular access gate during its entire length of travel.
		<b>Gate/Hardware:</b> Insure that there is a means to prevent the gate from falling over in the event of a roller or hinge failure. Insure the gate has physical limit stops and that gravity will not initiate motion of the gate. Insure that all rollers are guarded or covered to eliminate the possibility of a finger being inserted between the roller and gate.
		<b>Slide Gate:</b> Insure that the maximum opening in the gate and in that portion of the adjacent fence that the gate covers when the gate is in the open position is such that a 2 ¼" sphere cannot pass through the openings up to 72 inches above the ground or to the top of the gate, whichever is less. If the gate and adjacent fence do not meet this requirement, wire mesh (or other means) must be added to meet this requirement before placing the gate system in operation.  Insure that any gaps between the slide gate and stationary posts/pilasters is less than 2 1/4" and that these areas are protected with an entrapment protection device.
		The gate operator system is in compliance with the <b>entrapment protection requirements of UL 325.</b> Identify all potential entrapment zones and ensure they are protected. Potential pinch areas have been guarded so as to be inaccessible OR have a contact (reverse edge) and/or non-contact (photocell) obstruction sensing devices installed. Verify that the system has in place external entrapment protection, independent from the inherent entrapment protection. Edge sensors or photocells are typical, other means are possible. For more information see your <b>specific</b> installation/owners manual for entrapment protection installation and locations.
		The installer has properly adjusted the <b>inherent entrapment protection feature</b> on the gate operator, and has tested the gate to make sure that the gate stops and reverses a short distance upon striking an immovable object.
		Check that placement of <b>user operational controls</b> are six (6) or more feet away from the gate. If any operational control is closer than six (6) feet to the gate, <b>DO NOT</b> place the automated vehicular gate into service.
		<b>Warning signs</b> are to be permanently installed in the area of the gate in such a manner that at least one warning sign is visible by persons located on each side of the gate, for both the secure and unsecure sides of the gate.
		The installer has instructed the property owner in the <b>proper use of the gate operator</b> and has reviewed the operational functions, obstruction-sensing devices, alarm, and reset as outlined in <b>your specific</b> installation/owners manual.
		The installer has instructed the property owner in the proper use of the operator's <b>manual release feature</b> as outlined in <b>your specific</b> installation/owners manual.
		The installer has <b>reviewed all safety instructions with the property owner</b> , including the need to never let children operate or play with gate controls, to keep the remote control away from children, and to always keep people and objects away from the gate.
		The installer has explained to the property owner that a <b>regular maintenance schedule</b> for both the gate and the gate operator is recommended, including regular testing of entrapment protection as outlined in the manufacturer's instructions.
		<b>The installer has left the installation/owners manual with the property owner for future reference.</b>



# Alarm Sounding OR "Chirping" and Gate Will NOT Operate

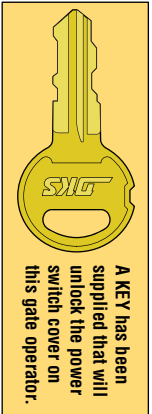

A KEY has been supplied that will unlock the power switch cover on this gate operator.

To obtain key to unlock gate operator contact:

Name \_\_\_\_\_

Phone # \_\_\_\_\_

Operator is in a HARD Shutdown Condition: The alarm will sound for (5) five minutes. After five minutes the alarm will start "Chirping" every 5 seconds and continue "Chirping" until operator gets reset.

## When Alarm is Sounding OR "Chirping" .....

### ALWAYS CHECK THE ENTIRE GATE AREA FOR ANY OBSTRUCTIONS OR DAMAGE FIRST.

- If a Fire Dept. Access Device has been activated by emergency personnel, then operator can be reset and put back into normal operation again. Alarm will always sound when this access device gets activated.
- If the cause of the alarm CAN be identified and CORRECTED, then operator can be reset and put back into normal operation again.
- If the cause of the alarm cannot be corrected, shut-off power and DO NOT place this operator back into service until the malfunction can be identified and CORRECTED.

**IMPORTANT!** Putting this gate operator back into service WITHOUT CORRECTING the cause of the alarm could result in severe injury or DEATH!

### Reset Operator:

UNLOCK the control panel cover with KEY.  
Press **RESET Button OR Cycle Power Switch OFF & ON.**  
This will reset the gate operator and allow normal gate operation again.

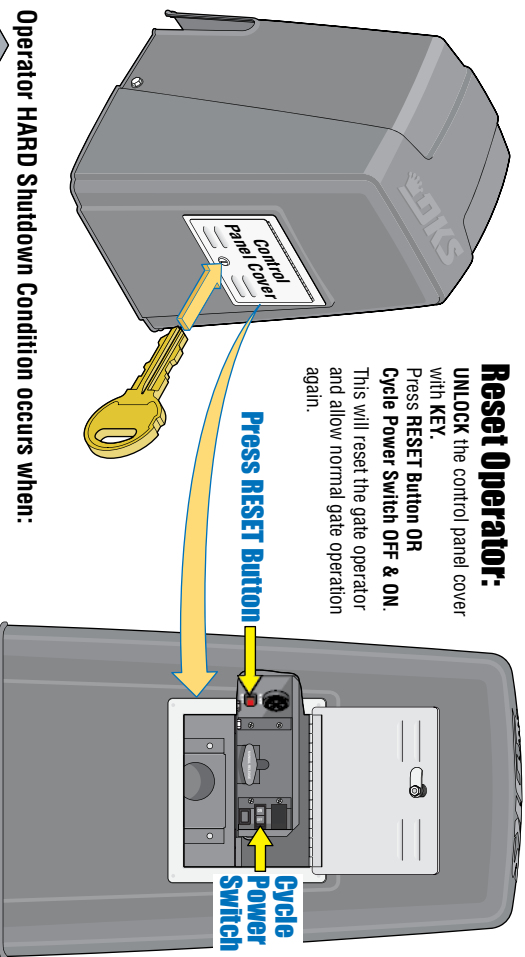

Operator HARD Shutdown Condition occurs when:

1. Fire Department (Emergency Access) input has been activated by Police, Fire Department, EMT, Ambulance etc.
2. The inherent entrapment protection system (Type A) gets activated TWO consecutive times before the gate completes the open cycle OR the close cycle.
3. The reversing edge contact sensor (Type B2) gets activated and reverses, but before the gate completes the reverse cycle the inherent entrapment protection system (Type A) gets activated.

Please read **SECTION 6 - OPERATING INSTRUCTIONS** for more information about operating this gate operator.

# Manual Gate Operation



A KEY has been supplied that will unlock the control panel cover on this gate operator.

To obtain key to unlock gate operator contact:

Name \_\_\_\_\_

Phone # \_\_\_\_\_

**Caution:** NEVER attempt to manually operate the gate until you have VERIFIED that power to the gate operator has been SHUT-OFF!

Gate CANNOT be manually PUSHED open until MANUAL RELEASE HANDLE has been RELEASED.

### 1 Pull Manual Release Handle

Pull straight "OUT" as far as possible and then lift handle UP.

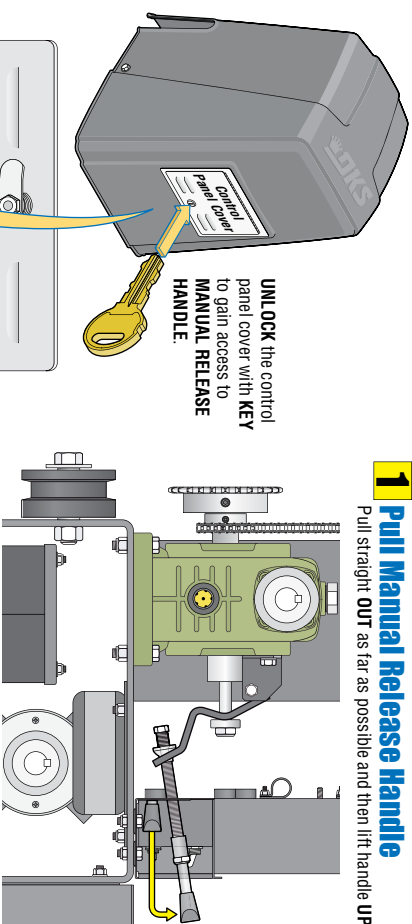

### 2 Release Handle

With handle in UP position, slide back down to lock it in manual release position.

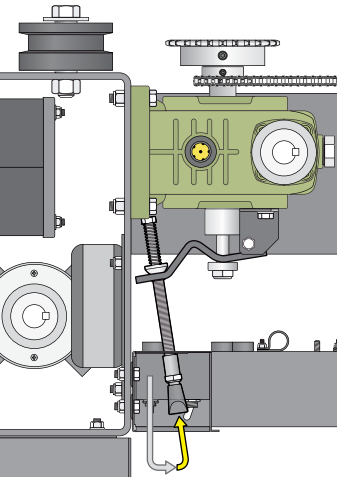

### 3 Manually Push Gate Open

Please read **SECTION 6 - OPERATING INSTRUCTIONS** for more information about operating this gate operator.

# Installation/Owner's Manual

# Model 9024-381

Solar Powered Vehicular Slide Gate Operator

Use this manual for circuit board 4100-018 Revision A or higher.

9024-066-G-9-24

**Bi-Parting Gate Operators CANNOT  
be used with Solar Applications.**

Entrapment Protection must be provided for the gate system where the risk of entrapment or obstruction exists. The operator will NOT run without one or more monitored type B1 or B2 entrapment protection devices in EACH direction of gate travel.

**UL 325 August 2018 Standard**



**THIS PRODUCT IS TO BE INSTALLED AND SERVICED BY A TRAINED GATE/DOOR SYSTEMS TECHNICIAN ONLY.**  
Visit [www.doorking.com/dealer-locator](http://www.doorking.com/dealer-locator) to find a professional installing and servicing dealer in your area.

[www.doorking.com](http://www.doorking.com)

DoorKing, Inc.  
120 S. Glasgow Avenue  
Inglewood, California 90301  
U.S.A.  
Phone: 310-645-0023  
Fax: 310-641-1586