

Installation/Owner's Manual

1838 PC Programmable

Multi-Door Access Controller

Use this manual for circuit board 1838-010 Revision Z or higher.

1838-065 Issued 3-19

26, 30 and 31-Bit Wiegand Compatible



Date Installed: _____

Installer/Company Name: _____

Phone Number: _____

Circuit Board
Serial Number
and Revision Letter: _____

Leave Manual with Owner

Download **REMOTE ACCOUNT MANAGER** Software **FREE** at:
<http://www.doorking.com/telephone/software>

Copyright 2019 DoorKing®, Inc. All rights reserved.

Version G



Conforms To UL STD 294
Certified To CAN/ULC-S319-05



QUICK GUIDE: Terminal Descriptions

See section 2.3 for terminal wiring.

800 ft. max. with 24 AWG wire.
1600 ft. max. with 22 AWG wire.
(Wiring **MUST** be twisted and completely isolated from the ground)

Phone Line Connection (Ring)

Phone Line Connection (Tip)

Earth Ground Only (See Section 2.1.3).

Switch Input. A closure between terminals 4 and 6 will cause the designated relay(s) to activate for the programmed strike time – see 3.2.7. External Postal Switch is connected here, section 1.4.

Microphone Input.

Common for switch input #4, Microphone, Speaker and Standby Battery NEGATIVE.

Speaker Output.

(Not used).

(Not used).

(Not used).

“Z” Button Input. A closure between terminals 11 and 6 will dial the phone number stored under directory code 1, 01, 001 or 0001.

“A” Button Input. A closure between terminals 12 and 6 will dial the phone number stored under directory code 0, 00, 000 or 0000.

Relay 2 Common – 30 Volt, 3 Amp max.

Relay 2 Contact – 30 Volt, 3 Amp max.

Relay 1 Common – 30 Volt, 3 Amp max.

Relay 1 Normally Closed – 30 Volt, 3 Amp max.

Relay 1 Normally Open – 30 Volt, 3 Amp max.

Microphone Power and Standby Battery POSITIVE for Phone System Only (12 VDC, .7 Ah, SLA) (connect negative to terminal 6)

100 ft. max. with 18 AWG wire.

200 ft. max. with 16 AWG wire.

16 VAC Input Power
20 VA min.

Relay 0 Terminal

Non-Removable



Normally Open – 30 Volt, 3 Amp max.
Normally Closed – 30 Volt, 3 Amp max.
Common – 30 Volt, 3 Amp max.

Aux Terminal

Removable

Note: The 14-pin aux terminal can be removed for easy wiring. Expansion boards are connected here when used. See **Expansion Tracker Board Manual** 2358-065 and section 2.3.2, 2.3.3 for more information.

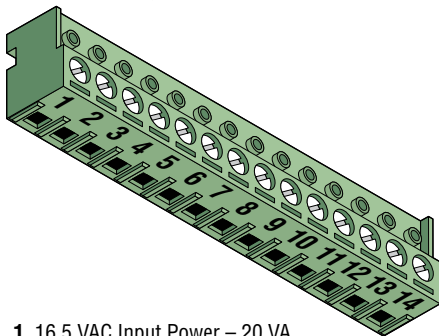

1 16.5 VAC Input Power – 20 VA.
(Powers RS-232, elevator control and Wiegand)

2 16.5 VAC Input Power – 20 VA.

3 Standby Battery POSITIVE (12 VDC, .7 Ah, SLA).

4 Standby Battery NEGATIVE (For Wiegand Only).

5 16 VAC Output. For card readers that have additional lighting for outdoor use.

6 16 VAC Output.

7 DATA 0.

8 DATA 1. 26, 30 and 31 Bit Wiegand input (Card Reader)

9 Common. activates **Relay 2** for programmed strike time

10 +12 VDC Power.

11 DATA 0.

12 DATA 1. 26, 30 and 31 Bit Wiegand input (Card Reader)

13 Common. activates **Relay 1** for programmed strike time

14 +12 VDC Power.

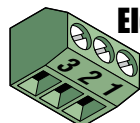

Elevator Control Terminal

Non-Removable

3 COMMON – Connect to terminal 22 of elevator control board.

2 DATA 0 – Connect to terminal 21 of elevator control board.

1 DATA 1 – Connect to terminal 20 of elevator control board.

Note: Connect to the Elevator Control Board (2348-010). See **Elevator Control Board Manual** 2348-065 for more info.

RS-232 Terminal

Removable

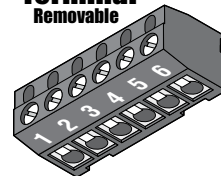

1 Transmit Data

2 Receive Data

3 Request to Send

4 Clear to Send

5 Signal Ground - Shell

6 Not used

Note: Located on the upper right corner of circuit board. The 6-pin terminal can be removed for easy wiring. Connects a PC (See Section 2.5.1).

Main Terminal

Relay 2 Jumper

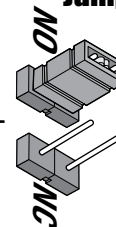

Relay 2 Note: Normally Open and Normally Closed relay jumper is used to set **Relay 2** input on the circuit board (See section 4.3).

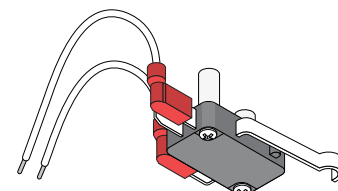

UL 294 Tamper Switch

Note: Located at top of enclosure board (See Section 1.5).

Overview for 1838 Keypad Programming

	Page #	Section	Command	Factory Setting
NOT Programmable from Software. Program from 1838 Keypad ONLY.	Section 3.2 Setup 1838 for PC Programming			
			Master Switch ON	No factory setting
	25	3.2.1		
	26	3.2.4	* 36	007 (7 sec)
	26	3.2.5	* 15	1 (tone ON)
	26	3.2.6	* 85	1 (19200 Baud)
	26	3.2.7	* 18	0 (activates relay)
	27	3.2.8	* 75	1 (Turned ON)
	27	3.2.9	* 04	Single 1838
	27	3.2.10	* 59	Issued by DoorKing
28	3.2.11	* 95	8-3000 Memory 2-Card w/Anti-Pass Back	
28	3.2.12	* 19	OFF	
Testing DKS Data over IP	47	6.1.7	* 56	Testing Option
	47	6.1.8	* 29	Testing Option
	47	6.1.9	* 55	Testing Option OFF
Section 3.3 General Programming using 1838 Keypad				
30	3.3.1	* 03	Relay 0: 01 (1 sec) Relay 1: 01 (1 sec) Relay 2: 01 (1 sec)	
30	3.3.2	* 08	060 (60 sec)	
31	3.3.3	* 05	Relay 0: #### Relay 1: 9 8 7 6 Relay 2: 5 4 3 2	
31	3.3.4	* 50	010 (relay 1 activates)	
32	3.3.5	* 07	Touch-tone	
32	3.3.6	* 51	010 (relay 1 activates)	
Section 3.4 Not Applicable to 1838				
Section 3.5 Programming Phone Numbers				
33	3.5.1	* 20	Three (3) digits	
33	3.5.2	* 01	No factory setting	
34	3.5.3	* 24	No factory setting	
34	3.5.4	* 41	No factory setting	
35	3.5.6	* 01	No factory setting	
35	3.5.8	* 24	No factory setting	
35	3.5.10	* 09	No factory setting	
35	3.5.11	* 27	1 (Pause ON)	
Section 3.6 Programming 5-Digit PIN Device Codes				
36	3.6.1	* 70	No factory setting	
36	3.6.2	* 71	No factory setting	
36	3.6.3	* 72	No factory setting	
36	3.6.4	* 73	No factory setting	
Section 3.7 Programming Four-Digit Entry Codes				
37	3.7.1	* 02	No factory setting	
37	3.7.2	* 02	No factory setting	
37	3.7.3	* 12	No factory setting	
Section 3.8 Anti-Pass Back				
38	3.8.1	* 43	No factory setting	
38	3.8.2	* 45	No factory setting	
38	3.8.3	* 46	No factory setting	
38	3.8.4	* 48	No factory setting	

Note: Program section numbers have been intentionally skipped that **DO NOT** apply to the specific access controller in this manual. This allows **ALL** of the 1830 series manuals (1834-065 rev H or higher and 1835-065) to remain in sync with each other when referencing programming numbers.

SPECIFICATIONS

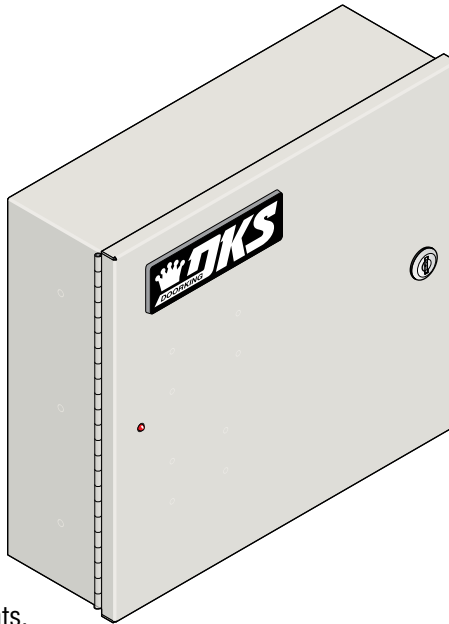

Features

- Can provide service for up to 3000 residents.
- Can store up to 8000 card, transmitter or digital PIN codes.
- System can be connected via a Cellular connection using DKS Cellular Services; via the Internet using DKS Data over the Internet Services for VoIP and/or programming; POTS (Plain Old Telephone Service) using DKS IM Server or your own modem - Note: DKS does not guarantee modem connections via the PSTN (Public Switched telephone Network).
- DKS Cellular Network (requires 1800-080 voice/data cellular system add-on).
use of the DKS Cellular Network is fee based. Visit <https://dksdb.dksoftware.com/NewUserRegChoice.aspx> for more info.
- Directory codes can be set from 1 to 4 digits in length and can be randomly assigned.
- Transaction buffer stores the last 8000 events and has its own backup power source to retain memory during power outage.
- View the LIVE transactions “real-time” on a PC.
- Control the access controller relays directly from a PC (Rev Z and higher boards only).
- 31-security levels total (security level 00 always denies entry, security level 01 always admits entry), with 29 programmable security levels, each with four time zones allows you to control and restrict user access as needed.
- Programmable holiday schedule.
- Facility codes can be enabled or disabled. Store up to 10 different facility codes.
- True Anti-Pass Back feature.
- Up to 255 programmable area codes (Rev E and higher boards only) allow the 1838 to be used in areas requiring 10 and 11-digit dialing.
- Three internal relays allow the 1838 to control a main entry point plus two additional entry points.
- System can be expanded to control up to 48 entry points in addition to the main entry point. Expansion boards are required (one for each additional entry point) and are not included with the 1838. Expansion boards also provide output for door ajar and forced entry alarms.
- Optional elevator control board(s) can control up to four elevators with each elevator serving up to 64 floors.
- 1838 will interface with selected models of DKS DoorKing vehicular gate operators to provide gate operator information and data (requires a Expansion board for each gate operator that is to send data to the 1838).

**Included with the system is an extra random keyed cabinet lock. If desired, for added security against unauthorized entry into the system, the standard lock may be replaced with the random lock.
Note: DoorKing cannot replace this specific lock or keys if lost.**

DoorKing, Inc. reserves the right to make changes in the products described in this manual without notice and without obligation of DoorKing, Inc. to notify any persons of any such revisions or changes. Additionally, DoorKing, Inc. makes no representations or warranties with respect to this manual. This manual is copyrighted, all rights reserved. No portion of this manual may be copied, reproduced, translated, or reduced to any electronic medium without prior written consent from DoorKing, Inc.

TABLE OF CONTENTS

Quick Guide Terminal Descriptions	Quick Guide - 1
Overview for System Keypad Programming	Quick Guide - 2
Important Notices FCC - United States, DOC - Canada Glossary	3
General Information Installation Guidelines and Safety Information	4

SPECIFICATIONS Previous Page

SECTION 1 - INSTALLATION 5

1.1 General Installation	5
1.1.1 Remove Circuit Board from Enclosure	6
1.2.1 Install Enclosure	6
1.2 Mounting Dimensions	7
1.3 Memory Chip Replacement	8
1.4 Postal Lock Installation	9
1.5 UL 294 Compliant Tamper Switch	10

SECTION 2 - WIRING 11

2.1 Wiring Guidelines	11
2.1.1 Power	11
2.1.2 Wire Runs	11
2.1.3 Grounding	12
2.1.4 Surge Suppression	12
2.1.5 Expansion Boards and Elevator Control	12
2.1.6 Ferrite Filter	12
2.2 Terminal Descriptions	13
2.3 Access Controller Circuit Board Wiring	14
2.3.1 NO Tracker Expansion Boards, Remote Call or Intercom Stations	14
2.3.2 Tracker Expansion Boards (HARDWired)	15
2.3.3 Tracker Expansion Boards using 900 MHz Wireless Communication	16
2.3.4 1838 Wiring to ONE 1838-120 or 1838-121 Remote Call Station	17
2.3.5 1838 Wiring to TWO 1838-120 or 1838-121 Remote Call Stations	18
2.3.6 1838 Wiring to a 1504-120 or 1504-121 Intercom Station	19
2.4 PC (Data) and Phone (Voice) Connection Options	20
2.4.1 DoorKing Cellular Network Connection - Data Transfer/Optional Voice	20
2.4.2a DoorKing VoIP/RS-232 Control Box - Data Transfer/Optional Voice	21
2.4.2b DoorKing VoIP Internet Connection - Data Transfer/Optional Voice	21
2.4.2c Third Party VoIP Internet Connection - Data Transfer/Optional Voice	21
2.4.3a DoorKing IM Server Modem Connection - Data Transfer/Optional Voice	22
2.4.3b Dial-Up Phone Modem Connection - Data Transfer/Optional Voice	22
2.5 Direct Connection to PC Options - Data Transfer ONLY	23
2.5.1 RS-232 Direct Connection - Data Transfer ONLY	23
2.5.2 RS-422/USB Direct Connection to PC - Data Transfer ONLY	23
2.5.3 TCP/IP Converter Direct Connection to PC - Data Transfer ONLY	23

SECTION 3 - PROGRAMMING 24

3.1 General Programming Information	24
3.1.1 Programming from a PC	24
3.1.2 Programming from the 1838 Keypad	24
3.2 Setup 1838 for PC Programming	25
3.2.1 Master Code	25
3.2.4 Resident Elevator Button Relay Time	26
3.2.5 "Tone Open" Sound ON or OFF	26
3.2.6 RS-232 Speed Setting	26
3.2.7 Switch Input Feature	26
3.2.8 Elevator Control Feature	27
3.2.9 Single or Multiple Systems	27
3.2.10 DKS Data over IP Phone Number or System ID Number	27
3.2.11 Re-Program Memory Size, with/without Cards and Anti-Pass Back	28
3.2.12 Live Transactions Viewing on a PC - ON or OFF	28
Overview for System Keypad Programming	29

NOT Programmable from Software. Program from 1838 Keypad ONLY.

TABLE OF CONTENTS

1838 Keypad Programming when NOT using a PC

3.3 General Programming using the 1838 Keypad		30
3.3.1 Relay Strike Time		39
3.3.2 Talk Time		30
3.3.3 Tone Open Numbers		31
3.3.4 Switch Input Relay(s) Activation		31
3.3.5 Touch-Tone / Rotary-Dial		31
3.3.6 Rotary-Dial 9 Relay(s) Activation		32
3.5 Programming Phone Numbers		33
3.5.1 Programming the Directory Code Length		33
3.5.2 Programming Directory Codes with 7-Digit Phone Number - NO Area Code		33
3.5.3 Programming Area Codes		34
3.5.4 Programming Directory Codes with Phone Numbers that use Area Codes		34
3.5.6 Deleting Individual Phone Numbers		35
3.5.8 Delete Area Codes		35
3.5.10 PBX Line Access Code Programming		35
3.5.11 Touch-Tone Dial Pause		35
3.6 Programming 5-Digit PIN Device Codes		36
3.6.1 Programming Five-Digit Device Codes		36
3.6.2 Deleting Device Codes		36
3.6.3 Enabling Facility Codes		36
3.6.4 Programming Facility Codes		36
3.7 Programming Four-Digit Entry Codes		37
3.7.1 Programming Four-Digit Entry Codes		37
3.7.2 Delete Entry Codes		37
3.7.3 Entry Code Ranges		37
3.8 Anti-Pass Back		38
3.8.1 Programming the Anti-Pass Back Mode		38
3.8.2 Re-Sync All Devices		38
3.8.3 Re-Sync Individual Devices		38
3.8.4 Reset Facility Counter		38

SECTION 4 - ADJUSTMENTS **39**

4.1 Master Code Switch		39
4.2 Ring Pin Jumper		39
4.3 Relay 2 Jumper		40
4.4 Speaker Volume, Microphone and Feedback		40

SECTION 5 - OPERATING INSTRUCTIONS **41**

5.1 User Instructions		41
5.2 System Administrator		42
5.2.1 Connecting to the Access Controller from a Remote Location		42
5.2.2 Expansion Board Override HOLD OPEN Command		42
5.2.3 Relay Check		42
5.2.4 Control Relays Directly from a PC		42

SECTION 6 - MAINTENANCE **43**

6.1 Troubleshooting		43-44
6.1.1 RS-232 Test		45
6.1.2 Wiegand Test - Optional LCD Display MUST be Installed		45
6.1.3 Elevator Control Board(s) Hardware Test - Optional LCD Display MUST be Installed		45
6.1.4 Elevator Board / Floor Hardware Test - Optional LCD Display MUST be Installed		46
6.1.5 Automatic Hang-up Options - Optional LCD Display MUST be Installed		46
6.1.6 Modem Output Level Adjustment		46
6.1.7 Display DKS Data over IP Phone Number or System ID Number - Optional LCD Display MUST be Installed		47
6.1.8 Test Connection to DKS Data over IP - Optional LCD Display MUST be Installed		47
6.1.9 Turn DKS Data over IP ON or OFF		47
6.2 Accessories		48
1838 Wiring Schematic		49

SECTION 7 - LOG TABLES **50**

7.1 Programming Information Tables		50
7.1.1 10 Area Codes		50
7.1.2 255 Area Codes		51-52
7.2 Resident Information		53

RESIDENT INSTRUCTION SHEET **54**

Important Notices

FCC – United States

This equipment has been tested and found to comply with the limits for a class A digital device, pursuant to Part 15 of the FCC Rules and Regulations. These limits are designed to provide reasonable protection against harmful interference when the equipment is operated in a commercial environment. This equipment generates, uses, and can radiate radio frequency energy and, if not installed and used in accordance with the instruction manual, may cause harmful interference to radio communications. Operation of this equipment in a residential area is likely to cause harmful interference in which case the user will be required to correct the interference at his own expense.

FCC Registration Number: **DUF6VT-12874-0T-T**

DOC - Canada

The Canadian Department of Communications label identifies certified equipment. This certification means that the equipment meets certain telecommunications network protective, operational, and safety requirements. The Department does not guarantee the equipment will operate to the users satisfaction.

Before installing this equipment, users should ensure that it is permissible to be connected to the facilities of the local telecommunications company. The equipment must also be installed using an acceptable means of connection. The customer should be aware that compliance with the above conditions may not prevent degradation of service in some situations.

Repairs to certified equipment should be made by an authorized Canadian maintenance facility designated by the supplier. Any repairs or alterations made by the user to this equipment, or equipment malfunctions, may give the telecommunications company cause to request the user to disconnect the equipment.

Users should ensure, for their own protection, that the electrical ground connections of the power utility, telephone lines, and internal metallic water pipe system, if present, are connected together. This precaution may be particularly important in rural areas.

CAUTION: Users should not attempt to make such connections themselves, but should contact the appropriate electric inspection authority, or electrician, as appropriate.

DOC Registration Number: **1736 4507 A**

Notice:

The Load Number (LN) assigned to each terminal device denotes the percentage of the total load to be connected to a telephone loop which is used by the device, to prevent overloading. The termination on a loop may consist of any combination of devices subject only to the requirement that the sum of the load numbers of all the devices does not exceed 100.

Notice:

DoorKing does not provide a power transformer on units sold outside of the United States. Use only transformers that are listed by a recognized testing laboratory to power the telephone entry system. **An Inherently Protected Transformer must be used to power this device.** 1838 system requires a 16.5-volt, 20 VA transformer.

Listing:

This product has been tested to and found to be in compliance with the UL 294 Safety Standard and Certified to CAN/ULC-S319-05 by Intertek Testing Services NA Inc. (a Nationally Recognized Testing Laboratory) and is ETL listed.

Performance Levels

Destructive Attack:	Level I
Line Security:	Level I
Endurance:	Level IV
Standby Power:	Level I (Level II with 12 VDC, .7 Ah, SLA battery, required
Single Point Locking Device with Key Locks:	Level I for Canadian certification)

Glossary

ACCESS CONTROL SYSTEM: A collection of means, measures and specific practices that when combined, form or compose a systematic approach, which enables an authority to control access to areas and resources in a given physical facility. An access control system, within the field of physical security, is generally seen as the second layer in the security of a physical structure.

ALARM: A condition indicating a state of alert or tamper detection.

ALARM SIGNAL: A transmission of an alarm condition or alarm report.

CONTROLLED AREA: A room, office, building, facility, premises, or grounds to which access is monitored, limited, or controlled.

EQUIPMENT: Any part of an electronic access control system, such as access control units, reader interface modules, access point actuators, access point sensors, keypads, and the like.

PROTECTED AREA: A room, office, building, facility, premise or grounds to which access is monitored, and limited and/or controlled, whereby the authorized person of the Access Control System may grant access to non-authorized persons.

RESTRICTED AREA: A room, office, building, facility, premise or grounds to which access is monitored, and limited and strictly controlled, whereby only the administrator of the Access Control System shall issue credentials that will lead to access.

General Information

- Prior to beginning the installation of the telephone entry system, we suggest that you become familiar with the instructions, illustrations, and wiring guidelines in this manual. This will help insure that you installation is performed in an efficient and professional manner.
- The proper installation of the telephone entry panel is an extremely important and integral part of the overall access control system. Check all local building ordinances and building codes prior to installing this system. Be sure your installation is in compliance with local codes.
- When used to control a door or pedestrian gate, try to locate the telephone entry system as near as possible to the entry point. The unit should be mounted on a rigid wall to prevent excessive shock and vibration from closing doors or gates. Continuous vibration and shock from slamming doors or spring-loaded pedestrian gates will damage the circuit board. **Under no circumstances should the unit be mounted directly to a moving door or gate.**
- **ADA mounting requirements for door control (Ref: ICC/ANSI A117.1-2009).** The requirements below apply **ONLY** when the telephone entry system is being used to control entry through **A PUBLIC DOOR ONLY**. If this system is used to control entry through a **vehicular gate** or **private entrance**, the dimensions noted below **do not apply**.

1. Unobstructed Forward Reach. Where a clear floor or ground space allows only a forward approach to an object and is **unobstructed**, mounting height shall be a minimum of **15 inches** (381 mm), and a maximum of **48 inches** (1.22 m), above the floor or ground to the operable controls.

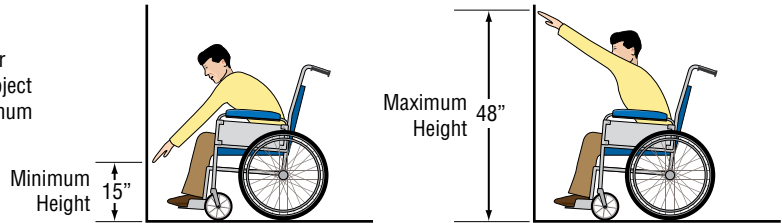

2. OBSTRUCTED HIGH Forward Reach. If the high forward reach is over an obstruction, reach and clearances shall be as shown. **NOTE: If the height of a control is 48" maximum, then the length of the obstruction must be 20" or less. If the height of a control is 44" maximum, then the length of the obstruction may be increased to 25" or less.**

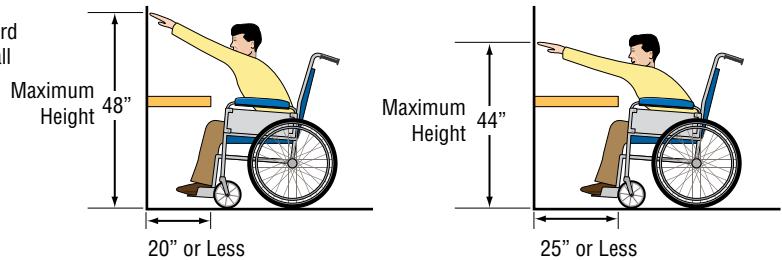

3. Unobstructed Side Reach. Where a clear floor or ground space allows a parallel approach to an object and the side reach is **unobstructed**, and the edge of the clear floor space is **10 inches** (255 mm) maximum from the object, mounting height shall be a minimum of **15 inches** (380 mm), and a maximum of **48 inches** (1.22 m), above the floor or ground to the operable controls.

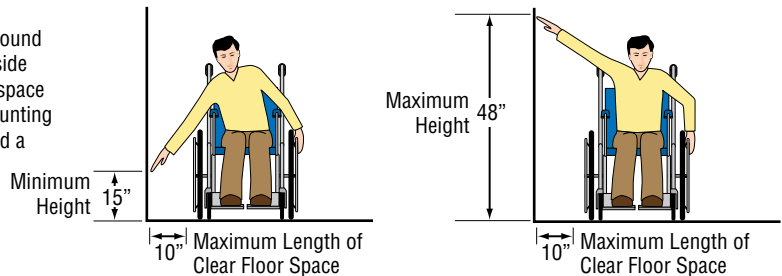

4. OBSTRUCTED HIGH Side Reach. If the side reach is over an obstruction **10 inches or less**, mounting height shall be a maximum of **48 inches** (1.21 m) above the floor or ground to the operable controls. If the side reach is over an obstruction **greater than 10 inches, but less than 24 inches**, mounting height shall be a maximum of **46 inches** (1.17 m) above the floor or ground to the operable controls.

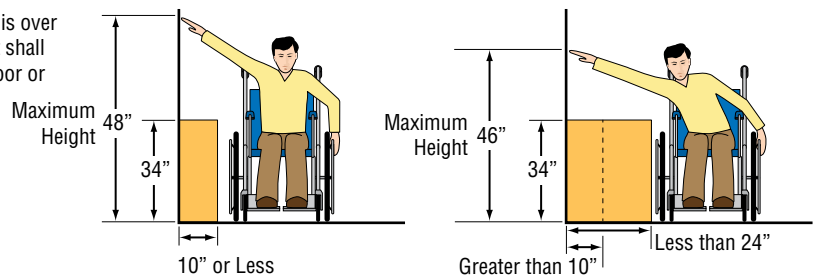

- **When used to control a vehicular gate with an automatic gate operator, the telephone entry system must be mounted a minimum of six (6) feet away from the gate and gate operator, or in such a way that a person cannot operate the entry system and/or touch the gate or gate operator at the same time.**
- Be sure that the system is installed so that it is not directly in the traffic lane. Goose neck mounting post and kiosks work well for these type systems. When planning where to locate the system, take into consideration traffic lane layouts, turn around lanes for rejected access, conduit runs, power availability, etc.
- Environmental factors must also be taken into account. Surface mount units are designed for direct outdoor installations, however it is preferable to protect them from direct exposure to driven rain or snow whenever possible. Flush mount units must be protected from direct exposure to the elements.
- This telephone entry system contains a number of static sensitive components that can be damaged or destroyed by static discharges during installation or use. Discharge any static prior to removing the circuit board from the lobby panel by touching a proper ground device.
- **Instruct the end user to read and follow these instructions. Instruct the end user to never let children play with or operate any access control device. This Owner's Manual is the property of the end user and must be left with them when installation is complete.**

SECTION 1 - INSTALLATION

Prior to installing the 1838, we suggest that you become familiar with the instructions, illustrations, and wiring guidelines in this manual. This will help insure that you installation is performed in an efficient and professional manner.

If using a standard copper wire telephone line connection, order your phone line to be installed at least two weeks prior to the planned 1838 installation date. This will assure that a phone line is available when the unit is installed. The telephone company will require the following information from you:

Type:	Touch Tone, Loop Start
Ringer Equivalence:	0.0 A
Jack Type:	RJ11C
FCC Registration (US):	DUF6VT-12874-OT-T
DOC (Canada):	1736 4528 A

Caller ID: You may want to order **caller ID blocking** from the telephone company for the entry system phone line. Without caller ID blocking, residents with the proper phone equipment **WILL BE ABLE** to identify the telephone number that the 1838 is installed on. This may or **MAY NOT** be desirable.

Call Waiting: Residents may order call waiting from their local telephone company **AFTER** the system has been installed. They can avoid missing calls coming from the 1838 while they are using their phone (No busy signal).

1.1 General Installation

Mount on a surface, indoors or outdoors. **DO NOT** make any new holes in the enclosure to feed wires through. Keep **ALL** the access controller's wires away from any existing high voltage power wires a minimum of 18" to help prevent any noise and hum pickup in the 1838's phone line if used. The 1838 **MUST** also be **properly grounded** to function correctly.

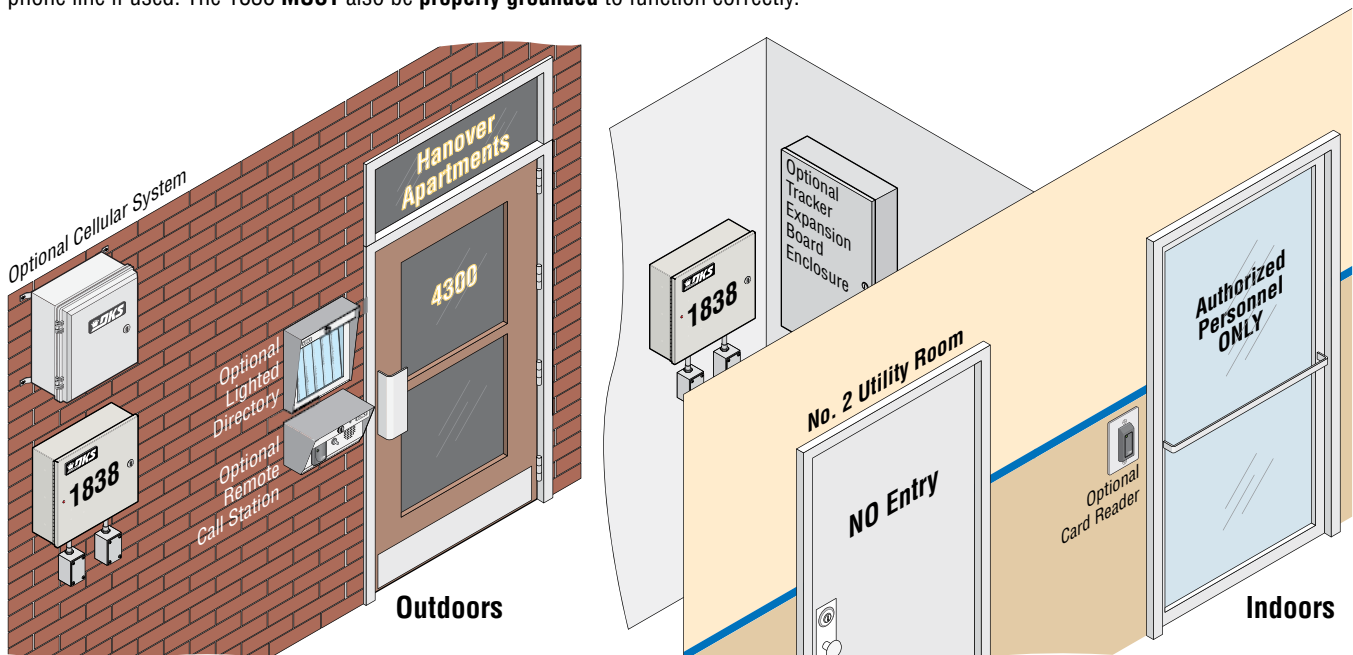

WARNING If this multi-door access controller is used to control a vehicular gate with an automatic gate operator, the access controller must be mounted a minimum of six (6) feet away from the gate and gate operator, or in such a way that the user cannot come into contact with the gate or gate operator when using this access controller .

The multi-door access controller contains static sensitive components that can be damaged or destroyed by static discharges during installation. **Discharge any static prior to removing the circuit board by touching a proper ground device.** GREAT care must be taken after removing the circuit board from the enclosure to protect it throughout the installation. Carelessness on your part is **NOT** covered under warranty.

Make sure **ALL** dirt, metal or wood debris is removed from inside the enclosure after mounting it. A thorough cleaning of the enclosure is needed before re-installing the circuit board back into the system and wiring it. Any debris left inside could damage the control board and cause the access controller to malfunction during operation.

Included with the system is an extra random keyed cabinet lock. If desired, for added security against unauthorized entry into the system, the standard lock may be replaced with the random lock. Note: DoorKing cannot replace this specific lock or keys if lost.

1.1.1 Remove Circuit Board from Enclosure

1. Disconnect the ribbon cable from the circuit board
2. Remove the two screws from right side of the circuit board.
3. **GENTLY** remove the circuit board by pulling it out of the main terminal. Store board in a **Safe Place** until it needs to be re-installed.

Discharge any static BEFORE removing the circuit board by touching a proper ground device.

Note: Enclosure door not shown in illustration to better clarify board removal.

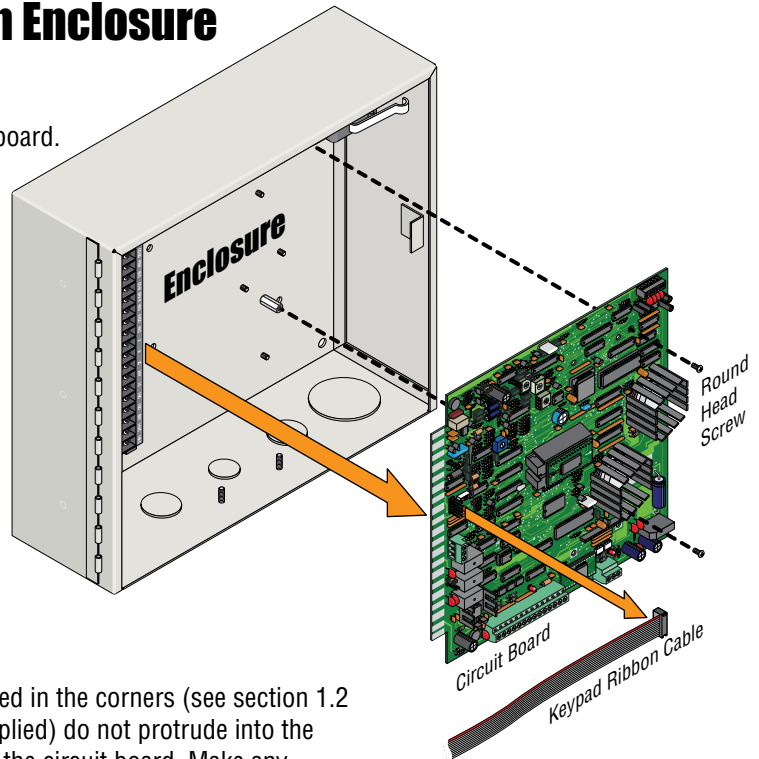

1.1.2 Install Enclosure

1. Mount the enclosure using the mounting holes provided in the corners (see section 1.2 for dimensions). Be sure that mounting screws (Not supplied) do not protrude into the enclosure where they could cause a short on the back of the circuit board. Make any necessary conduit connections through the bottom of the enclosure using the existing conduit knock-outs. **DO NOT** make any new conduit holes in the enclosure.
2. Route all wiring through conduit into enclosure.
3. Clean out the enclosure. Make sure that all dirt, metal and/or wood debris is removed.
4. Re-install circuit board back into the enclosure (Reverse section 1.1.1 steps). Use the wiring schematics in the back of this manual to help re-install the circuit board if necessary. **DO NOT** apply any power at this time.

Use appropriate hardware to secure enclosure to the surface (not supplied).

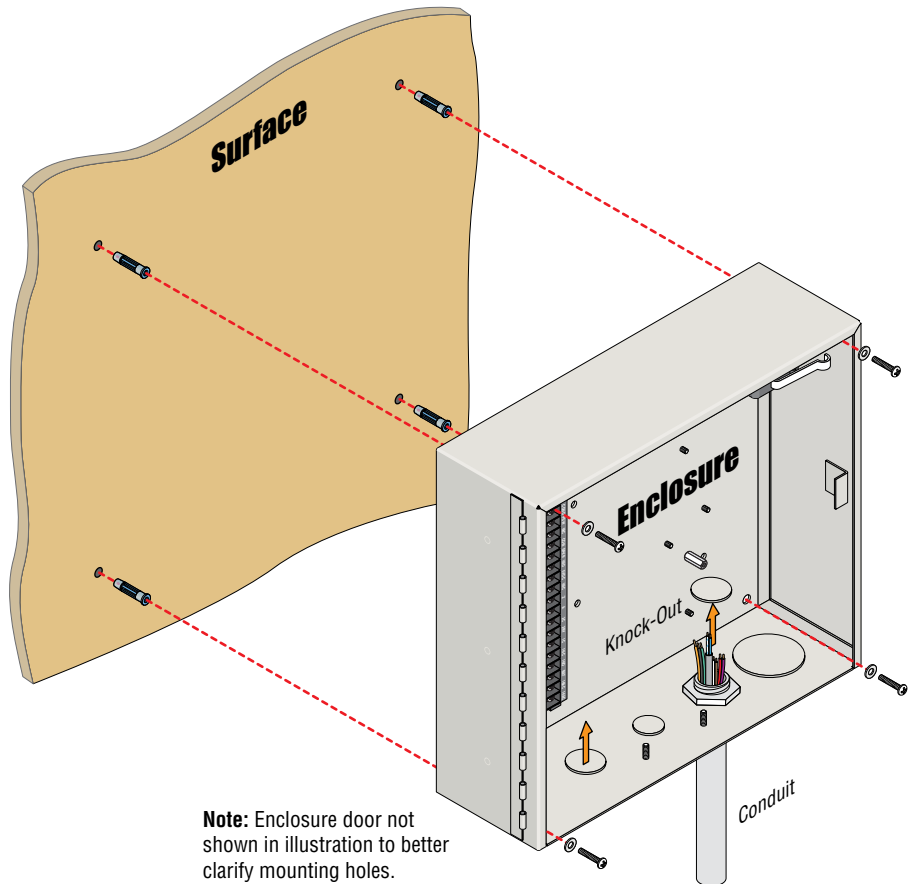

Note: Enclosure door not shown in illustration to better clarify mounting holes.

1.2 Mounting Dimensions

If used to control a door or pedestrian gate, try to locate the access controller as close as possible to the entry point. The unit should be mounted on a rigid wall to prevent excessive shock and vibration from closing doors or gates. Continuous vibration and shock from slamming doors or spring-loaded pedestrian gates will damage the circuit board. **Under no circumstances should the unit be mounted directly to a moving door or gate.**

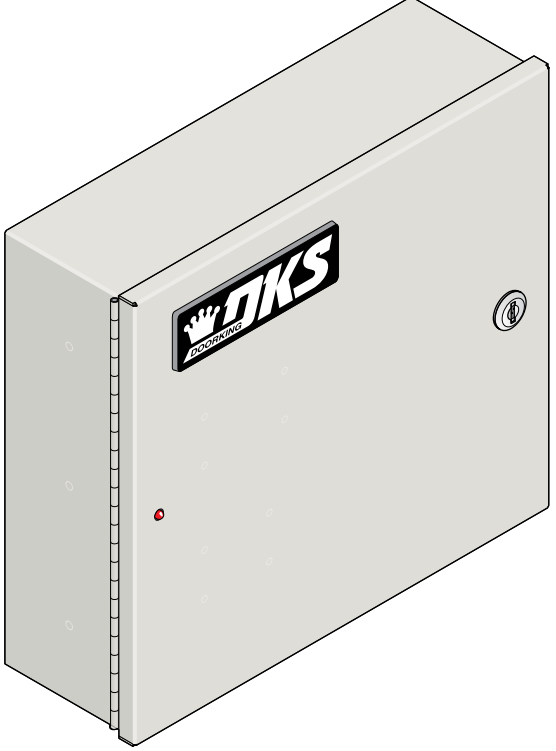

Back View

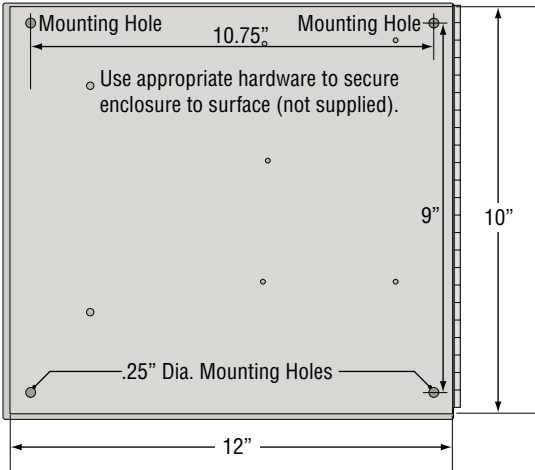

Side View

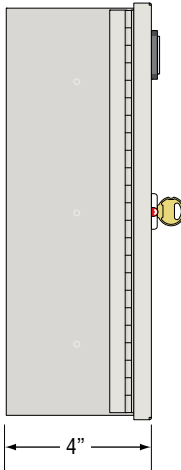

Front View

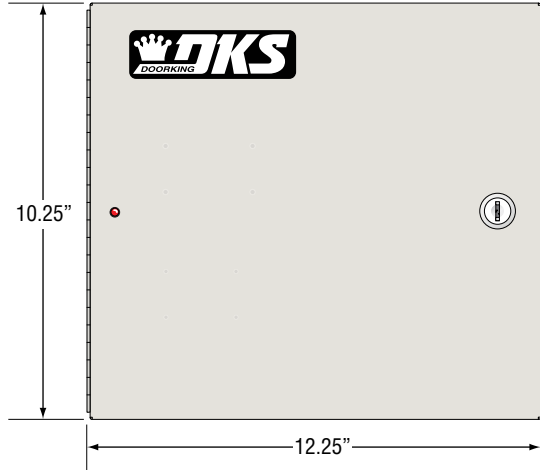

WARNING! If this entry system is used to control a vehicular gate with an automatic gate operator, the entry system must be mounted a minimum of six (6) feet away from the gate and gate operator, or in such a way that a person cannot operate the entry system and touch the gate or gate operator at the same time.

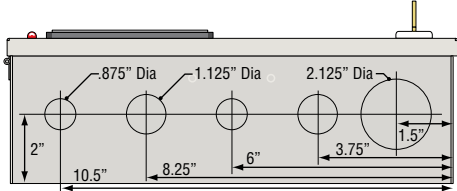

Bottom View

1.3 Memory Chip Replacement

The 1838 access controller is shipped with the memory chip already installed in the unit. However, if you need to replace the memory chip in the NEW 1838 access controller or replace the memory chips in an OLDER 1838, follow the instructions below.

⚠ CAUTION

DO NOT install the memory chip with power to the telephone entry system turned ON. Attempting to install the memory chip with power on will irrevocably damage the chip. The memory chip is a static sensitive component. **Discharge any static electricity from your hands by touching a proper ground device before touching the control board.** Handle the memory chip with care, the pins can bend easily.

DO NOT install the memory chip UPSIDE-DOWN (Arrow MUST point in direction shown). Installing chip upside-down will cause permanent damage to the chip.

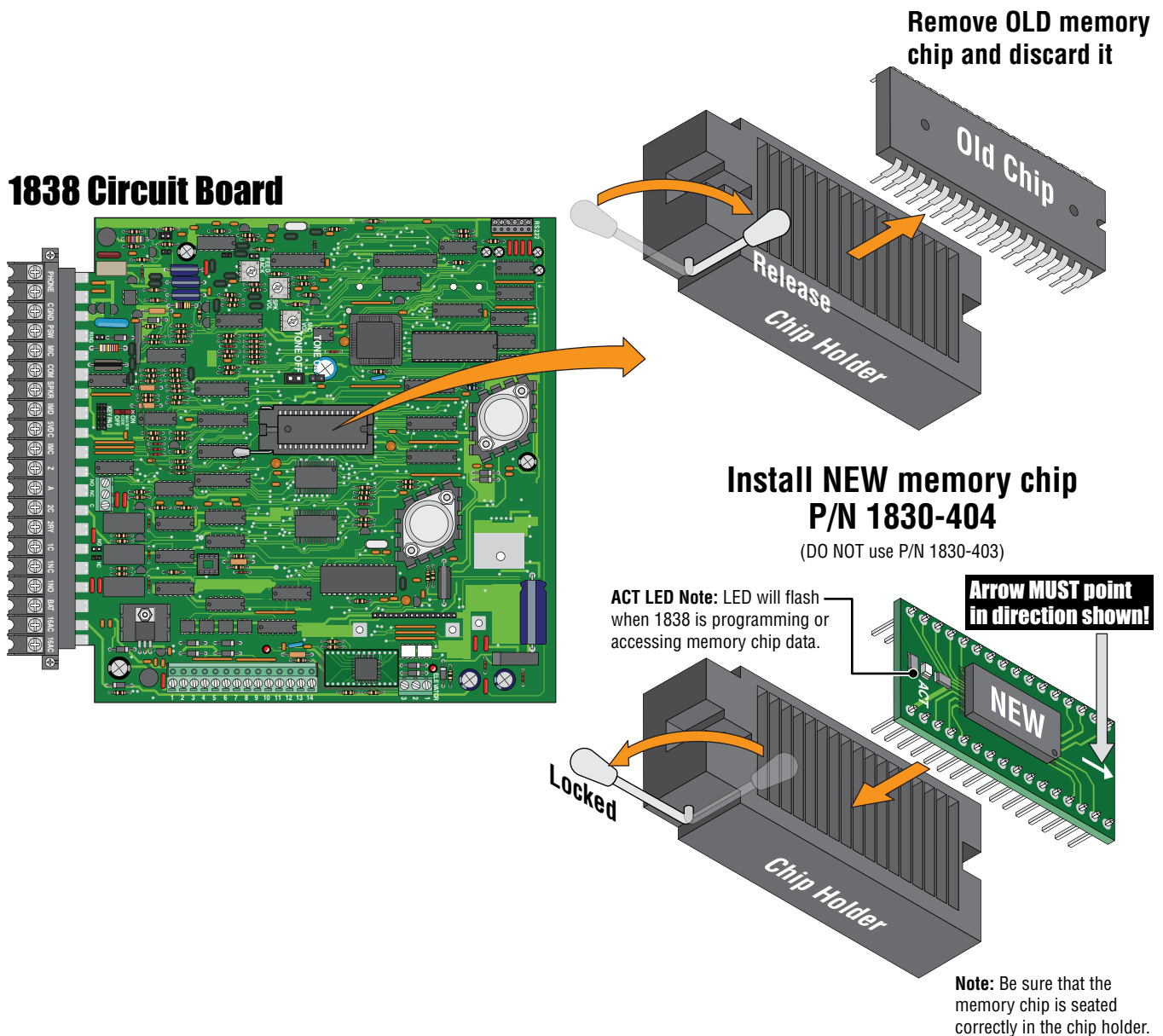

1.4 Postal Lock Installation

At some locations, such as gated communities, it will be necessary to **provide access to the mail carrier** so that they can deliver the mail. Mail carrier access will be provided by the installation of an **Arrow Postal Lock** into a DoorKing Postal Lock Box sold separately (P/N 1402-080). This is the same lock that the Post Office uses for gang mailboxes. **These locks are not available to the public.** The installer or the building owner/manager will have to call the Post Office and arrange for the installation of this lock into the DoorKing Postal Lock Box which is wired to the 1838 main terminal.

Prior to installation of the postal lock, be sure power to the 1838 is **turned OFF.**

DoorKing Postal Lock Box

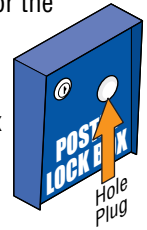

1. Remove the hole plug on the faceplate of the Postal Lock Box.
2. Cut the wire tie wrapped around the switch.
3. Remove the two hex nuts from the postal lock-mounting studs. Mount arrow lock on the studs and secure with the hex nuts.
4. Connect **COMMON** and the **NORMALLY CLOSED** switch contacts to main terminals 4 and 6 in the 1838.

When the lock is installed, the pawl of the lock, in the **extended position** is **depressing the switch**. When the mail carrier inserts his key and turns the postal lock, the pawl is **withdrawn into the lock** and the switch will activate the relay for the programmed strike time, that has been programmed for this feature.

Factory default settings for the Postal Lock Switch: After the key has been turned, **Relay 1** will activate (section 3.3.4) for **One (1) second** of strike time (section 3.3.1). The switch input feature (section 3.2.7) is factory set to “activate a relay”.

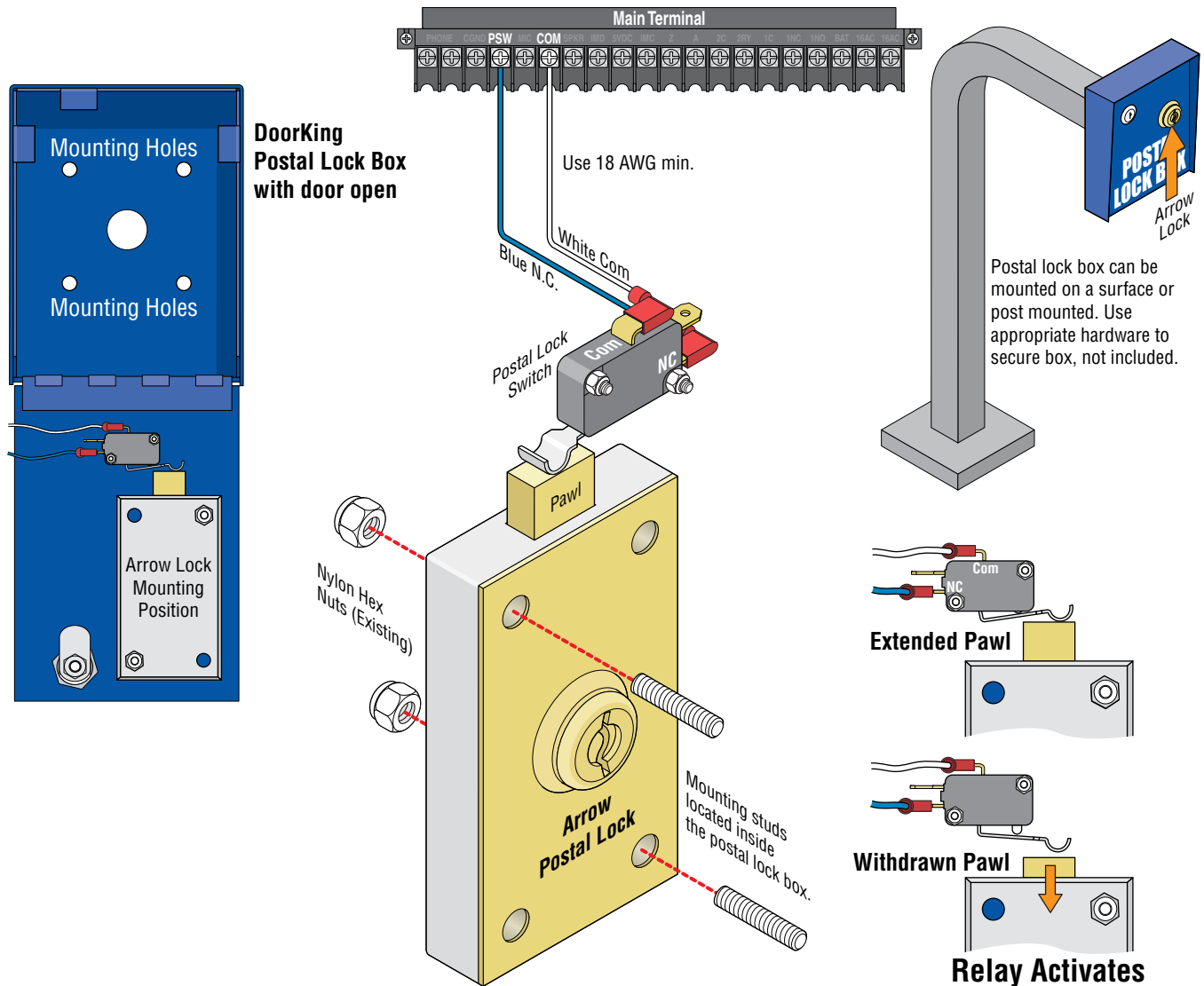

1.5 UL 294 Compliant Tamper Switch

The tamper switch needs to be connected to a security device or existing security system to comply with the UL 294 standard. Connect the 2 white wires of the **Normally Closed** gravity activated dry contact tamper switch to whatever security setup you desire. The gravity switch gets **activated** when the faceplate is **opened**. Repair and maintenance technicians may need to notify the proper authorities **BEFORE** opening the entry system faceplate, depending on how your security of this system has been setup.

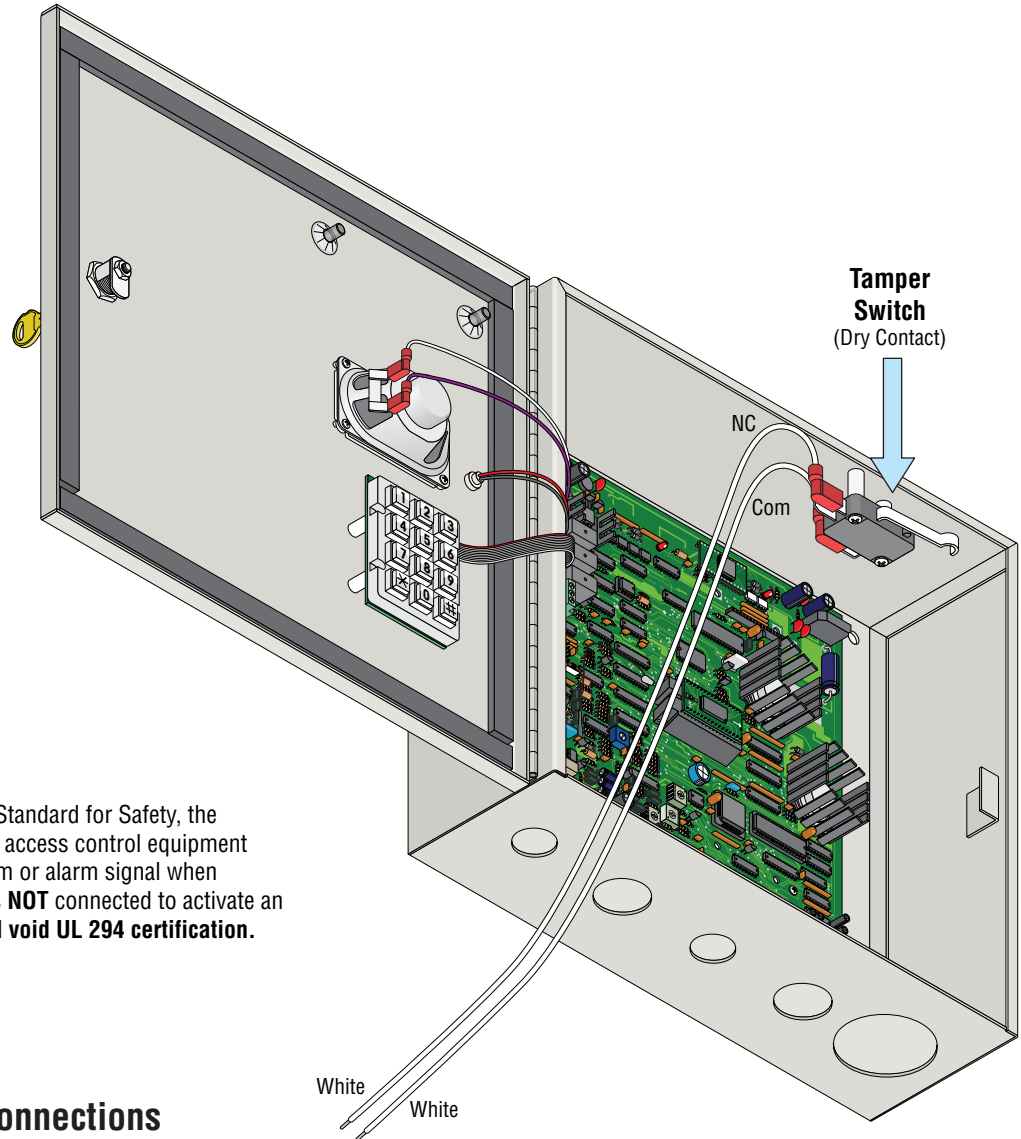

Note: To comply with UL 294 Standard for Safety, the tamper switch provided in this access control equipment must be set to activate an alarm or alarm signal when tripped. If the tamper switch is **NOT** connected to activate an alarm or alarm signal, **this will void UL 294 certification.**

Possible Security Connections

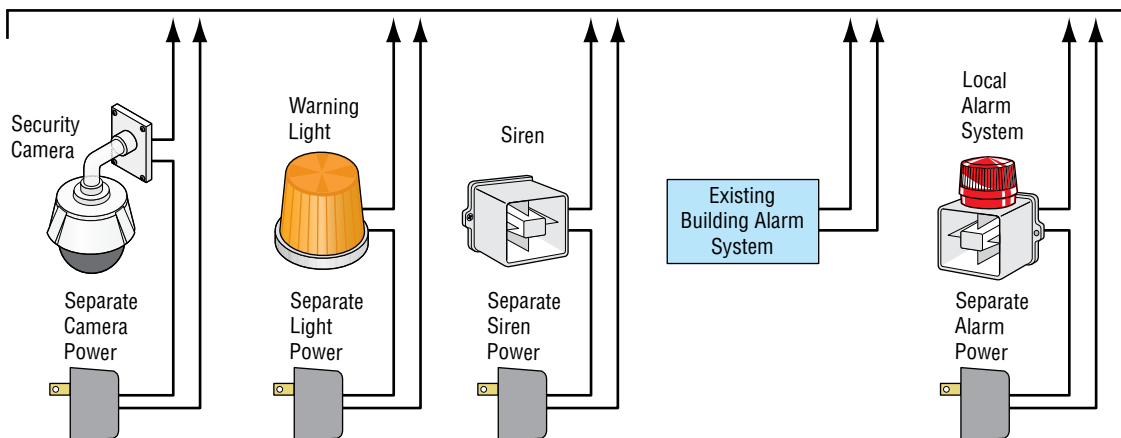

SECTION 2 - WIRING

Prior to installing wiring to the 1838, we suggest that you become familiar with the instructions, illustrations, and wiring guidelines in this manual. This will help insure that your installation is performed in an efficient and professional manner. Wiring the access controller panel is an extremely important and integral part of the overall access control system. Use proper wire for the communication line, power wires, and be sure that the system is properly grounded. Check all local building ordinances and building codes prior to installing this system. Be sure your installation is in compliance with local codes. Telcom Access Standards. It is not permissible for customers to use the telcom network lead-in cable to provide the intercom function between the gate and the house. New Zealand Customers: All door and gate entry systems wiring must comply with PTC106: March 2008, Section 9.

WARNING If this access controller is used to control a vehicular gate with an automatic gate operator, the access controller must be mounted a minimum of six (6) feet away from the gate and gate operator, or in such a way that the user cannot come into contact with the gate or gate operator when using this controller. If this unit has been installed closer to the automated vehicular gate, do not proceed with any wiring until the unit has been moved and re-installed so that it is in compliance with these instructions.

The 1838 contains a number of static sensitive components that can be damaged or destroyed by static discharges during installation or use. **Discharge any static prior to removing the circuit board from the enclosure by touching a proper ground device.**

2.1 Wiring Guidelines

2.1.1 Power

Use only the two (2) supplied transformers (or UL listed equivalent) to power the access controller and any 26, 30 and 31 Bit Wiegand input devices that use 16.5 VAC, 20 VA. **DO NOT power any other devices (expansion boards, electric strikes, magnetic locks etc.) from these power transformers.**

Note: Transformers are not supplied on units sold outside the United States. An Inherently Protected Transformer must be used to power this device. Use only transformers that are listed by a recognized testing laboratory to power the access controller.

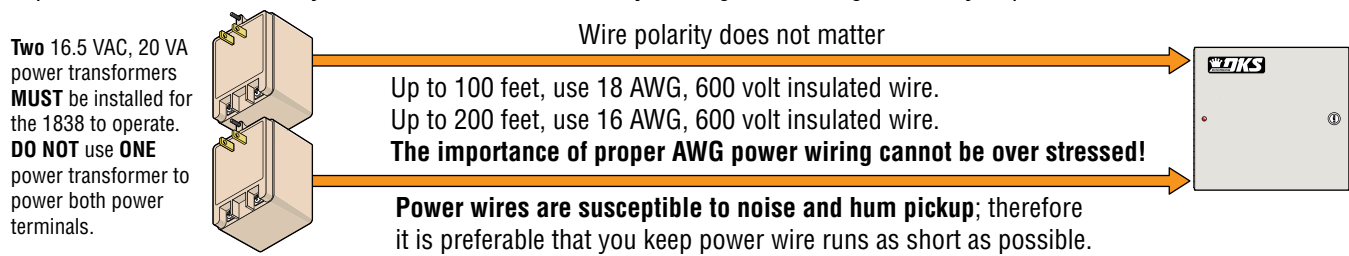

Do Not Connect To A Receptacle Controlled By A Switch.

“Optional” 12 volt .8 amp hour gel-cell batteries (DoorKing P/N 1801-008) can be installed to **provide stand-by power in the event of a power outage.** Two batteries are required, one for the phone system power and one for the auxiliary terminal power.

2.1.2 Wire Runs

Be sure that you use proper wire that has an insulation rated for an underground environment. **All wires should be placed in conduits.** Proper pre-planning can greatly ease the installation and wiring of this system. Always check with the local building code to determine the type of wire required in your municipality.

DO NOT run high voltage (115 V) power lines and low voltage/communication lines in the same conduit. These should be in separate conduits at least 18 inches apart. Be sure that all phone line wiring is twisted and completely isolated from ground.

Wiegand wire runs are 500-foot maximum. Use 6-conductor stranded wire with overall shield. 18, 20, 22 or 24 gauge is sufficient for these connections.

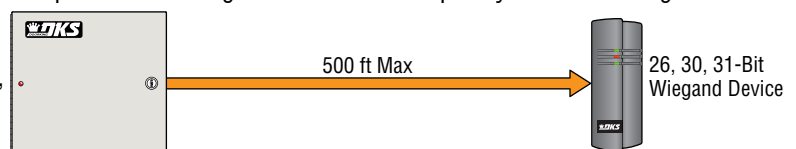
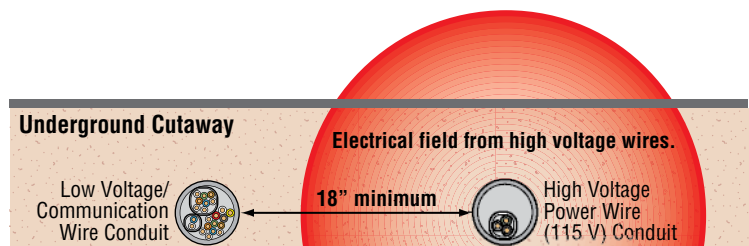

2.1.3 Grounding

Proper grounding of this system is a requirement. To be effective, ground connections should be made with a minimum 12 AWG, 600 volt insulated wire to a ground point within 10 feet of the access controller. The ground point must be at an electrical panel, a metallic cold water pipe that runs in the earth, or a stainless steel grounding rod driven at least ten (10) feet into the soil. **A architectural style mounting post anchored to concrete does NOT make a good ground.**

Some Acceptable Ground Sources

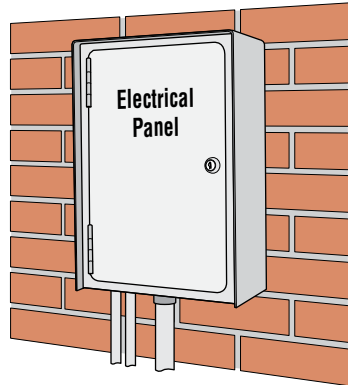

Ground to an existing electrical system.

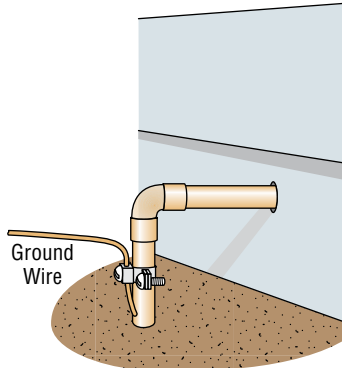

Ground to a metallic cold water pipe.

IMPORTANT: Ground wire shown without safety protection for clarity. Make sure ground wire is protected from being touched or electrical shock could occur!

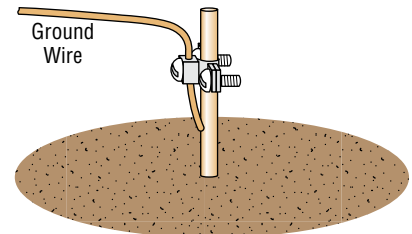

Grounding rod 10 feet in soil.

2.1.4 Surge Suppression

The use of surge suppressors can significantly reduce the chance of component failure because of static charges or surges. DoorKing recommends installing a **Phone Line** surge suppressor (DoorKing P/N 1877-010 or equivalent) and a **Low Voltage** surge suppressor (DoorKing P/N 1878-010 or equivalent) to help protect the entry system from power surges.

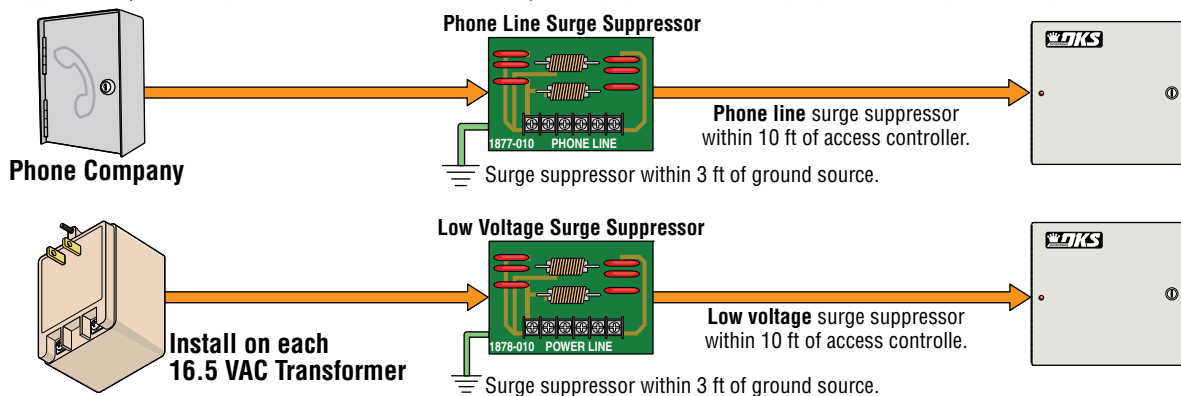

2.1.5 Expansion Boards and Elevator Control

If **Expansion Boards** are being used with this access controller, refer to the Installation and Wiring manual that came with the Expansion boards, for detailed information on wiring Expansion boards to the PC programmable multi-door access controller.

If **Elevator Control** is used with this system, refer to the Elevator Control Installation and Wiring manual for detailed information on wiring the elevator control boards to this access controller and to the elevator push button control panel.

2.1.6 Ferrite Filter

The access controller comes with two (2) **Ferrite Filters**. These will help prevent noise and hum pickup in the phone lines when using a phone line. One is installed around the 16 VAC power wires on the main terminal #19 and #20. The second is installed around all the wires connected to the aux terminal.

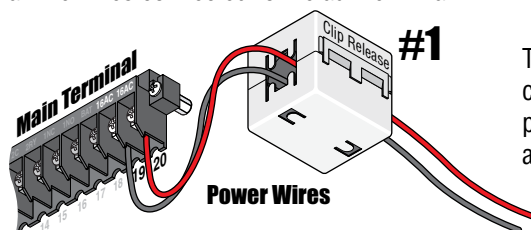

To install the ferrite filter, release the clip on the side to open the filter, place the wires in the circular core and snap the filter closed.

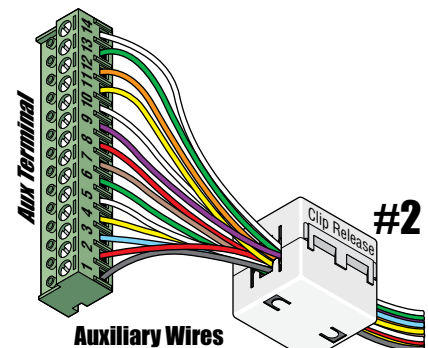

2.2 Terminal Descriptions

See section 4 for the locations of the terminals on the circuit board.

800 ft. max. with 24 AWG wire.
1600 ft. max. with 22 AWG wire.
(Wiring **MUST** be twisted and completely isolated from the ground)

Phone Line Connection (Ring)

Phone Line Connection (Tip)

Earth Ground Only (See Section 2.1.3).

Switch Input. A closure between terminals 4 and 6 will cause the designated relay(s) to activate for the programmed strike time – see 3.2.7. External Postal Switch is connected here, section 1.4.

Microphone Input.

Common for switch input #4, Microphone, Speaker and Standby Battery NEGATIVE.

Speaker Output.

(Not used).

(Not used).

(Not used).

“Z” Button Input. A closure between terminals 11 and 6 will dial the phone number stored under directory code 1, 01, 001 or 0001.

“A” Button Input. A closure between terminals 12 and 6 will dial the phone number stored under directory code 0, 00, 000 or 0000.

Relay 2 Common – 30 Volt, 3 Amp max.

Relay 2 Contact – 30 Volt, 3 Amp max.

Relay 1 Common – 30 Volt, 3 Amp max.

Relay 1 Normally Closed – 30 Volt, 3 Amp max.

Relay 1 Normally Open – 30 Volt, 3 Amp max.

Microphone Power and Standby Battery POSITIVE for Phone System Only (12 VDC, .7 Ah, SLA) (connect negative to terminal 6)

100 ft. max. with 18 AWG wire. 16 VAC Input Power
200 ft. max. with 16 AWG wire. 20 VA min. 16 VAC Input Power

RS-232 Terminal Removable

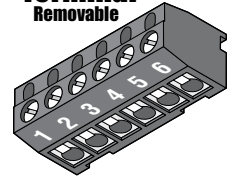

- 1 Transmit Data
- 2 Receive Data
- 3 Request to Send
- 4 Clear to Send
- 5 Signal Ground - Shell
- 6 Not used

Note: Located on the upper right corner of circuit board. The 6-pin terminal can be removed for easy wiring. Connects a PC (See Section 2.5.1).

Relay 0 Terminal Non-Removable



- Normally Open – 30 Volt, 3 Amp max.
- Normally Closed – 30 Volt, 3 Amp max.
- Common – 30 Volt, 3 Amp max.

Aux Terminal Removable

Note: The 14-pin aux terminal can be removed for easy wiring. Expansion boards are connected here when used. See **Expansion Tracker Board Manual** 2358-065 and section 2.3.2, 2.3.3 for more information.

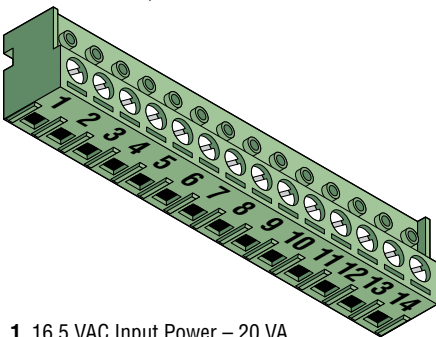

- 1 16.5 VAC Input Power – 20 VA. (Powers RS-232, elevator control and Wiegand)
 - 2 16.5 VAC Input Power – 20 VA.
 - 3 Standby Battery POSITIVE (12 VDC, .7 Ah, SLA).
 - 4 Standby Battery NEGATIVE (For Wiegand Only).
 - 5 16 VAC Output.
 - 6 16 VAC Output.
 - 7 DATA 0.
 - 8 DATA 1.
 - 9 Common.
 - 10 +12 VDC Power.
 - 11 DATA 0.
 - 12 DATA 1.
 - 13 Common.
 - 14 +12 VDC Power.
- For card readers that have additional lighting for outdoor use.
- 26, 30 and 31 Bit Wiegand input (Card Reader) activates **Relay 2** for programmed strike time
- 26, 30 and 31 Bit Wiegand input (Card Reader) activates **Relay 1** for programmed strike time

Main Terminal

Relay 2 Jumper

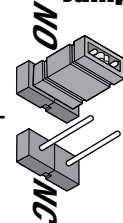

Relay 2 Note: Normally Open and Normally Closed relay jumper is used to set **Relay 2** input on the circuit board (See section 4.3).

Elevator Control Terminal Non-Removable

- 3 COMMON – Connect to terminal 22 of elevator control board.
- 2 DATA 0 – Connect to terminal 21 of elevator control board.
- 1 DATA 1 – Connect to terminal 20 of elevator control board.

Note: Connect to the Elevator Control Board (2348-010). See **Elevator Control Board Manual** 2348-065 for more info.

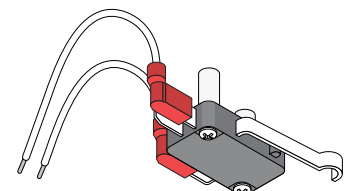

UL 294 Tamper Switch

Note: Located at top of enclosure board (See Section 1.5).

2.3 Access Controller Circuit Board Wiring

2.3.1 - NO Tracker Expansion Boards, Remote Call or Intercom Stations

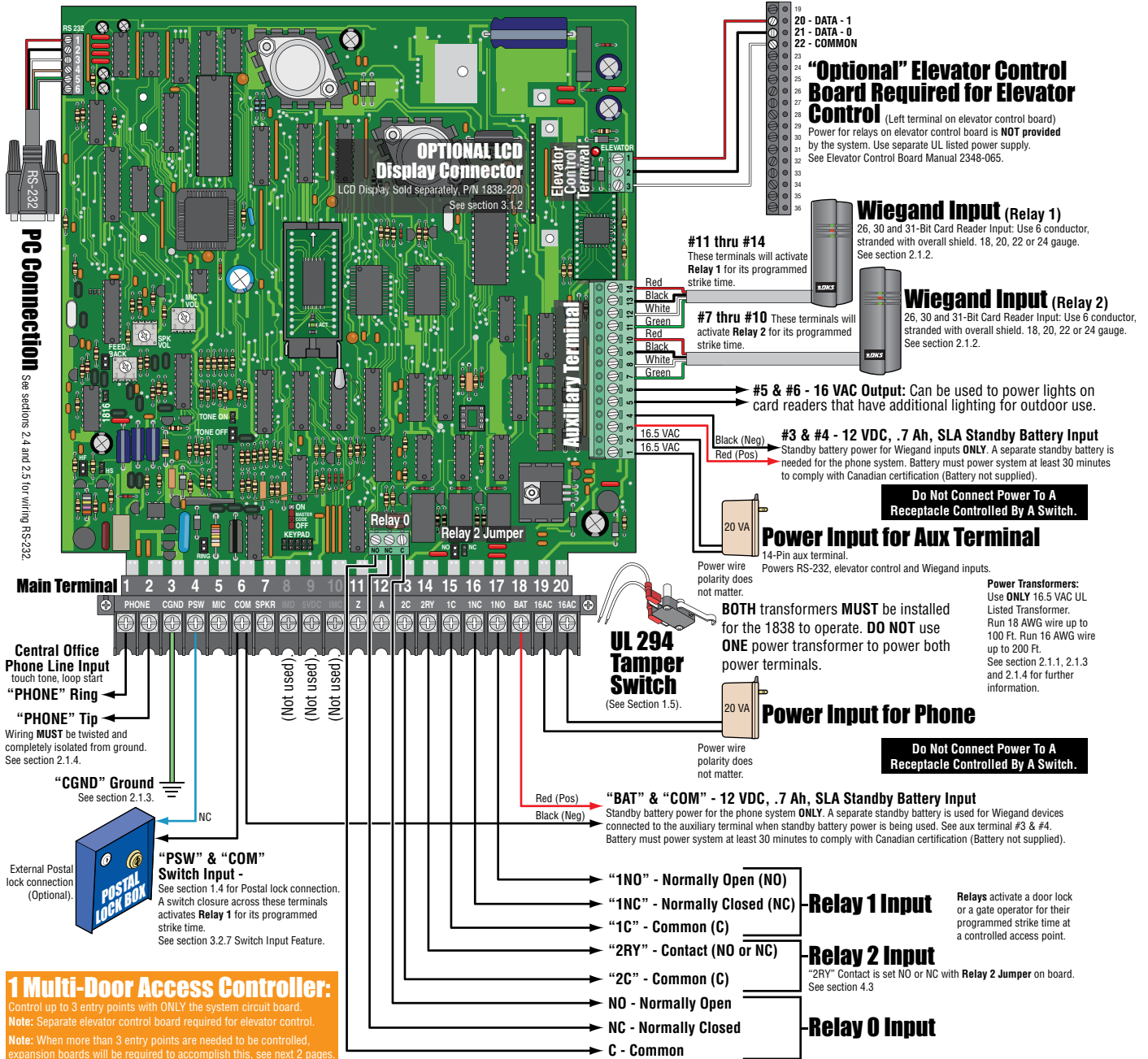

1 Multi-Door Access Controller:

Control up to 3 entry points with ONLY the system circuit board.
Note: Separate elevator control board required for elevator control.
Note: When more than 3 entry points are needed to be controlled, expansion boards will be required to accomplish this, see next 2 pages.

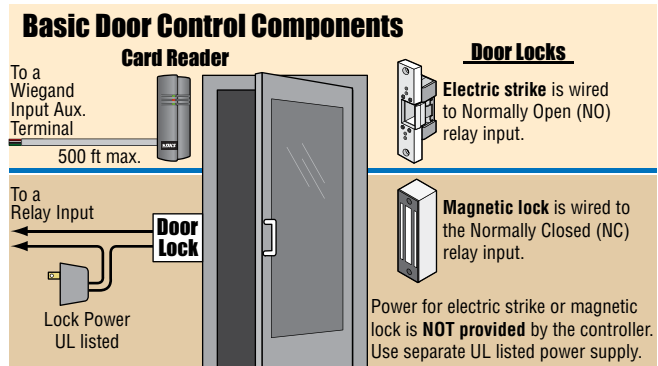
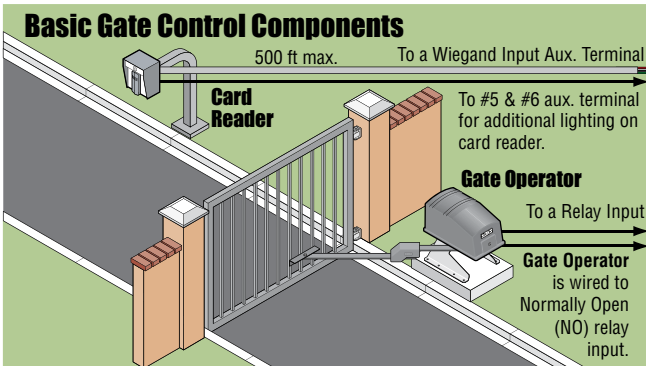

2.3.2 Tracker Expansion Boards (Hardwired)

The model 2358 Tracker Expansion Board (sold separately) allows you to expand the number of remote entry points that the access controller can control. One tracker expansion board is required for **EACH** remote entry point. Up to 48 boards can be hardwired to the circuit board's **Aux Terminal** (First 24 boards connected to #7 - #9 and 24 more boards connected to #11 - #13 if needed). Tracker expansion boards must have their own power source and the farthest board can be no more than 2000 ft from the access controller. Each board must have a board address set on it to identify it to the access controller and if wiring more than 8 boards, some zone addresses need to be used for identification. The tracker expansion boards are pre-programmed with many features but can be re-programmed for specific needs when desired. See **Tracker Expansion Board Manual 2358-065** for **ALL** wiring and programming options.

This access control equipment must be installed inside of a controlled, protected or restricted area. See page 3 for more information.

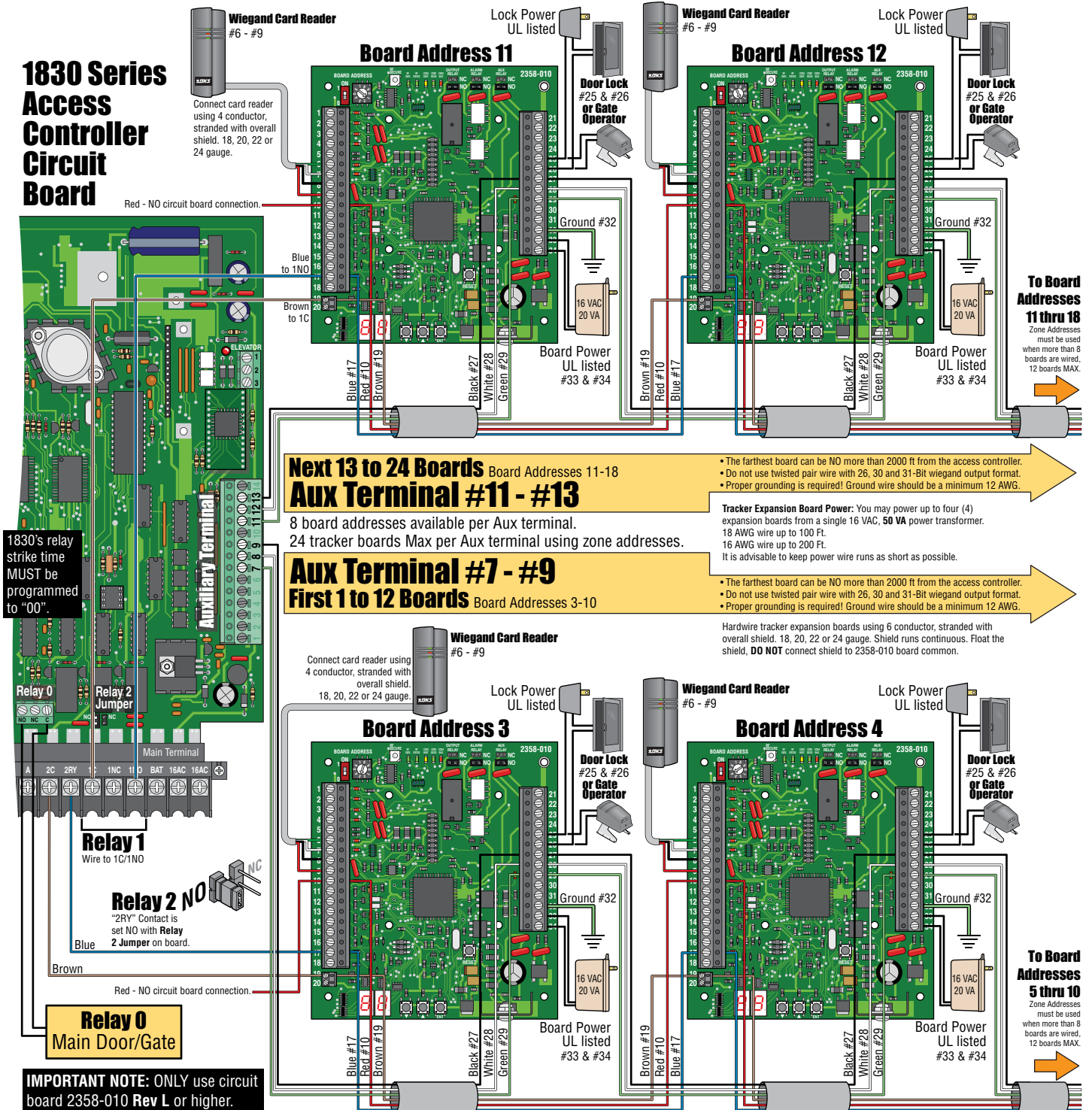

2.3.3 Tracker Expansion Boards using 900 MHz Wireless Communication

The model 2358 Tracker Expansion Board (sold separately) allows you to expand the number of remote entry points that the access controller can control. One tracker expansion board is required for **EACH** remote entry point. Communicate wirelessly between the tracker expansion boards and the 1838 controller without having to run wiring from each remote access point to the 1838 controller. The model 1470 wireless tracker expansion board kit and the model 2333 wireless baseboard kit (each sold separately) plugged onto circuit boards for wireless communication. Wireless tracker expansion boards can be up to 100 ft from the access controller (approximate). This distance can be extended by using longer range antennas (sold separately) and/or a 2332 wireless dual band repeater (sold separately). Each tracker expansion board must have a board address set on it to identify it to the access controller. **Board addresses 3-10 will activate RELAY 2** and **11-18 will activate RELAY 1** on the access controller. Board addresses can be set the same for multiple boards (zone addresses) when **MORE** than 8 boards need to activate a specific RELAY (24 boards MAX for each relay). The tracker expansion boards are pre-programmed with many features but can be programmed for specific needs when desired (See **Tracker Expansion Board Manual 2358-065** for **ALL** programming options). See DoorKing's web site and the instruction sheets with the wireless kits for complete installation information when using wireless communication.

This access control equipment must be installed inside of a controlled, protected or restricted area. See page 3 for more information.

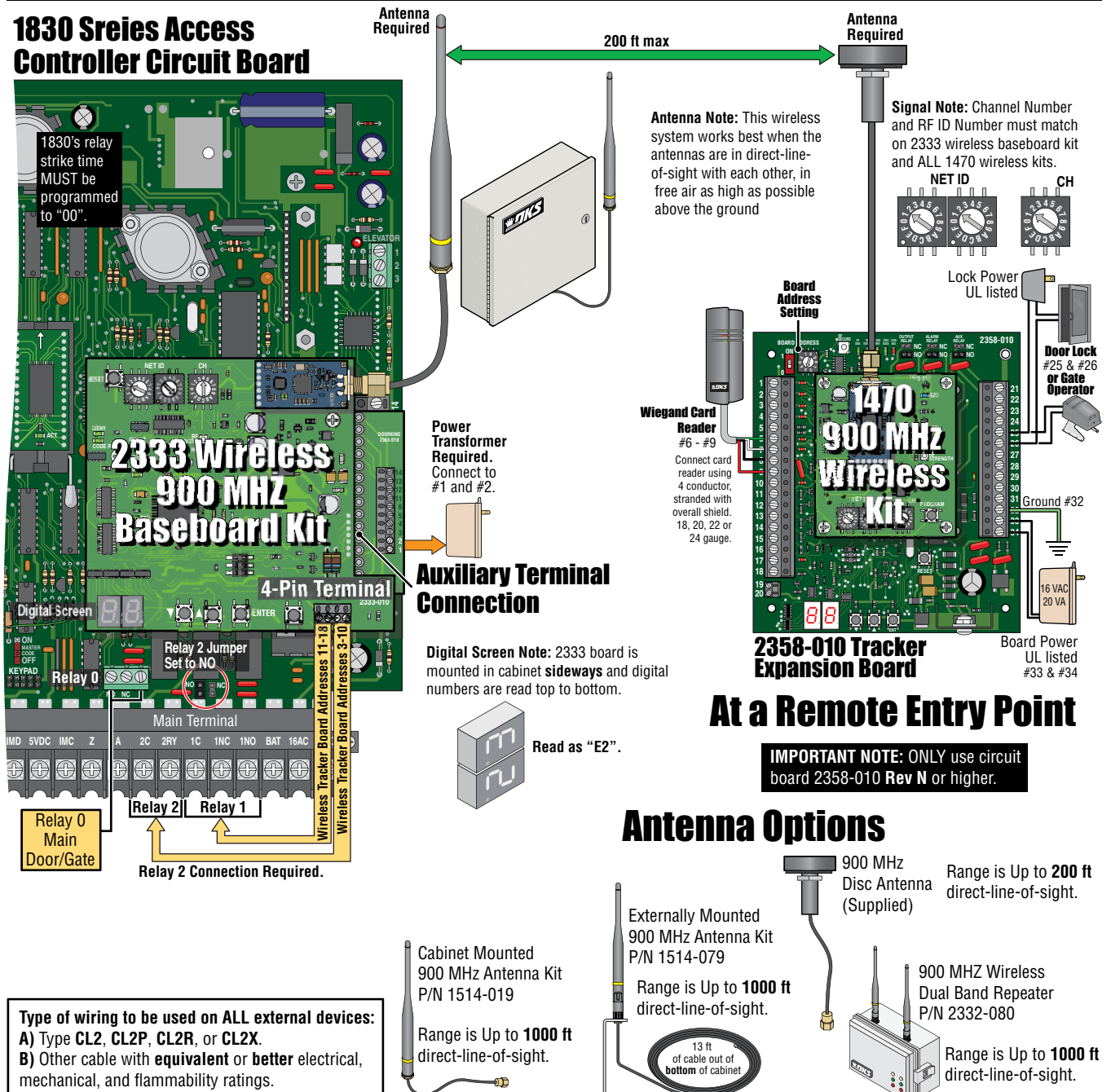

2.3.4 - ONE Remote Call Station

Sold Separately, provides voice communication to a remote location via the telephone network. Wiegand Relay 1 will activate for the programmed strike time.

- Remote Call Station with Keypad. P/N 1838-120.
- Remote Call Station with AWID card reader. P/N 1838-122.
- Remote Call Station with HID card reader. P/N 1838-123.
- Remote Call Station with DK Prox card reader. P/N 1838-124.

100 feet Maximum Between Remote Call Station and the 1838.

1838

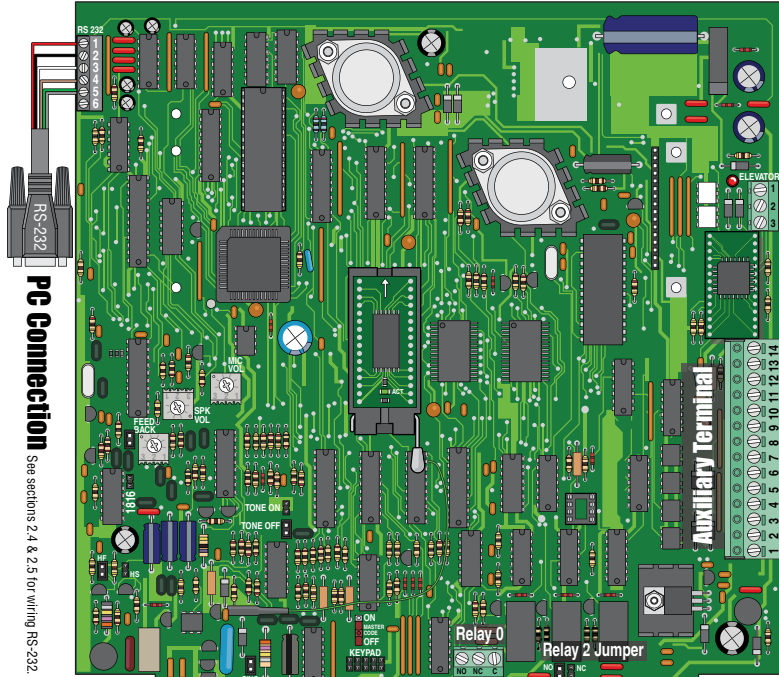

Activates Relay 1

Use 4 conductor, stranded with overall shield, 18, 20, 22 or 24 gauge for wiegand connection.

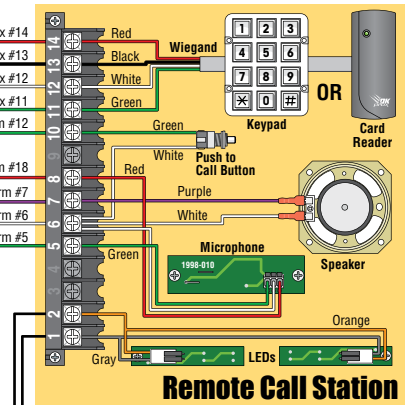

16.5 VAC 20 VA Power Transformer OR connect to Aux term #5 & #6

Use ONLY 16.5 VAC UL Listed Transformer.
Run 18 AWG wire up to 100 Ft.
Run 16 AWG wire up to 200 Ft.



Central Office Phone Line Input
touch tone, loop start
"PHONE" Ring
"PHONE" Tip
Wiring MUST be twisted and completely isolated from ground. See section 2.1.4.

"CGND" Ground
See section 2.1.3.

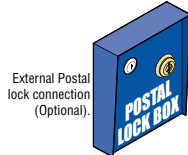

"PSW" & "COM" Switch Input
See section 1.4 for Postal lock connection. A switch closure across these terminals activates Relay 1 for its programmed strike time. See section 3.2.7 Switch Input Feature.

#5 & #6 - 16.5 VAC Output: Can be used to power remote call station. Power wire polarity does not matter.

#3 & #4 - 12 VDC, .7 Ah, SLA Standby Battery Input
Standby battery power for Wiegand inputs ONLY. A separate standby battery is needed for the phone system. Battery must power system at least 30 minutes to comply with Canadian certification (Battery not supplied).

Do Not Connect Power To A Receptacle Controlled By A Switch.
16.5 VAC 20 VA Power for Aux Terminal
14-Pin aux terminal. Powers RS-232, elevator control and Wiegand inputs. Power wire polarity does not matter.

BOTH transformers MUST be installed for the 1838 to operate. DO NOT use ONE power transformer to power both power terminals.

20 VA Power for Phone
20 VA power for phone system ONLY. Do Not Connect Power To A Receptacle Controlled By A Switch.

Red (Pos) "BAT" & "COM" - 12 VDC, .7 Ah, SLA Standby Battery Input
Black (Neg) Standby battery power for the phone system ONLY. A separate standby battery is used for Wiegand devices connected to the auxiliary terminal when standby battery power is being used. See aux terminal #3 & #4. Battery must power system at least 30 minutes to comply with Canadian certification (Battery not supplied).

"1NO" - Normally Open (NO)
"1NC" - Normally Closed (NC)
"1C" - Common (C)
Relay 1 Input

"2RY" - Contact (NO or NC)
"2C" - Common (C)
Relay 2 Input
"2RY" Contact is set NO or NC with Relay 2 Jumper on board. See section 4.3

NO - Normally Open
NC - Normally Closed
C - Common
Relay 0 Input

Relays activate a door lock or a gate operator for their programmed strike time at a controlled access point.

Power for electric strikes or magnetic locks are NOT provided by the 1838. Use a separate UL listed power supply.

2.3.6 - Intercom Station

Sold Separately, provides voice communication to a remote location via an intercom system. Wiegand Relay 1 will activate for the programmed strike time.

Intercom Station with Keypad. P/N 1504-120.

Intercom Station with AWID card reader. P/N 1504-122.

Intercom Station with HID card reader. P/N 1504-123.

Intercom Station with DK Prox card reader. P/N 1504-124.

MAX distance between Intercom Station and 1838:

- 650 ft with 22 AWG
- 1000 ft with 20 AWG
- 1600 ft with 18 AWG

1838

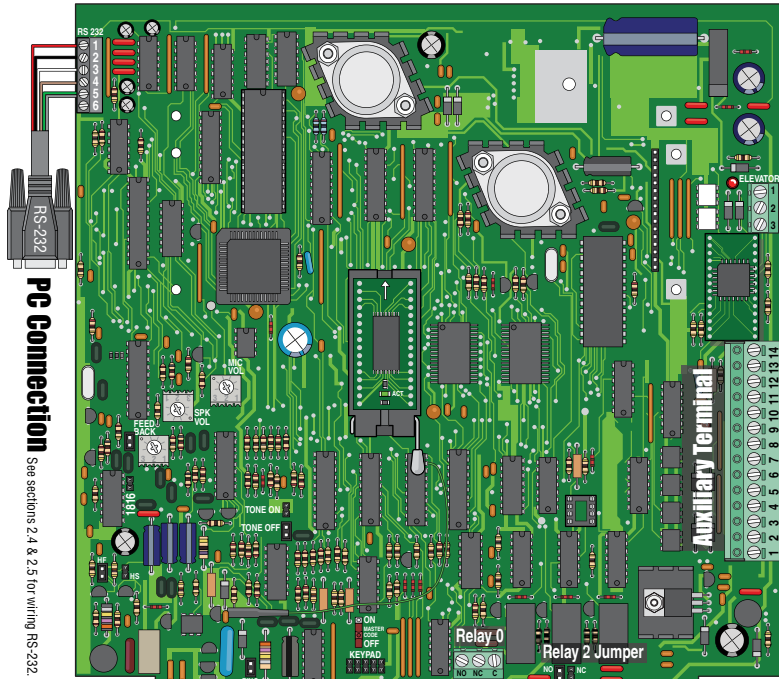

Activates Relay 1

Use 4 conductor stranded with overall shield for wiegand connection.

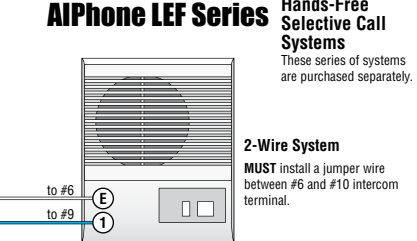
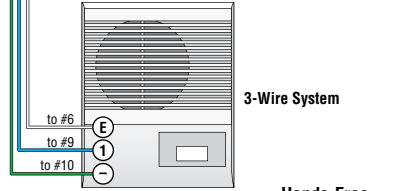
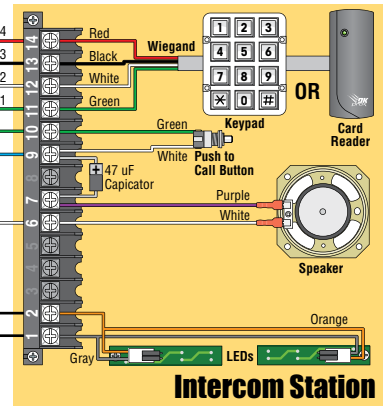

#5 & #6 - 16.5 VAC Output: Used to power intercom station. Power wire polarity does not matter.

#3 & #4 - 12 VDC, .7 Ah, SLA Standby Battery Input
Standby battery power for Wiegand inputs **ONLY**. A separate standby battery is needed for the phone system. Battery must power system at least 30 minutes to comply with Canadian certification (Battery not supplied).

Do Not Connect Power To A Receptacle Controlled By A Switch.

Power for Aux Terminal
14-Pin aux terminal.
Powers RS-232, elevator control and Wiegand inputs.

Power wire polarity does not matter.
BOTH transformers **MUST** be installed for the 1838 to operate. **DO NOT** use **ONE** power transformer to power both power terminals.

Power for Phone
20 VA power for phone system **ONLY**.

Do Not Connect Power To A Receptacle Controlled By A Switch.

"BAT" & "COM" - 12 VDC, .7 Ah, SLA Standby Battery Input
Standby battery power for the phone system **ONLY**. A separate standby battery is used for Wiegand devices connected to the auxiliary terminal when standby battery power is being used. See aux terminal #3 & #4. Battery must power system at least 30 minutes to comply with Canadian certification (Battery not supplied).

Relay 1 Input
"1NO" - Normally Open (NO)
"1NC" - Normally Closed (NC)
"1C" - Common (C)

Relays activate a door lock or a gate operator for their programmed strike time at a controlled access point.

Relay 2 Input
"2RY" - Contact (NO or NC)
"2C" - Common (C)
*2RY" Contact is set NO or NC with Relay 2 Jumper on board. See section 4.3

Relay 0 Input
NO - Normally Open
NC - Normally Closed
C - Common

Power for electric strikes or magnetic locks are **NOT** provided by the 1838. Use a separate UL listed power supply.

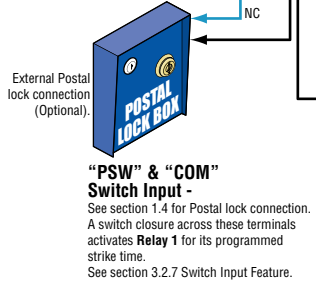
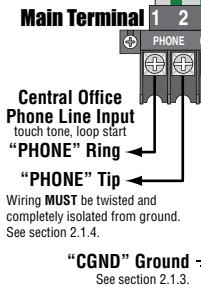

2.4 PC (Data) and Phone (Voice) Connection Options

There are **THREE ways** to connect to the 1838 for data transfer (programming) and Optional voice **ONLY** if using a DoorKing Call Station. The method that you choose is dependent on the type of connection available at the 1838.

1 **No wired connection available** – use DKS cellular service.

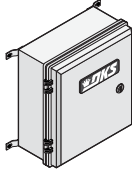

DoorKing Cellular Service (see 2.4.1):
Use P/N 1800-080 for Data Connection and Optional Voice Connection for a DoorKing Call Station **ONLY**.

DKS Software setting: DKS Cellular

2 **Network cable available** – use **DKS Data over the Internet** or use **third party providers** of your own choosing.



DoorKing VoIP/RS-232 Control Box (see 2.4.2a):
Use P/N 2334-080. DKS VoIP Connection (Voice - using a DoorKing Call Station) **AND** RS-232 for Data Connection.

DKS Software setting: DKS VoIP Voice + Data



DoorKing Data over IP Service (see 2.4.2b):
Use P/N 1830-186 for Data Connection.
ONLY use P/N 1815-568 for DKS VoIP Connection (Voice) if using a DoorKing Call Station.

DKS Software setting for Data ONLY:
DKS Data over IP

DKS Software setting for Data and Voice:
DKS VoIP Voice + Data

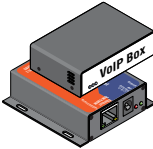

Third Party Service (see 2.4.2c):
Use P/N 1830-185 for Data Connection.
ONLY use **Third Party VoIP** Connection (Voice) if using a DoorKing Call Station.

DKS Software setting: Network

3 **Telephone line available** – use **DKS IM Server Modem** or use **your own modem**.

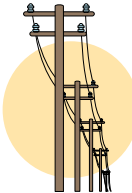

DKS IM Server Modem Service (see 2.4.3a):
Use **IM Server Modem** for Data Connection.
Optional Voice is used for a DoorKing Call Station **ONLY**.

DKS Software setting: IM Server Modem

Third Party Service (see 2.4.3b):
User supplied modem for Data Connection.
Optional Voice is used for a DoorKing Call Station **ONLY**.

DKS Software setting: Modem to Modem

2.4.1 DoorKing Cellular Network Connection - Data Transfer/Optional Voice

Requires VOICE/DATA Cellular System kit (P/N 1800-080). Manage 2 (two) 1838s through DoorKing's cellular network server where cellular service is available.

DoorKing Cellular service is available for one low monthly fee without any long term contracts. Cellular service is provided by AT&T 4G LTE where available.



VOICE/DATA
Cellular System Kit
P/N 1800-080

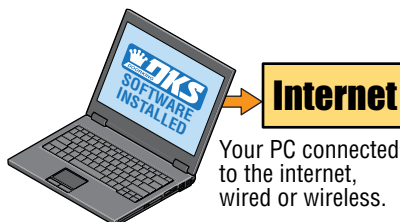

DKS Cellular Server
hosted by AT&T cellular network
with DKS Online
Registration Completed

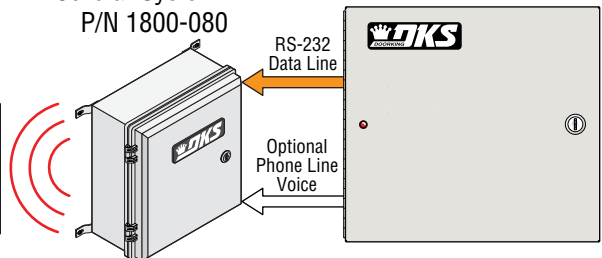

Voice Note: ONLY connect a phone line when using a DoorKing Call Station.

See instruction sheet that comes with VOICE/DATA cellular system kit for further information on wiring and online registration.

2.4.2a DoorKing VoIP/RS-232 Control Box - Data Transfer/Optional Voice

Requires DKS VoIP/RS-232 Control Box P/N 2334-080. Works with DoorKing's Data over IP through the internet.

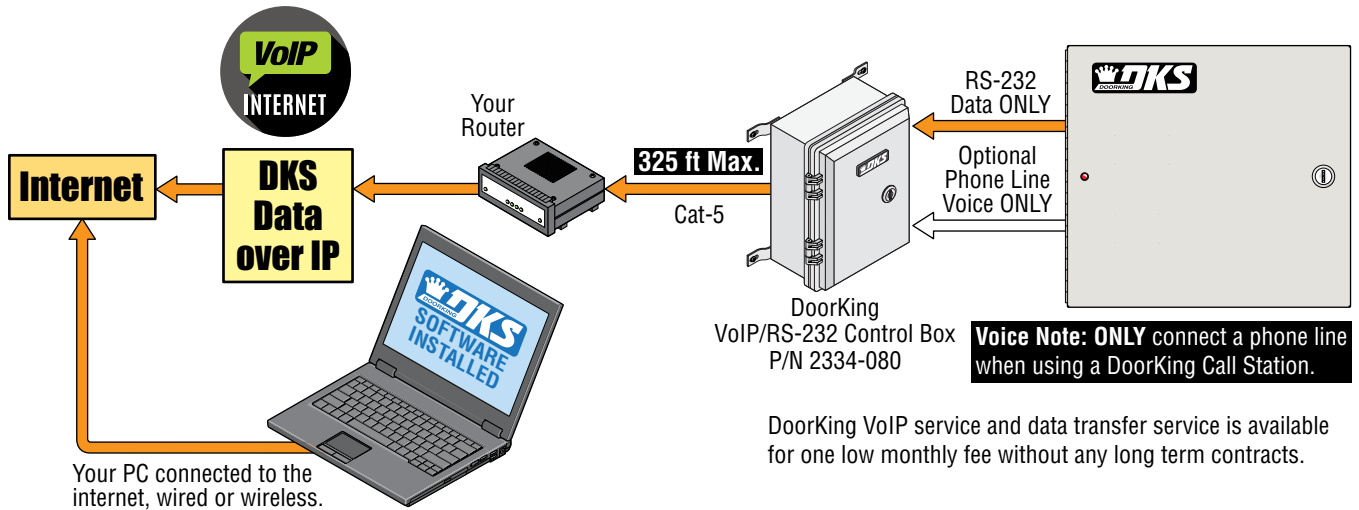

2.4.2b DoorKing VoIP Internet Connection - Data Transfer/Optional Voice

Requires a DKS TCP/IP Converter Kit P/N 1830-186 and VoIP Adapter Kit P/N 1815-568. Works with DoorKing's Data over IP through the internet.

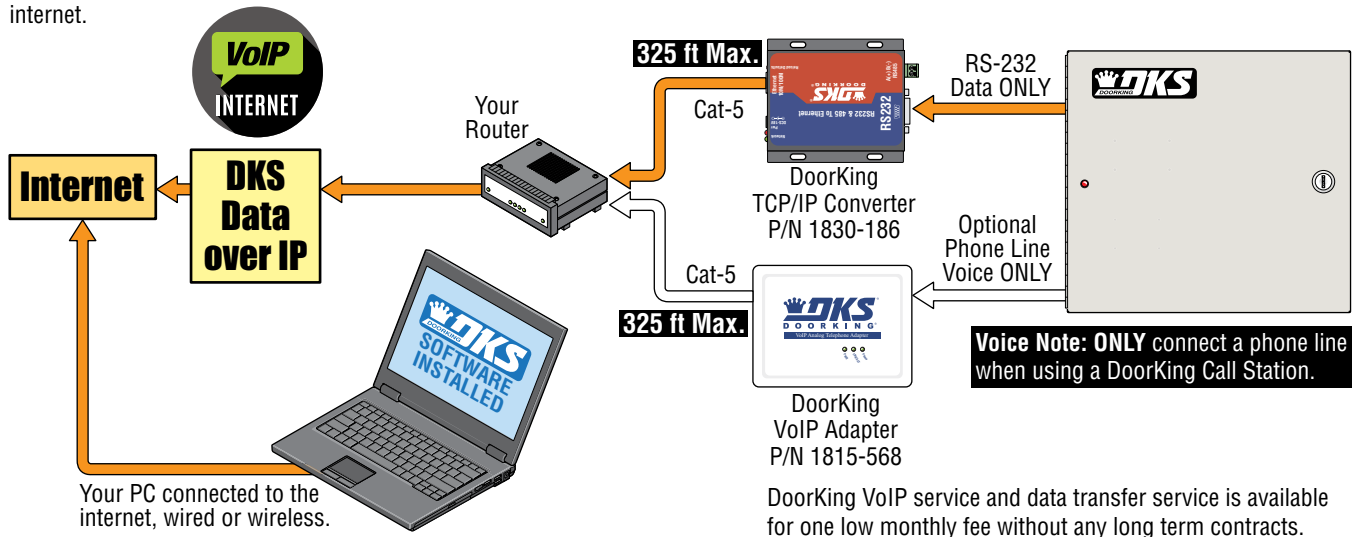

2.4.2c Third Party VoIP Internet Connection - Data Transfer/Optional Voice

Requires a DKS TCP/IP Converter Kit (Third Party) P/N 1830-185 and Your VoIP Adapter (most VoIP adapters will work).

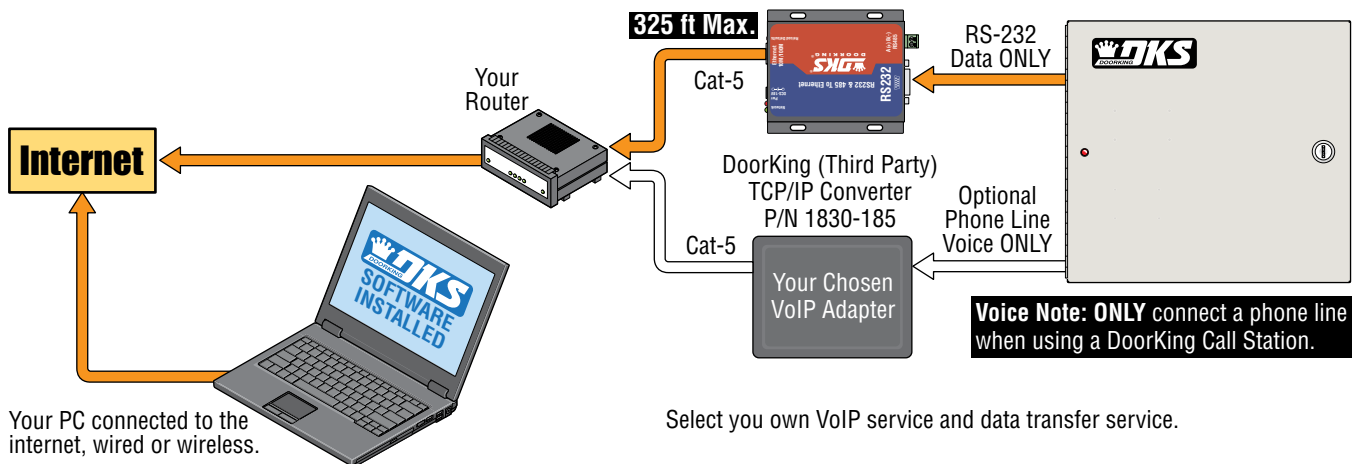

2.4.3a DoorKing IM Server Modem Connection - Data Transfer/Optional Voice

NO additional hardware required. Works with DoorKing's IM Server modem over the internet.

DoorKing IM Server modem service is available for one low monthly fee without any long term contracts.

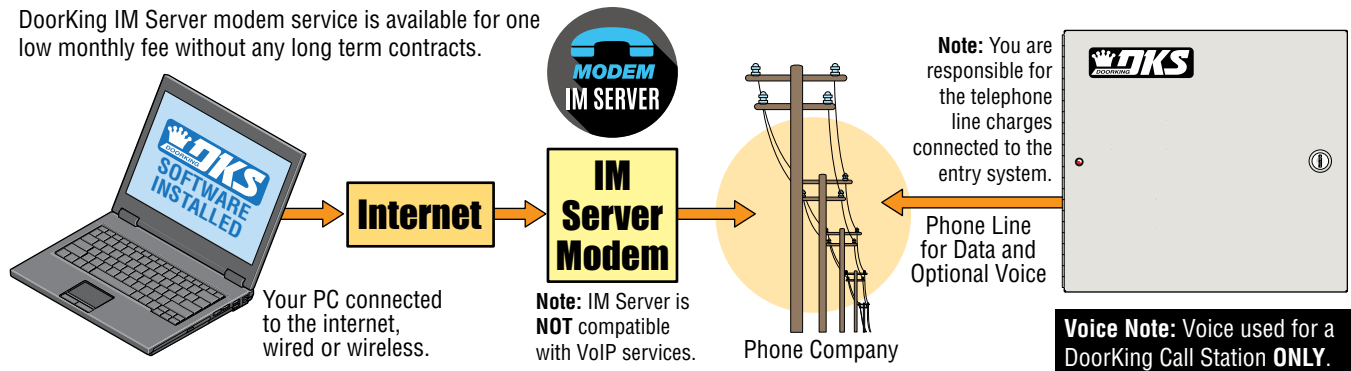

2.4.3b Dial-Up Phone Modem Connection - Data Transfer/Optional Voice

Use your EXISTING phone modem to connect your PC to the 1838.

Note: Telephone companies will **NOT** support this phone line connection to a access controller system after 2020.

DoorKing does NOT guarantee modem connections.

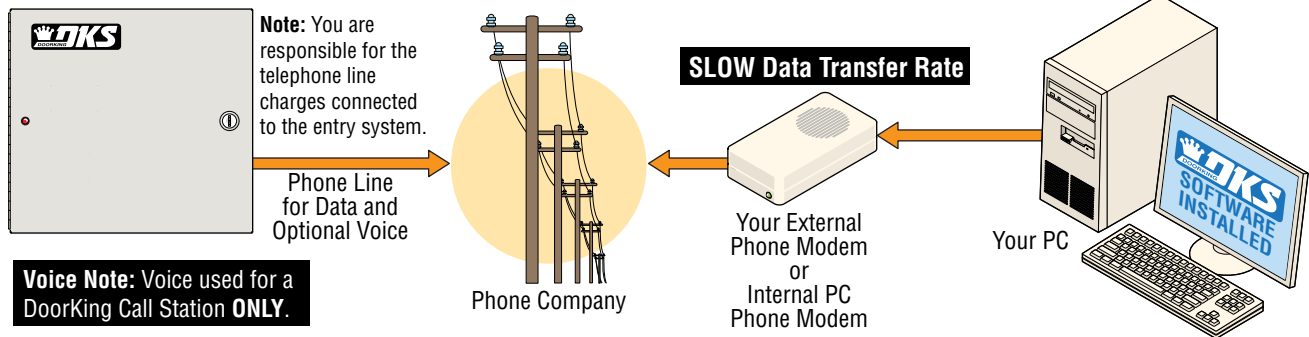

Note: In some cases, digital phone service (VoIP for example) may negatively affect modem service.

2.5 Direct Connection to PC Options - Data Transfer ONLY

2.5.1 RS-232 Direct Connection to PC - Data Transfer ONLY

Requires DoorKing RS-232 9-pin cable P/N 1818-040 and RS-232 to USB Adapter P/N 1815-037 to connect to a PC.

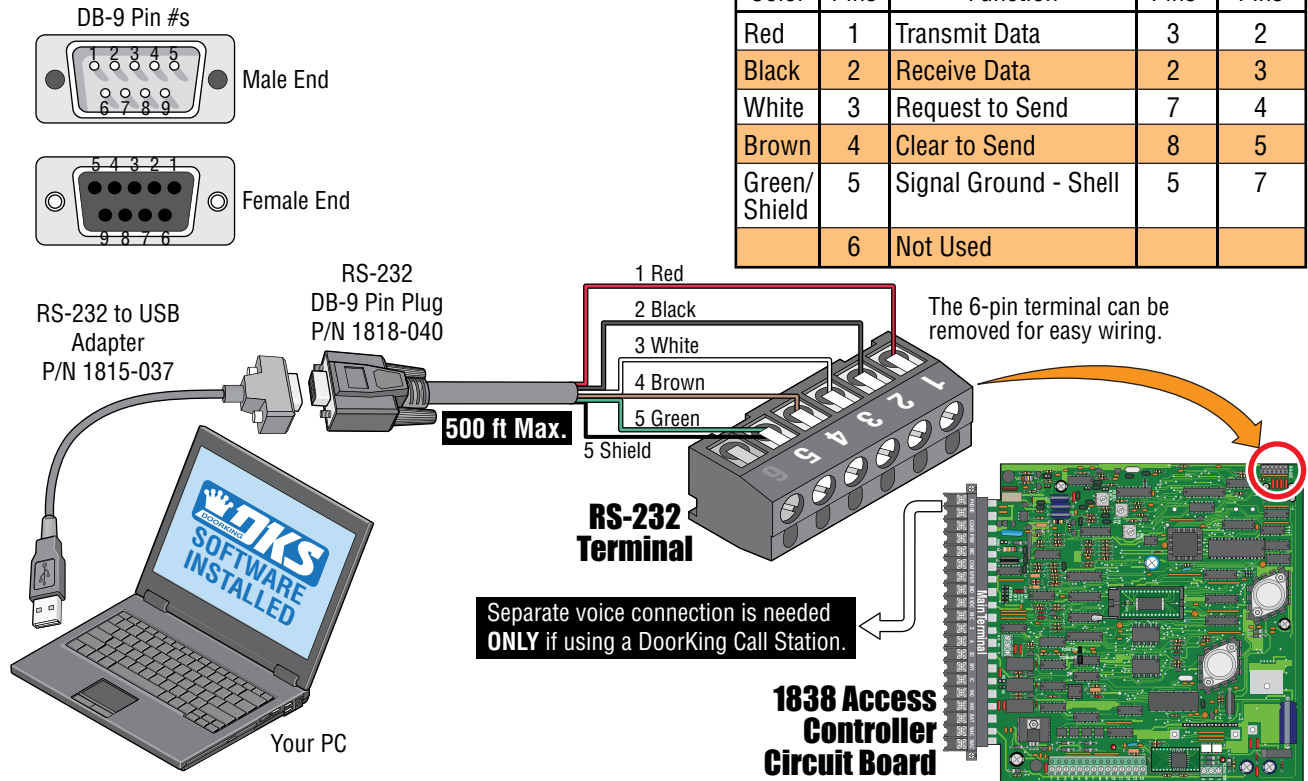

2.5.2 RS-422/USB Direct Connection to PC - Data Transfer ONLY

Requires RS-422 adapter kit (P/N 1508-055).

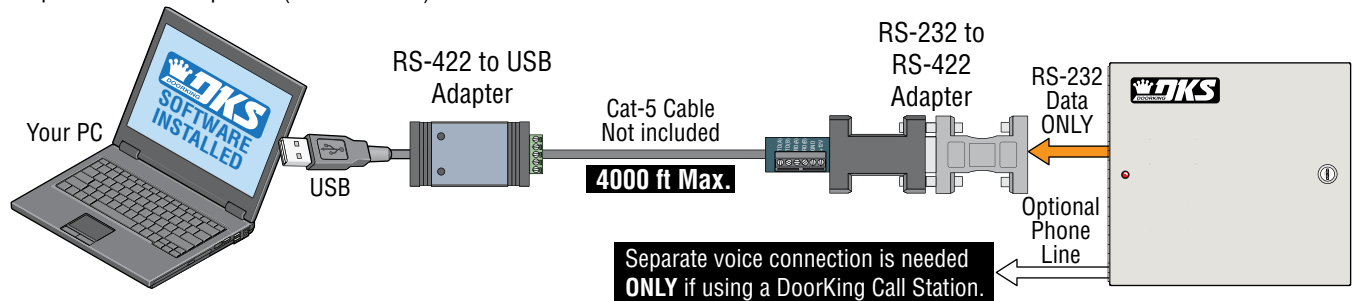

2.5.3 TCP/IP Converter Direct Connection to PC - Data Transfer ONLY

Requires TCP/IP Converter Kit (P/N 1830-185).

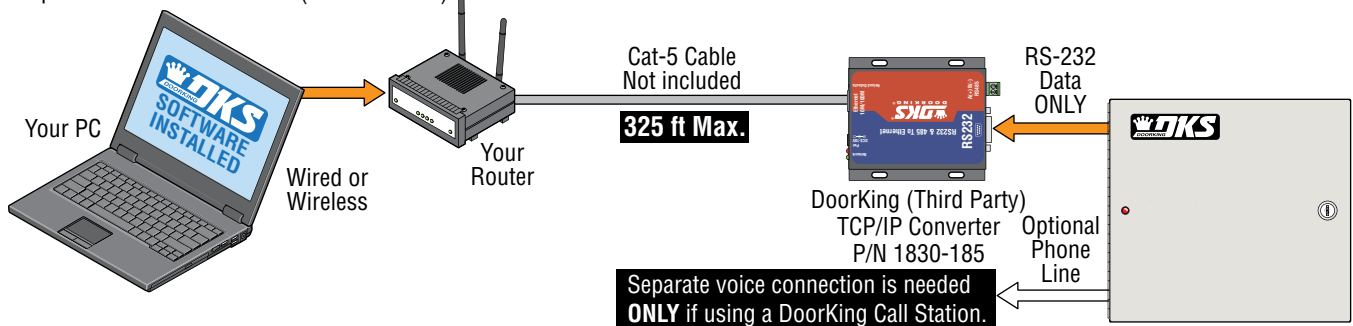

SECTION 3 - PROGRAMMING

We strongly suggest that you read these programming instructions in their entirety before beginning any programming of this access controller.

IMPORTANT! Many of the advanced features available with this 1838 access controller **CANNOT** be programmed from the system keypad. These advanced features include relay hold open time zones, security levels, elevator control options and programming via the internet using DKS servers. If any of these advanced features are used, the 1838 **MUST** be programmed with a PC using the **DoorKing Remote Account Manager for Windows** software, VERSION 6.4.i or higher. Refer to the software help screen for more information on these advanced features.

3.1 General Programming Information

The DoorKing PC Programmable 1838 access controller is primarily programmed by using the DoorKing Remote Account Manager for Windows software. However, the access controller can also be partially programmed from the keypad inside the enclosure.

Programming the 1838 access controller can also be performed off-site using a user supplied PC with the DKS software loaded on it. Make sure the **RING pin jumper** is in place on the circuit board, which was factory installed. See section 4.2 for more information.

The PC programmable 1838 access controller has three relays on the circuit board, all of which are programmable for any function required. These relays are designated as Relay 0 (R 0), Relay 1 (R 1), and Relay 2 (R 2). If Expansion boards are used with this 1838, it is very important that you understand the function of these three relays. The wiegand input auxiliary terminals (also the Expansion board input terminals) can only cause R 1 or R 2 to activate. Wiegand input devices **CANNOT** cause R 0 to activate. Therefore, if Tracker Expansion boards are used with this system, **R 0 MUST be designated as the PRIMARY relay**, and R 1 and R 2 are then designated as Tracker Expansion board command (CMD) relays with R 2 controlling Expansion boards 1 through 8 (system relays 3-10), and R 1 controlling Expansion boards 9 through 16 (system relays 11-18). The **PRIMARY** relay is the relay that a resident activates from their telephone after receiving a call from a visitor. When Tracker Expansion boards or other wiegand devices are used with the 1838, be sure that R 0 is programmed to respond to the tone open number (typically 9), the postal switch input, and the rotary dial 9 function.

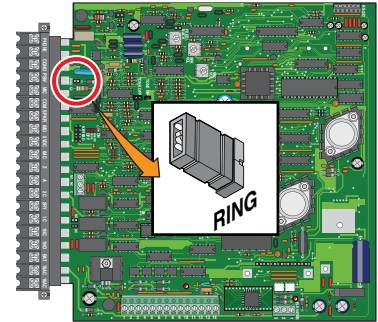

3.1.1 Programming from a PC

Prior to programming the 1838 with a PC and the DoorKing Remote Account Manager for Windows Software, there is certain information that you must know and must program into the 1838 before the computer can communicate with it. See section 3.2 to set-up the 1838 for PC programming. Programming the 1838 with a PC may be accomplished by different connections. See sections 2.4 and 2.5 PC Connection Options for all layouts and **additional hardware** that is needed for each. **All options require the DoorKing Remote Account Manager for Windows Software VERSION 6.4.i or higher.**

3.1.2 Programming from the 1838 Access Controller Keypad

Follow the programming instructions as described in each section of this manual. The 1838 will prompt you with short tones (**beep**) when programming steps have been followed correctly, and with a long tone (**beeeeeep**) when the programming step is ended. The **OPTIONAL** LCD display screen (sold separately, P/N 1838-220) can also assist you in viewing the information that you are programming. It is highly recommended that you complete the resident information in section 7 in back of this manual prior to programming from the 1838 keypad. This will provide you with the information needed to complete the manual programming sequence (section 3.2). When programming from the 1838 keypad, after each programming step is performed correctly, a short tone (**beep**) will be heard. When the programming session is ended, a long tone (**beeeeeep**) will be heard.

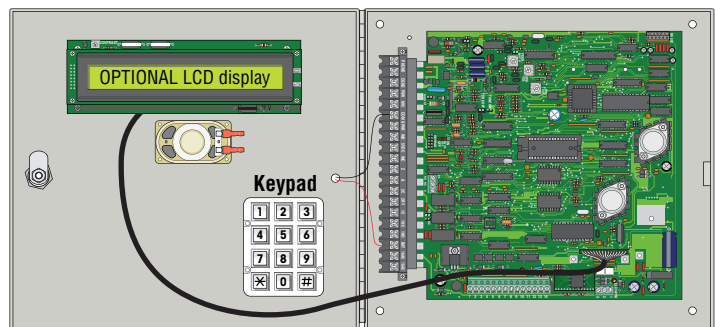

Inside 1838 Enclosure

Important Note: Relay hold open time zones, security levels, holiday schedules, anti-pass back IN / OUT tables, anti-pass back re-sync schedules and elevator control features **CANNOT** be programmed from the 1838 keypad. **These advanced features can only be programmed from a connected PC using the DoorKing Remote Account Manager Software.**

3.2 Set-up 1838 Access Controller for PC Programming

Prior to using a PC to program this PC Programmable 1838 access controller with the DoorKing Remote Account Manager for Windows software, section 3.2 factory settings **MUST** be reviewed or re-programmed if necessary (most factory settings are typically desired). There is no need to re-program these settings unless you want to change them. For easy reference, refer to the chart on page 29 that list the various programming functions and their factory default settings. **Section 3.2 can ONLY be programmed from the 1838 Keypad. There is NO programming sequence in the Remote Account Manager Software to program these features with.**

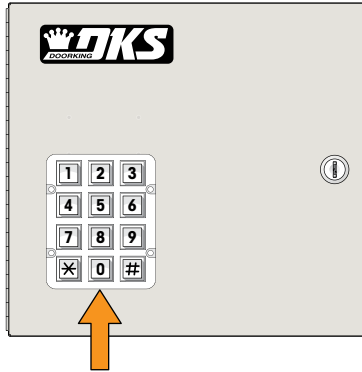

1838 keypad is located **INSIDE** enclosure.

Important Note: If you make a mistake while programming, press **0** **#** keys at the same time to escape from programming no matter how much has been completed, then begin again at step 1.

3.2.1 Master Code

This programming step sets the 1838 **MASTER CODE**. The master code is the four-digit number **REQUIRED** to gain access to the 1838 memory. **You need to know the master code prior to programming the 1838 with the PC, or to perform ANY of the programming functions on the following pages. It MUST be programmed in from the 1838 keypad.**

NO Factory setting - Each 1838 access controller's master code **MUST** be unique. See section 4.1 for more information about the master code switch.

1. Open the enclosure of the 1838 and turn the master code switch **ON**.
2. Enter a four-digit master code **?? ??** then press ***** (beep).
3. Turn the master code switch **OFF** and close the enclosure.

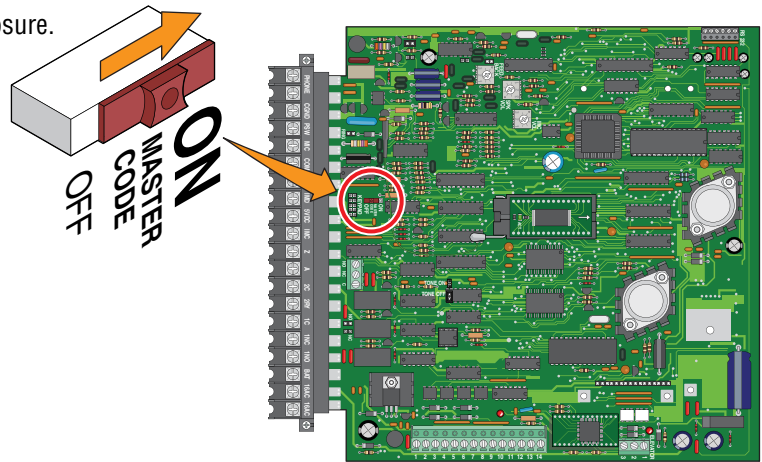

Important Note: There is no way of retrieving the master code after it has been programmed in. If you forget it, you will have to program in a new one but all other previously programmed information will remain intact.

3.2.4 Resident Elevator Button Relay Time

When elevator control is in use, an access device such as a card reader must be installed in the elevator car to allow residents access to the floors in the building. The time interval that the button(s) is “live” after the resident activates the access device is dependant on the revision level of the 1830 series circuit board, not the 2348 elevator control board. **The relay time interval for 1830 series circuit boards with revision level A-E is set at 7 seconds. The time interval can be programmed from 1 – 254 seconds on boards with revision level F and higher.**

Factory setting = 007 (7 seconds)

1. Press **[*][3][6]** and enter your four-digit MASTER CODE **[?][?][?][?]** (beep).
The **OPTIONAL** LCD display will read: RES ELE TIME xxx SEC
2. Enter the **relay time** in seconds using **three-digits** (001 – 254), then press **[*]** (beep).
3. Press **[0][#]** together to end this programming step (**beeeeeep**).

3.2.5 “Tone Open” Sound On or Off

The following programming sequence turns the “**Tone Open**” sound On or Off (when the relays activate). This feature is available on Rev K boards or higher. See 3.3.3 for information about “Tone Open” numbers feature.

Factory setting = 1 (tone ON)

1. Press **[*][1][5]** and enter your four-digit MASTER CODE **[?][?][?][?]** (beep).
The **OPTIONAL** LCD display will read: BEEP RLY OP? 0=N 1=Y
2. Enter **[1]** for **YES - tone will sound** or **[0]** for **NO - tone will not sound**, then press **[*]** (beep).
3. Press **[0][#]** together to end this programming sequence (**beeeeeep**).

3.2.6 RS-232 Speed Setting

The following programming sequence sets an optional slower RS-232 speed. This feature is available on Rev M boards or higher and the Remote Account Manager Software, Version 6.4.i, must be used.

Factory setting = 1 (19200 baud rate)

1. Press **[*][8][5]** and enter your four-digit MASTER CODE **[?][?][?][?]** (beep).
2. Enter **[0]** for **9600 baud rate** or **[1]** for **19200 baud rate**, then press **[*]** (beep).
3. Press **[0][#]** together to end this programming sequence (**beeeeeep**).

3.2.7 Switch Input Feature

The following programming sequence sets the switch input (main terminals #4 and #6) to either activate a relay(s) or call the phone number programmed in directory code 0, 00, 000 or 0000. Refer to section 3.3.4 to determine which relay(s) will activate when the switch input is activated. This feature is available on Rev K boards or higher.

Factory setting = 0 (switch input activates relay)

1. Press **[*][1][8]** and enter your four-digit MASTER CODE **[?][?][?][?]** (beep).
The **OPTIONAL** LCD display will read: KEY IN DIAL? 0=N 1=Y
2. Enter **[1]** for **YES** (the switch input will dial a phone number) or **[0]** for **NO** (the switch input will activate the relay), then press **[*]** (beep).
3. Press **[0][#]** together to end this programming sequence (**beeeeeep**).

3.2.8 Elevator Control Feature

This new elevator feature authorizes floor access to the Floor Level identified in the Resident Screen **in the software program AND** to the floor(s) level identified in the Security Level screen. If this feature is turned off, access will be granted only the floor identified in the user's security level. This feature is available on Rev K boards or higher.

Factory setting = 1 (new elevator function is turned ON)

1. Press **✖ 7 5** and enter your four-digit MASTER CODE **?? ??** (beep).
The **OPTIONAL** LCD display will read: NEW EL FUNC? 0=N 1=Y
2. Enter **1** for **YES** (access is authorized to both the floor identified in the resident screen and to the floor(s) identified in the user's security level) OR **0** for **NO** (access is authorized only to the floor(s) identified in the security level screen), then press **✖** (beep).
3. Press **0 #** together to end this programming sequence (beeeeeep).

3.2.9 Single or Multiple 1838s using ONE Phone Line

This program sequence sets the 1838 to operate as a single unit on **ONE** phone line, or to share the phone line with other units. If multiple units are sharing the same phone line, then each one must be set as a "multiple system" and each must have a unique master code.

Factory setting = Single System.

1. Press **✖ 0 4** and enter your four-digit MASTER CODE **?? ??** (beep).
2. Press **0 ✖** (beep) for a **single system**, OR **1 ✖** (beep) for **multiple systems**.
3. Press **0 #** together to end this programming sequence (beeeeeep).

3.2.10 DKS Data over IP Phone Number or System ID Number

The following programming sequence is necessary **ONLY** when using **DoorKing DKS Data over IP**. After installing the Remote Account Manager Software, Version 6.4.i, there is an option to use the DoorKing **DKS Data over IP** service type on the System Information screen. **When registering an entry system online with the DKS Data over IP requires either the 10-digit phone number of the entry system or 10 digit ID number which DKS Data over IP will assign when registering.** This phone number or ID number **MUST** be programmed into the entry system to use the **DKS Data over IP**.

Visit <http://www.doorking.com> for more information.

Factory setting = No number in system

1. Press **✖ 5 9** and enter your four-digit MASTER CODE **?? ??** (beep).
2. Enter the **10-digit phone number** or **ID number - assigned during registration**, then press **✖** (beep).
3. Press **0 #** TOGETHER to end this programming sequence (beeeeeep).

Notes: This programming sequence **automatically** turns **DKS Data over IP** ON (section 6.1.9).
To view programmed number in system see section 6.1.7. To check for problems see section 6.1.8.

3.2.11 Re-Program Memory Size, with/without Cards and Anti-Pass Back

These features **ONLY** need to be **re-programmed** when a **NEW 1838** access controller is to be used with **EXISTING OLDER 1830** telephone entry systems that have a **smaller memory size (less than 3000) with or without cards and anti-pass back capability** and all units are being managed by DKS Remote Account Manager Software with the “Share Info” feature. **The new 1838 chip specification MUST MATCH** the older 1830 chip specifications or **EXISTING** programming conflicts will occur.

Factory setting = Step 2 - 8 (3000), Step 4 - 2 (Using Cards WITH Anti-Pass Back)

1. Press and enter your four-digit MASTER CODE (beep).

The **OPTIONAL** LCD display will read: MEM SIZE? 1 THRU 8

CAUTION: This programming sequence will **erase ALL** information stored on the existing memory chip.

2. Enter a **single-digit** for memory size (1-8), then press (beep).

1=25 2=75 3=125 4=250 5=500 6=1000 7=2000 8=3000

The **OPTIONAL** LCD display will read: xxxx MEM OK? 0=N 1=Y (xxxx is the memory you have chosen).

3. Press **YES** (beep), OR **NO** (beep).

Note: Selecting NO (0*) will go back to the previous step.

After **YES** (1*) is entered, The **OPTIONAL** LCD display will read: CARDS 0=N 1=Y 2=ANTI

4. Press (beep) **NO Cards**, OR (beep) **Use Cards**, OR (beep) **Use Cards with Anti-Pass Back**

The **OPTIONAL** LCD display will read: ERASE MEM? 1=Y 0=N

5. Press **YES** (beep), OR **NO** (beep).

Note: Selecting NO (0*) will go back to the first step.

After **YES** (1* BEEP) is entered, A long beep will be heard after memory has been erased (**beeeeeep**).

3.2.12 Turn LIVE Transaction Viewing On or Off

The following programming sequence turns the “**LIVE**” Transaction viewing on your PC **On** or **Off**.

When turned **ON**, all transactions can be viewed “Real-Time” from your PC.

When turned **OFF**, the transaction buffer must be downloaded before viewing the transaction history log. The transaction buffer stores the last **8000 events** when downloaded.

Factory setting = 0 (OFF)

1. Press and enter your four-digit MASTER CODE (beep).

The **OPTIONAL** LCD display will read: view live? 0=NO 1=YES

2. Enter for **YES - view live transactions** or for **NO - don't view live transactions**, then press (beep).

3. Press together to end this programming sequence (**beeeeeep**).

STOP!!

If the 1838 is to be programmed from a PC, **NO** other programming is required at the 1838 itself. Refer to the Remote Account Manager for Windows Software help screens for additional programming information. Continue with the remaining sections in this chapter if the 1838 will be programmed by any other method. If the factory setting matches your need, there is no reason to reprogram that section.

Remember that advanced features like relay hold open time zones, security levels, and elevator control functions can **ONLY** be programmed from the Remote Account Manager Software. If any of these advanced features are being used, **DO NOT** proceed with any other programming steps in this manual.



Download **REMOTE ACCOUNT MANAGER** Software **FREE** at:
<http://www.doorking.com/telephone/software>

Overview for 1838 Keypad Programming

	Page #	Section	Command	Factory Setting
NOT Programmable from Software. Program from 1838 Keypad ONLY.	Section 3.2 Setup 1838 for PC Programming			
			Master Switch ON	No factory setting
	25	3.2.1		
	26	3.2.4	* 36	007 (7 sec)
	26	3.2.5	* 15	1 (tone ON)
	26	3.2.6	* 85	1 (19200 Baud)
	26	3.2.7	* 18	0 (activates relay)
	27	3.2.8	* 75	1 (Turned ON)
	27	3.2.9	* 04	Single 1838
	27	3.2.10	* 59	Issued by DoorKing
28	3.2.11	* 95	8-3000 Memory 2-Card w/Anti-Pass Back	
28	3.2.12	* 19	OFF	
Testing DKS Data over IP	47	6.1.7	* 56	Testing Option
	47	6.1.8	* 29	Testing Option
	47	6.1.9	* 55	Testing Option OFF
Section 3.3 General Programming using 1838 Keypad				Relay 0: 01 (1 sec) Relay 1: 01 (1 sec) Relay 2: 01 (1 sec)
30	3.3.1	* 03		
30	3.3.2	* 08		060 (60 sec)
31	3.3.3	* 05		Relay 0: # # # # Relay 1: 9 8 7 6 Relay 2: 5 4 3 2
31	3.3.4	* 50		010 (relay 1 activates)
32	3.3.5	* 07		Touch-tone
32	3.3.6	* 51		010 (relay 1 activates)
Section 3.4 Not Applicable to 1838				
Section 3.5 Programming Phone Numbers				
33	3.5.1	* 20		Three (3) digits
33	3.5.2	* 01		No factory setting
34	3.5.3	* 24		No factory setting
34	3.5.4	* 41		No factory setting
35	3.5.6	* 01		No factory setting
35	3.5.8	* 24		No factory setting
35	3.5.10	* 09		No factory setting
35	3.5.11	* 27		1 (Pause ON)
Section 3.6 Programming 5-Digit PIN Device Codes				
36	3.6.1	* 70		No factory setting
36	3.6.2	* 71		No factory setting
36	3.6.3	* 72		No factory setting
36	3.6.4	* 73		No factory setting
Section 3.7 Programming Four-Digit Entry Codes				
37	3.7.1	* 02		No factory setting
37	3.7.2	* 02		No factory setting
37	3.7.3	* 12		No factory setting
Section 3.8 Anti-Pass Back				
38	3.8.1	* 43		No factory setting
38	3.8.2	* 45		No factory setting
38	3.8.3	* 46		No factory setting
38	3.8.4	* 48		No factory setting

Note: Program section numbers have been intentionally skipped that **DO NOT** apply to the specific access controller in this manual. This allows **ALL** of the 1830 series manuals (1834-065 rev H or higher and 1835-065) to remain in sync with each other when referencing programming numbers.

3.3 General Programming Using the 1838 Keypad

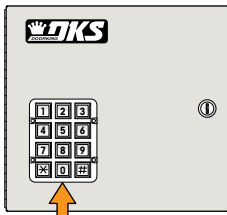

1838 keypad is located
INSIDE enclosure.

Proceed with the programming steps on the following pages **ONLY IF** PC programming **WILL NOT** be used. The 1838 keypad may be used to program some features on the access controller but can be a little tedious to use. We strongly suggest that you become familiar with the programming steps in each feature you want to use **BEFORE** actually programming the 1838.

Important Note: If you make a mistake while programming, press **0 #** keys at the same time to escape from programming no matter how much has been completed, then begin again at step 1.

3.3.1 Relay Strike Time

These steps will program Relay 0, Relay 1 and Relay 2 strike times. Strike times can be programmed from 1/4 second up to 99 seconds by entering the desired time in seconds as a two-digit number in step 3. If Expansion boards are going to be used with this 1838, set Relay 2 strike time to 00 for Expansion boards 1-8. If more than 8 Expansion boards are being used, set Relay 1 strike time to 00 (for Expansion boards 9-16) and then set Relay 0 strike time for the desired time in seconds. In this application, Relay 0 becomes the **PRIMARY** relay that will open the door or gate after the resident presses **9** on their telephone.

Factory setting for relay strike times are: Relay 0 = 01 (1 sec), Relay 1 = 01 (1 sec), Relay 2 = 01 (1 sec).

1. Press *** 0 3** and enter your four-digit MASTER CODE **? ? ? ?** (beep).
2. Press **0 *** (beep) to set **Relay 0**, OR **1 *** (beep) to set **Relay 1**, OR **2 *** (beep) to set **Relay 2** strike time.
3. Enter the **two-digit strike time** in seconds (00-99), then press ***** (beep).
(Example: 1/4 second - enter 00, 1 second - enter 01 etc.)
4. Repeat steps 2 and 3 to set other relay strike times.
5. Press **0 #** together to end this programming sequence (**beeeeeep**).

Tracker Expansion Board Note: The relay strike time **MUST** be set to “00” when using a tracker expansion board or it will **NOT** function.

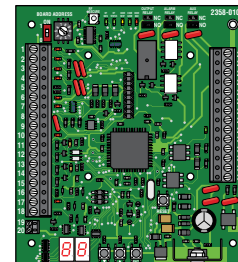

Tracker Expansion Board

3.3.2 Talk Time

This programming is **only used** when a DKS Remote Call Station is connected to the 1838. It sets the maximum time allowed for conversation when the 1838 places a call to a phone number programmed under directory code 2, 02, 002 or 0002 (inputs **A-Z** together). The talk time can be set from 1 second up to 255 seconds (4 minutes, 15 seconds) and is entered as a three-digit number in step 2. The talk time set here **DOES NOT** affect the telephone numbers that are programmed under directory codes 0, 00, 000, 0000 (Input **A**) and 1, 01, 001, 0001 (Input **Z**). The talk time for these two directory code sets are **factory set to the maximum**. Phone numbers programmed under these directory codes should be **reserved for management or emergency phone numbers** that generally require longer conversations.

Factory setting for talk time = 060 (60 seconds).

1. Press *** 0 8** and enter your four-digit MASTER CODE **? ? ? ?** (beep).
2. Enter the **three-digit talk time** in seconds (001-255), then press ***** (beep).
(Example: 1 second - enter 001, 20 seconds - enter 020 etc.)
3. Press **0 #** together to end this programming sequence (**beeeeeep**).

3.3.3 Tone Open Numbers

Program the 4 different tone open functions (see chart below) for Relays 0, 1 and 2. Each number of a four-digit number code controls each of the 4 functions. **If the function is not desired, enter # instead of a number.** If Expansion boards are connected to the 1838, there is no need to set a momentary activation tone open number for the Expansion control relay(s). However, you may want to program **HOLD** and **RELEASE** tone open numbers, that can allow **ONLY management** to have a way to automatically unlock **ALL** doors/gates controlled by **ALL** the Expansion boards at once during an emergency (see section 5.2.2).

Factory setting:

Relay 0 = (# # # #) #-no momentary, #-no hold, #-no release, #-no hold 1 hour

Relay 1 = (9 8 7 6) 9-momentary, **8**-hold, **7**-release, **6**-hold 1 hour

Relay 2 = (5 4 3 2) 5-momentary, **4**-hold, **3**-release, **2**-hold 1 hour.

1. Press and enter your four-digit MASTER CODE (beep).
2. Press (beep) to set **Relay 0**, OR (beep) to set **Relay 1**, OR (beep) to set **Relay 2** tone numbers.
3. Enter a **four-digit tone open number code**, then press (beep).

Example: If you want a relay to have a momentary activation function **only** when the number **9** is pressed, enter **9 # # #**.
 If a function is not desired, enter # instead of a number in that digit position. **DO NOT duplicate** any 4 digits.
 Example: DO NOT program relay 0 tone open number code to 9999, 0 relay will NOT function.

1st Digit
2nd Digit
3rd Digit
4th Digit

4-Digit Tone Open Number Code	Relay Function After Digit has been Pressed on Phone
1st Digit	Momentary activation. Relay will activate for the programmed strike time (3.3.1).
2nd Digit	Hold. Relay will activate and remain activated until commanded to release.
3rd Digit	Release. Deactivates the relay hold command.
4th Digit	Hold 1-hour. Relay will activate for 1-hour and then will automatically deactivate itself.

4. Repeat steps 2 and 3 to set other relay tone open numbers.
5. Press together to end this programming sequence (beeeeeep).

3.3.4 Switch Input Relay(s) Activation

This programming sequence sets which relay(s) will activate when the **switch input** (main terminals #4 and #6) is activated on the 1838. It can be programmed so that only one relay will activate, or any combination of relays will activate in step 2.

TIP: The relay that you designate as the **primary relay** should be programmed to activate from the **postal switch input**.

Factory setting = 010 (“0”relay 0-will **NOT** activate)(“1”relay 1-**WILL** activate)(“0”relay 2-will **NOT** activate)

1. Press and enter your four-digit MASTER CODE (beep).
2. Enter the **three-digit** (1's or 0's only) **relays activation code**, then press (beep).

Three-digit positions: 1st digit position - **Relay 0**, 2nd digit position - **Relay 1**, 3rd digit position - **Relay 2**.

To activate a relay - enter a **1** in a digit position.

To **NOT** activate a relay - enter a **0** in a digit position.

Example: entering 010 will cause only relay 1 to activate. Entering 101 will cause both relay 0 and relay 2 to activate.

3. Press together to end this programming sequence (beeeeeep).

3.3.5 Touch-Tone / Rotary-Dial

This programming is **only used** when a DKS Remote Call Station is connected to the 1838. It will set the 1838 to dial out in either a **touch-tone** or **rotary** format. Generally, this will be set for touch-tone.

Factory setting = touch-tone.

1. Press and enter your four-digit MASTER CODE (beep).
2. Press (beep) for **touch-tone**, OR (beep) for **Rotary**
3. Press together to end this programming sequence (beeeeeep).

3.3.6 Rotary-Dial 9 Relay(s) Activation

This programming sequence sets which relay(s) will activate when the 1838 receives a **rotary-dial 9 open command** from a residents rotary telephone. The 1838 can be programmed so that only one relay will activate, or any combination of relays will activate. TIP: The relay that you designate as the **Primary** relay should be programmed to activate when a rotary **9** command is dialed from a resident telephone.

Factory setting = 010 (only relay 1 activates)

1. Press **✖** **5** **1** and enter your four-digit MASTER CODE **?** **?** **?** **?** (beep).
2. Enter the **three-digit** (1's or 0's only) **rotary 9 code**, then press **✖** (beep).

Three-digit positions: 1st digit position - **Relay 0**, 2nd digit position - **Relay 1**, 3rd digit position - **Relay 2**.

To activate a relay - enter a 1 in a digit position.

To **NOT** activate a relay - enter a 0 in a digit position.

Example: entering 010 will cause only relay 1 to activate. Entering 101 will cause both relay 0 and relay 2 to activate.

3. Press **0** **#** together to end this programming sequence (beeeeeep).

3.5 Programming Phone Numbers

These programming steps are **ONLY** used when a DKS 1838-120 or 1838-121 Remote Call Station is connected to the 1838.

3.5.1 Programming the Directory Code Length

This programming sequence sets the directory code length to 1 - 2 - 3 or 4 digits.

Factory setting is three (3) digits.

CAUTION: This programming sequence will delete **ALL** phone numbers and directory codes that have been **previously** programmed into the system.

1. Press **[*][2][0]** and enter your four-digit MASTER CODE **[?][?][?][?]** (beep).

The **OPTIONAL** LCD display will read: # OF DIRECTORY CODE DIGITS

2. Enter 1, 2, 3 or 4 digits, then press **[*]** (beep).

The **OPTIONAL** LCD display will read: ERASE MEM? 1=Y 0=N

3. Entering **[0][*]** will cancel out of this program if desired (beeeeeep).

Entering **[1][*]** will change the directory code length (and erase **ALL** existing memory).

The **OPTIONAL** LCD display will read: ERASING

A long beep will sound when complete (beeeeeep).

Directory code digit length has now been programmed.

3.5.2 Programming Directory Codes with 7-Digit Phone Numbers - NO Area Code

In this programming sequence, the directory codes **AND** 7-digit phone numbers will be programmed into the system. Be sure you have programmed the directory code length that you desire as described in 3.5.1 above. **Changing the directory code length after programming the telephone numbers will ERASE all the numbers and directory codes that have been programmed.** To program phone numbers that will need to use an area code (long distance calls and 10-digit calling), program them in 3.5.4. Only three (3) directory codes are available; 0, 1, 2 (also 00, 000, 0000; 01, 001, 0001; 02, 002, 0002) depending on the directory code length that was set in 3.5.1. Factory default directory code length is 3 (000, 001, 002).

Note: If the 1838 is being used in **an area that requires 10-digit phone number dialing**, proceed to 3.5.3 and 3.5.4 to program the area code, phone number and directory code.

1. Press **[*][0][1]** and enter your four-digit MASTER CODE **[?][?][?][?]** (beep).

2. Choose and enter a **directory code** (0, 00, 000, 0000 OR 1, 01, 001, 0001 OR 2, 02, 002, 0002), then

press **[*]** (beep). (You cannot duplicate directory codes)

The **OPTIONAL** LCD display will read: PHONE#

3. Enter the **seven-digit phone number**, then press **[*]** (beep).

Note: If the number that you are entering in this step is less than seven-digits, enter # in the empty spaces after the digits have been entered.

For example, if the system is connected to a PBX that requires four-digit extension numbers and you want to enter extension 2217, you would enter this number as 2217###, then press * (beep).

4. Press **[0][#]** together to end this programming sequence (beeeeeep).

3.5.3 Programming Area Codes

Program area codes when 10-digit or long distance calling is required.

The actual area codes will be entered as a four-digit number (1 + the three digit area code). If area codes are being programmed to facilitate 10-digit ("1" not required) calling requirements, precede the three-digit area code with #.

1. Press **[*][2][4]** and enter your four-digit MASTER CODE **[?][?][?][?]** (beep).

"Up to 255" programmed, **OPTIONAL** LCD display will read: 000 – 254 AAC POINTERv

2. Enter a **three-digit area code pointer** (000 – 254), then press **[*]** (beep).

3. Enter the **four-digit area code**, then press **[*]** (beep).

For long distance calling requirements, enter 1 and the three-digit area code (1 + the three digit area code).

For 10-digit calling requirements, enter # and the three-digit area code (# + the three digit area code).

4. Repeat steps 2 and 3 to enter additional area codes. Remember to use a different area code pointer number for every additional area code entered. See the reference tables in back of this manual to assist you further.

5. Press **[0][#]** together to end this programming sequence (beeeeeep).

3.5.4 Programming Phone Numbers that need Area Codes

In this section, phone numbers that are referenced to an area code pointer (long distance and 10-digit dialing calls) will be programmed with the directory code. Be sure that the area code(s) have been programmed as described in the preceding section 3.5.3.

Note: If long distance or 10-digit dialing is **NOT** required, program the seven-digit telephone numbers in section 3.5.2.

1. Press **[*][4][1]** and enter your four-digit MASTER CODE **[?][?][?][?]** (beep).

The **OPTIONAL** LCD display will read: DIRECTORY CODE

2. Choose and enter a **directory code** (1, 2, 3 or 4 digits depending on what was programmed in 3.5.1), then press **[*]** (beep). (You cannot duplicate directory codes)

The **OPTIONAL** LCD display will read: AAC POINTER

3. Enter a **three-digit area code pointer** (000 – 254), then press **[*]** (beep).

The **OPTIONAL** LCD display will read: PHONE #

4. Enter the **seven-digit phone number**, then press (beep).

Note: If the number that you are entering in this step is less than seven-digits, enter # in the empty spaces after the digits have been entered.

For example, if the system is connected to a PBX **[*]** requires a four-digit extension numbers and you want to enter extension 2217, you would enter this number as 2217###, then press * (beep).

5. Repeat steps 2, 3, and 4 to enter additional long distance phone numbers.

6. Press **[0][#]** together to end this programming sequence (beeeeeep).

3.5.6 Deleting Individual Phone Numbers

This programming sequence is used to delete a single phone number under a **known directory code**.

1. Press ***01** and enter your four-digit MASTER CODE **????** (beep).
2. Enter the existing **directory code** (section 3.5.2 or 3.5.4) that the phone number has been assigned to (1, 2, 3 or 4 digits, section 3.5.1), then press ***** (beep).
3. Press **#####** then press ***** (beep).
4. Repeat steps 2 and 3 to delete additional phone numbers.
5. Press **0#** together to end this programming sequence (beeeeeep).

3.5.8 Delete Area Codes

This program sequence deletes area code numbers that have been programmed into the 1838. Refer to section 3.5.4. for programming on step 2.

1. Press ***24** and enter your four-digit MASTER CODE **????** (beep).
“Up to 255” programmed, **OPTIONAL** LCD display will read: 000 – 254 AAC POINTER
2. Enter the **three-digit area code pointer** (000 – 254), then press ***** (beep).
The **OPTIONAL** LCD display will read: 4 DIGIT AREA CODE
3. Enter **####**, then press ***** (beep).
4. Repeat steps 2 or 2A and 3 to delete additional area codes.
5. Press **0#** together to end this programming sequence (beeeeeep).

3.5.10 PBX Line Access Code Programming

If the 1838 is connected to a **PBX telephone system** rather than a dedicated C.O. line, you may need to set the unit to dial a line access code prior to dialing the resident phone number. Typically, the line access code is “9”, but check with the PBX system administrator to be sure.

1. Press ***09** and enter your four-digit MASTER CODE **????** (beep).
2. Enter the single-digit **line access code number**, then press ***** (beep).
3. Press **0#** together to end this programming sequence (beeeeeep).

Note: To change a line access number, enter the correct number in step 2. To delete a line access number, enter # in step 2.

3.5.11 Touch-Tone Dialing Pause

During touch-tone dialing, the 1838 (by default) places a 2 second pause after dialing a line access code (9 in a PBX system for example) and after the area code. For example: 9 (2 second pause) 1310 (2 second pause) 6450023

The 2 second pause can be removed by programming 0 into the steps below. In this example, the 1838 would simply dial out the line access code (9), area code (1310) and phone number (6450023) without any pauses. 913106450023

Factory setting is 1 (pause ON).

1. Press ***27** and enter your four-digit MASTER CODE **????** (beep).
2. Enter **0*** (beep) to turn the pause **OFF**, or enter **1*** (beep) to turn the pause **ON**.
5. Press **0#** together to end this programming sequence (beeeeeep).

3.6 Programming 5-Digit PIN Device Codes

PIN (personal identification number) device codes **MUST** be **five (5) digits in length** and are typically used for a remote Wiegand card reader or transmitter devices. Each device code that you enter must be assigned to a directory code that you select (that was programmed in section 3.5.2). Up to 25 device codes can be entered under a single directory code, up to a maximum of 8,000 total device codes for the 1838. The maximum number that can be programmed in is 65405. **You cannot duplicate device codes.**

3.6.1 Programming Five-Digit Device Codes

This program sequence enters device (card, transmitter, digital) codes into the system memory.

1. Press **[*][7][0]** and enter your four-digit MASTER CODE **[?][?][?][?]** (beep).
2. Enter the existing **directory code** (section 3.5.2 or 3.5.4) that the device code will be assigned to (1, 2, 3 or 4 digits, section 3.5.1), then press **[*]** (beep).
3. Choose and enter a **five-digit device code**, then press **[*]** (beep). (Maximum number that can be programmed in is 65405)
4. Repeat steps 2 and 3 to enter additional device codes. (You cannot duplicate device codes)
5. Press **[0][#]** together to end this programming sequence (beeeeeep).

3.6.2 Deleting Device Codes

This program sequence deletes individual device codes.

1. Press **[*][7][1]** and enter your four-digit MASTER CODE **[?][?][?][?]** (beep).
2. Enter the existing **directory code** (section 3.5.2 or 3.5.4) that the desired device code has been assigned to (1, 2, 3 or 4 digits, section 3.5.1), then press **[*]** (beep).
3. Enter the **desired five-digit device code to be deleted**, then press **[*]** (beep).
4. Repeat steps 2 and 3 to delete additional desired device codes.
5. Press **[0][#]** together to end this programming sequence (beeeeeep).

3.6.3 Enabling Facility Codes

This program sequence allows you to use (**enable**) or not use (**disable**) facility codes.

1. Press **[*][7][2]** and enter your four-digit MASTER CODE **[?][?][?][?]** (beep).
2. Enter **[0][*]** (beep) to **disable** facility codes, or enter **[1][*]** (beep) to **enable** facility codes
3. Press **[0][#]** together to end this programming sequence (beeeeeep).

3.6.4 Programming Facility Codes

This program sequence enters device facility codes into the 1838 memory. Up to 10 facility codes (reference number 0 through 9) may be programmed. Valid facility codes are 000 – 255.

1. Press **[*][7][3]** and enter your four-digit MASTER CODE **[?][?][?][?]** (beep).
2. Enter the **single-digit first facility code reference number** (0 – 9), then press **[*]** (beep).
3. Enter the **three-digit facility code**, then press **[*]** (beep).
4. Repeat steps 2 and 3 to enter additional facility codes.
5. Press **[0][#]** together to end this programming sequence (beeeeeep).

3.7 Programming Four-Digit Entry Codes

A DoorKing remote keypad (P/N 1814-075) is required if four-digit entry codes are going to be used to access a door or gate. **DO NOT** confuse a **FOUR-digit ENTRY code** with a **FIVE-digit PIN (Personal Identification Number) device code** that is entered on a remote wiegand keypad (see previous page). Four-digit entry codes can **ONLY** activate relays 0, 1 or 2 on the 1838 circuit board. They will **NOT** work on wiegand devices connected to tracker expansion boards. If tracker expansion boards are controlled by relay 2, the four-digit entry codes must **ONLY** be set to activate relay 0 or 1. If relays 1 and 2 are used to control tracker expansion boards, then four-digit entry codes must **ONLY** be set to activate relay 0. Each entry code that you enter must be assigned to a directory code that you select (that was programmed in section 3.5.2). Only **ONE** entry code can be programmed for each directory code. **You cannot duplicate entry codes.**

3.7.1 Programming Four-Digit Entry Codes

1. Press **✖** **0** **2** and enter your four-digit MASTER CODE **?** **?** **?** **?** (beep).
2. Enter the existing **directory code** (section 3.5.2 or 3.5.4) that the entry code will be assigned to (1, 2, 3 or 4 digits, section 3.5.1), then press **✖** (beep).
3. Choose and enter a **four-digit entry code**, press **✖** (beep).
4. Repeat steps 2 and 3 to enter additional entry codes. (You cannot duplicate entry codes)
5. Press **0** **#** together to end this programming sequence (beeeeeep).

3.7.2 Delete Entry Codes

1. Press **✖** **0** **2** and enter your four-digit MASTER CODE **?** **?** **?** **?** (beep).
2. Enter the existing **directory code** (section 3.5.2 or 3.5.4) that the desired entry code has been assigned to (1, 2, 3 or 4 digits, section 3.5.1), then press **✖** (beep).
3. Enter **#** **#** **#** **#**, then press **✖** (beep).
4. Repeat steps 2 and 3 to delete additional desired entry codes.
5. Press **0** **#** together to end this programming sequence (beeeeeep).

3.7.3 Entry Code Ranges

Four-digit entry codes can be made to activate relay 0, relay 1, or relay 2 or any combination of relays by programming **HI** and **LOW** ranges for each relay. Ranges between relays may overlap, which will cause more than one relay to activate if this is desired. For example, if the low boundary for relay-0 and relay 1 is 2000, and the hi boundary is 3000 for relay 0 and 4000 for relay 1, then entry codes between 2000 and 3000 will activate both relays, and entry codes between 3001 and 4000 will only activate relay 1.

1. Press **✖** **1** **2** and enter your four-digit MASTER CODE **?** **?** **?** **?** (beep).
2. Press **0** **✖** (beep) to set **relay 0**, or **1** **✖** (beep) to set **relay 1**, or **2** **✖** (beep) to set **relay 2** boundary.
3. Enter the **four-digit LOW boundary**, then press **✖** (beep).
4. Enter the **four-digit HI boundary**, then press **✖** (beep).
5. Repeat steps 2, 3, and 4 to set the other relay boundaries.
6. Press **0** **#** together to end this programming sequence (beeeeeep).

3.8 Anti-Pass Back

The programming steps below will allow you to set up and program **some basic functions** for the anti-pass back feature (APB). However, **you must set up the IN and OUT relay programming table in the Remote Account Manager software**. Anti-Pass Back tables **cannot** be set from the 1838 keypad. Refer to “Remote account manager for windows” manual 1835-066.

3.8.1 Programming the Anti-Pass Back Mode

Anti-Pass Back (APB) can be set to operate in one of **three different modes**. **PASSIVE APB** records an APB Violation and **will allow** entry or exit. **ACTIVE APB** records an APB Violation and **will not allow** entry or exit. **TRAP APB** records an APB Violation and **will allow entry but not exit**.

1. Press **✖ 4 3** and enter your four-digit MASTER CODE **?? ??** (beep).
2. Enter **0** for OFF, **1** for PASSIVE, **2** for ACTIVE or **3** for TRAP, then press **✖** (beep).
3. Press **0 #** together to end this programming sequence (**beeeeeep**).

3.8.2 Re-Sync All Devices

This programming step is used to **allow all cards one ‘move’** either in or out without causing an APB Violation to be recorded.

1. Press **✖ 4 5** and enter your four-digit MASTER CODE **?? ??** (beep).
2. Press **1** to Re-Sync ALL devices or press **0** to NOT Re-Sync, then press **✖** (**beeeeeep**).
3. The programming sequence will end itself after all cards have been re-synced.

3.8.3 Re-Sync Individual Devices

This programming step is used to **re-sync a single card** only.

1. Press **✖ 4 6** and enter your four-digit MASTER CODE **?? ??** (beep).
2. Enter the **five-digit device number**, then press **✖** (beep).
3. Press **0 #** together to end this programming sequence (**beeeeeep**).

3.8.4 Reset Facility Counter

This programming step is used to **reset the facility counter**. The facility counter keeps track of the number of “IN’s” and “OUT’s” when using APB mode.

1. Press **✖ 4 8** and enter your four-digit MASTER CODE **?? ??** (beep).
2. Enter a **five-digit number** that you want the count to start at, then press **✖** (beep).
Example: to start the count at 25, enter 00025.
3. Press **0 #** together to end this programming sequence (**beeeeeep**).

SECTION 4 - ADJUSTMENTS

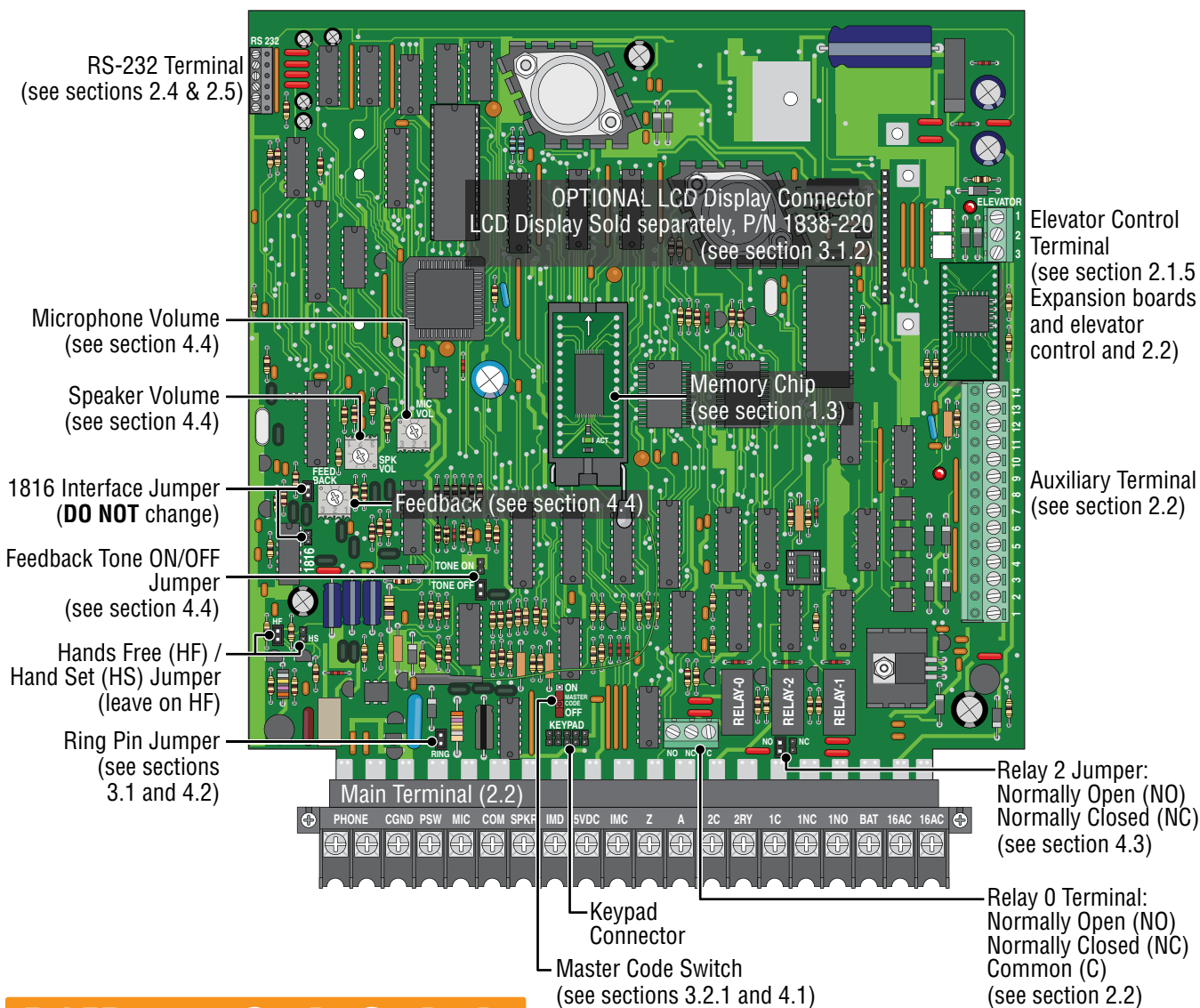

4.1 Master Code Switch

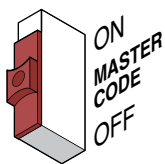

The master code switch **MUST** be kept in the **OFF** position for normal operation. Turn the master code switch **ON** only when programming the system's master code. See section 3.2.1 to program the system's master code. If the master code switch is **turned ON** and a new master code is **NOT** entered, the system will sound a long tone after approximately 30 seconds. This tone will continue every 30 seconds until a new master code is entered, or until the switch is turned off.

4.2 Ring Pin Jumper

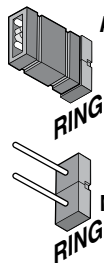

Always Answer Calls: Jumper ON

The ring pin jumper is labeled **RING** on the control board. This jumper **MUST** be installed to allow the system to **ALWAYS** answer the calls placed to it. If remote programming or remote relay operation is to be used, the jumper **MUST** be installed on the pins. Removing the jumper will cause the system to **NEVER** answer calls placed to it.

Never Answer Calls: Jumper OFF

4.3 Relay 2 Jumper

This jumper sets the contacts on relay number **TWO** at either Normally Open (NO) or Normally Closed (NC). The jumper is set to **NO** from the factory.

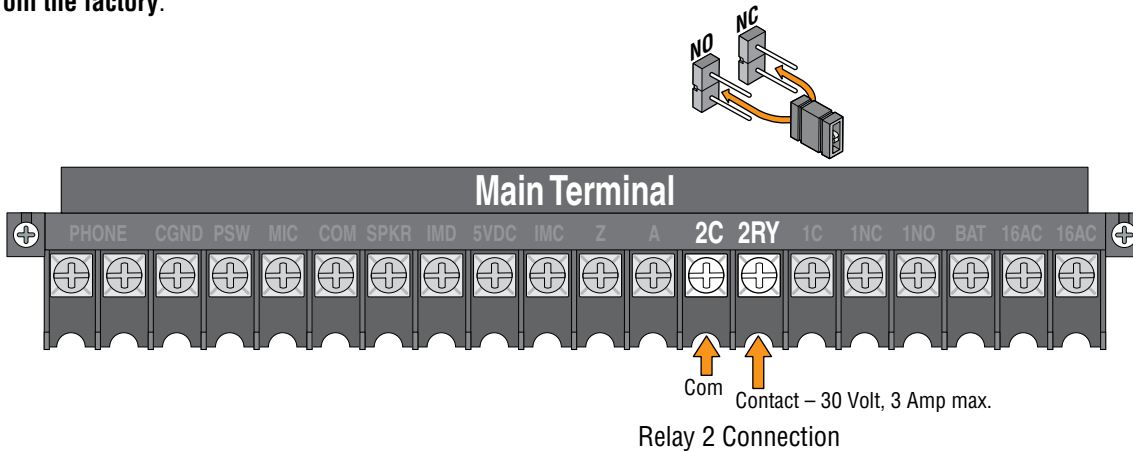

4.4 Speaker Volume, Microphone and Feedback

Speaker, microphone and feedback **ONLY** need to be adjusted when a DKS Remote Call Station is connected to the 1838. Speaker volume, microphone volume and feedback all interact with each other to affect the audio performance.



1. Locate the **speaker volume**, **microphone volume** and **feedback** adjustments on circuit board (see previous page).

2. Set the **speaker volume** about 1/3 from full counter-clockwise.



3. Set the **microphone volume** to 1/2.

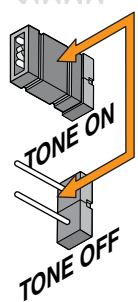

4. Place a phone call from the remote call station to a resident. If feedback occurs, turn the **speaker volume** counter-clockwise until it ceases.

5. While the resident is still on the line, ask them to remain silent. Locate and move the **feedback tone ON/OFF jumper** to to the **ON** position (see previous page). A tone will now be heard in the speaker. Rotate the **feedback** adjustment throughout its range while listening to the sound coming from the speaker. When the sound is minimum, this is the correct setting. Move the **feedback tone ON/OFF jumper** back to to the **OFF** position.

6. **Speaker volume** and **microphone volume** may now be adjusted to desired levels. If both are set too loud, feedback may result. For louder speaker volume, the microphone volume may need to be decreased. For louder microphone volume, the speaker volume may need to be decreased.



7. Normal setting for both **speaker volume** and **microphone volume** is about 1/2.

8. After setting these adjustments, place some test calls. If feedback occurs, microphone and/or speaker volume will need to be reduced.

SECTION 5 - 1838 OPERATING INSTRUCTIONS

5.1 User Instructions

5.1.1 Card Access - Card access is provided by card readers or **A**utomatic **V**ehicle Identification **D**evelopments (AVID) that can be connected to the 1838.

1. If the 1838 uses proximity type readers, present the card or PROXmtr™ to the reader by holding it close the reader head.
2. If the 1838 uses an AVID system, operation is automatic.

5.1.2 RF Transmitters - RF transmitters are typically used to control vehicular access through automated gates. Some RF transmitters, called PROXmtr's™, have a proximity card built-in that enables them to also be used as cards to access areas controlled by a card reader.

1. Press the transmitter button when in view of, and within 75 feet of the access gate.
2. PROXmtr's™ only: hold the transmitter near the proximity card reader head.

5.1.3 Five-Digit PIN Codes - Five-digit PIN (Personal Identification Number) codes should **NOT** be confused with four-digit entry codes. Although both type codes are entered on a keypad, the 1838 processes them and treats the codes in different ways.

1. Enter the 5-digit code directly on a remote wiegand keypad. A valid code will open the door or gate.

If management decides to utilize PIN codes, PIN owners should be instructed to keep their unique code secret. Telling other persons their code or allowing other persons to use their code compromises security and defeats the purpose of the 1838.

5.1.4 Four-Digit Entry Codes - Four-digit entry codes provide a means for a person to gain access by using a four-digit code entered on a remote keypad connected to the 1838 **ONLY**. The four-digit code will activate either relay 0, relay 1, relay 2 a combination of relays depending on the boundaries that have been programmed in 3.7.3.

1. First press  and then enter the 4-digit code on the remote keypad.

If management decides to utilize entry codes, Entry code owners should be instructed to keep their unique code secret. Telling other persons their code or allowing other persons to use their code compromises security and defeats the purpose of the 1838.

5.2 System Administrator

The system administrator can perform the following operations from a remote location using a touch-tone telephone if the optional telephone line has been connected to the 1838. You **MUST** know the **phone number** of the line that the 1838 is installed on and the 1838 **master code**.

5.2.1 Opening the Door / Gate From a Remote Location

1. Call the telephone number that the 1838 is installed on. The 1838 will answer with a short tone (**beep**).
2. Press ***16** and enter the **four-digit MASTER CODE** _ _ _ _ (**beep**). The beep indicates system has accepted the master code.
3. Press the desired **tone open** number _ (**beep**).
Note: Refer to section 3.3.3 to determine which tone open features have been programmed, i.e. momentary open, hold open, release, hold open one hour and then release.
4. Hang up.

5.2.2 Expansion Tracker Board Override HOLD OPEN / RELEASE Command

The Expansion board override command is used **ONLY** when expansion boards are connected to the 1838. This command will cause **ALL** expansion boards connected to the 1838 to **OPEN** or **UNLOCK** the gate or door that they are controlling, and will remain in this state until commanded to **RELEASE** the gate or door and return to normal operation. This feature is useful when management wants to open all gates or unlock all doors - perhaps during an emergency situation as an example.

Note: **HOLD** tone open number must be programmed for the override command to be functional. See section 3.3.3.

1. Call the telephone number that the 1838 is installed on. The 1838 will answer with a short tone (**beep**).
2. Press ***16** and enter the **four-digit MASTER CODE** _ _ _ _ (**beep**).
3. Press the **hold** tone open number that was programmed in section 3.3.3 _ (**beep**).
4. Hang up.
5. To release the **hold** command and return the 1838 to normal operation, repeat steps 1 through 4. In step 3, enter the **RELEASE** tone open number in place of the **HOLD** tone open number.

5.2.3 Relay Check

The 1838 can be called and a check can be made to determine if any of the relays are in a "**HOLD open**" mode. This check can be useful if your gate (or door) is held open and you suspect that one of the 1838 relays may be the cause.

1. Call the telephone number that the 1838 is installed on. The 1838 will answer with a short tone (**beep**).
2. Press ***16** and enter the **four-digit MASTER CODE** _ _ _ _ (**beep**).
3. The 1838 will emit a series of short tones if the relay is in a **continuous activation mode**:
Relay 1 activated: **beep** - pause - **beep** - pause . . .
Relay 2 activated: **beep beep** - pause - **beep beep** - pause . . .
Relay 0 activated: **beep beep beep** - pause - **beep beep beep** - pause . . .
4. Press the programmed tone open number _ to **release** the relay (**beep**). The 1838 will automatically hang up.

Note: **Release** tone open number must be programmed to deactivate the relay. See section 3.3.3.

5.2.4 Control Relays Directly from PC

If **Remote Account Manager** software is being used to program the 1838, then the PC can operate any of the relays directly. Refer to **Remote Account Manager** software to operate the desired relays. This is **ONLY** available on 1838 circuit boards "**Rev Z**" or higher. Older 1838s **cannot** directly operate relays from the PC.

SECTION 6 - MAINTENANCE

The DoorKing access controller system is essentially a maintenance free device. When the unit is properly installed, it should provide years of trouble free service. Maintenance is limited to updating the directory and phone number and/or entry codes when residents move in or out.

6.1 Troubleshooting

If problems should develop with your 1838, refer to the trouble-shooting guide on the following pages to try and correct any problems. Our experience has shown that a majority of reported problems are actually programming related and can be corrected on site. If problems persist and they cannot be corrected, contact your authorized DoorKing dealer for assistance. Before performing any trouble-shooting, check the following:

1. Have a good VOM meter handy to check voltages and continuity.
2. Have a telephone test set (DoorKing P/N 1800-050 or equivalent) to check the telephone line. Noise on the phone line will cause problems with the entry system.
3. Be sure that the entry system case is properly grounded.
4. Be sure that the telephone wires are twisted.
5. A hum on the system indicates that the phone line or 16.5 VAC power lines may be grounded. Check to be sure that the phone lines or power lines are not shorted to ground.
6. Check the 16.5 VAC system power. Be sure that the transformer is properly rated (20 VA). Keep the wire run from the transformer to the entry system as short as possible. Use 16 or 18 AWG, 600 volt insulated wire only. The importance of proper power wiring cannot be over stressed!
7. Isolate the access controller. Disconnect any external devices, such as expansion boards, elevator control boards, RS 232 connection, card readers, RF receivers, keypads, etc. which may affect the operation of the system.

Symptom	Possible Solution(s)
Cannot get into programming mode.	<ul style="list-style-type: none">• Wrong master code entered. Start over.• Waiting too long between pushing buttons. Enter information quicker.• Keypad is not plugged into board correctly. Cable points to the left.• Memory chip is installed upside down.
System emits a long tone and cancels programming.	<ul style="list-style-type: none">• Waiting too long between pushing buttons.• Forgetting to press # first when programming.
Keypad is dead.	<ul style="list-style-type: none">• No power. Check for 16.5 VAC input power.• Check that the keypad is properly connected to the circuit board. The cable on the plug points to the left when connected to the circuit board.

Symptom	Possible Solution(s)
Buzz or noise on the phone line.	<ul style="list-style-type: none"> • Disconnect the phone line from the system and check it with a handset. If line is noisy, problem is with the phone line and not the entry system. • Check for any shorts to ground behind the circuit board. • Check for pinched wires near the door hinge. • Check for 16-volt power shorted to ground. • Check for phone line shorted to ground. • Check that phone wires are twisted. • Check that the proper type of phone wire was used for an outdoor and / or underground application. • Check that all wires, speaker, keypad, etc. are isolated from ground. • Check that the cabinet is properly grounded. Be sure that case ground (terminal 3) is not used as a low voltage common. • Check for excessive voltage drop on 16 VAC power.
Ringing or howling from the speaker.	<ul style="list-style-type: none"> • Feedback improperly adjusted (4.4). • Volume is set too high (4.4).
Door strike locks on.	<ul style="list-style-type: none"> • Excessive voltage-drop on 16 VAC line. • Using a transformer with too low VA rating. • Relay strike time programmed too long (3.3.1).
Door strike or gate operator holds open.	<ul style="list-style-type: none"> • System was given a hold open command. Call the system and press the tone open deactivate number (3.3.3).
Controller will not answer when called.	<ul style="list-style-type: none"> • Ring pin is not installed (4.2). • Bad phone line or insufficient ring voltage.
Touch-tone 9 will not activate relay.	<ul style="list-style-type: none"> • Re-program tone-open number to 9 (3.3.3). • If resident phone emits a short pulse rather than a long tone, press 9 twice in rapid succession "99". • Try another phone that is known to work. • Lower speaker volume (4.4) and re-adjust feedback (4.4).
Relay activates but gate operator will not open.	<ul style="list-style-type: none"> • Re-program relay strike time for a longer period (3.3.1). • Check wiring to gate operator. • Check gate operator.
Postal switch will not activate relay.	<ul style="list-style-type: none"> • Be sure that the wire-tie has been clipped off the postal switch. • Be sure that the relay has been programmed for postal switch input (3.3.4). • Be sure postal switch is connected properly.
Four-digit entry codes will not work.	<ul style="list-style-type: none"> • Forgetting to press "#" first. • Re-program the entry code ranges (3.7.3).
Entry codes will not activate relay 0.	<ul style="list-style-type: none"> • Re-program relay 0 low and high ranges (3.7.3).
Entry codes will not activate relay 1.	<ul style="list-style-type: none"> • Re-program relay 1 low and high ranges (3.7.3).
Entry codes will not activate relay 2.	<ul style="list-style-type: none"> • Re-program relay 2 low and high ranges (3.7.3).
System emits a beep every 30 seconds.	<ul style="list-style-type: none"> • Master code switch is in the ON position (4.1).
System emits 3 short beeps when powered up.	<ul style="list-style-type: none"> • The small chip in the PC board socket is for an older access control system and can not be used in the access control system. (1.3).

6.1.1 RS-232 Test

This test procedure will check the RS-232 hardware to determine a **PASS** or **FAIL** mode. You will need two short pieces of wire to perform this test (jumpers). Connect the jumper wires as shown to the RS-232 terminal.

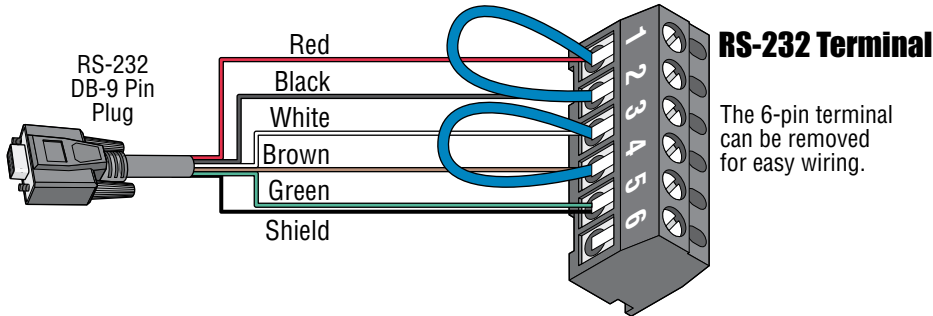

1. Press and enter your four-digit MASTER CODE (beep).
2. Press (beep).

PASS - The LCD display will indicate: **RS232 HARDWARE PASS**. One long tone will be heard: (**Beeeeeeep**).

FAIL - The LCD display will indicate **RS232 HARDWARE FAIL**. Two short tones and a long tone will be heard: (**Beep - Beep - Beeeeeeep**).

3. Remove the jumper wires from the terminal after performing this test.

6.1.2 Wiegand Test - Optional LCD Display Must be Installed

This programming sequence will allow you to view the wiegand data on the **OPTIONAL** LCD display (P/N 1838-220) as it is received by the control board. This will allow you to verify that the 26, 30 and 31-bit wiegand device is functioning properly.

1. Press and enter your four-digit MASTER CODE (beep).
2. Enter .
3. Activate one of the wiegand input devices by placing a card on a card reader, pressing a transmitter button, or entering a digital code on a wiegand keypad.
4. If the wiegand data is shown on the **OPTIONAL** LCD display, this verifies that the wiegand device is operating properly and sending the information to the 1838. If **NO** data appears on the display, the wiegand devices are **NOT** functioning.
5. Press to cancel the wiegand test mode. (**beeeeeep**).

6.1.3 Elevator Board(s) Hardware Test - Optional LCD Display Must be Installed

This programming sequence is designed for troubleshooting the elevator control board(s) that may be connected to the 1838. This sequence will take approximately four (4) minutes to complete and will check the operation of the CALL relay, all the odd numbered relays, then all the even numbered relays on the elevator control board(s). This test confirms communication between the 1838 circuit board and the elevator control board(s). **OPTIONAL** LCD display (P/N 1838-220) needed.

1. Press and enter your four-digit MASTER CODE (beep).
2. The **OPTIONAL** LCD display will show: **WHICH ELEVATOR?**
3. Enter the elevator shaft number (1, 2, 3 or 4) _, then press (beep).

The **OPTIONAL** LCD display will show: **ELEVATOR TEST 1**.

Once the test starts, the CALL relay (**LED ON**) will activate, then **ALL odd numbered relays** will activate. After that, **ALL even numbered relays** will activate on the 1st elevator control board. After this sequence, if more than one elevator control board is connected, ALL odd numbered relays, and then ALL even numbered relays will activate on the 2nd elevator control board. This sequence will repeat itself up to ten (10) times depending on the number of elevator control boards connected.

4. Once the test is complete (approximately 4 minutes), this programming sequence will automatically end itself.

6.1.4 Elevator Board / Floor Hardware Test - Optional LCD Display Must be Installed

This testing sequence will allow you to check activation of individual relays on the elevator control board(s) and will confirm communication between the 1838 circuit board and the elevator control board(s). **OPTIONAL** LCD display (P/N 1838-220) needed.

1. Press **[*][7][7]** and enter your four-digit MASTER CODE **[?][?][?][?]** (beep).

The **OPTIONAL** LCD display will show: **WHICH ELEVATOR?**

2. Enter the elevator shaft number (1, 2, 3 or 4) **[]**, then press **[*]** (beep).

The **OPTIONAL** LCD display will show: **FLOOR?**

3. Enter the **two-digit floor number** **[][]**, then press **[*]** (beep).

Note: First floor is entered 01, fifth floor is entered 05 etc.

4. The relay LED on the elevator control board that represents the floor number entered will **turn ON** for approximately 1 second.

5. To check other floor relays, repeat steps 2 and 3.

6. Press **[0][#]** TOGETHER to end this programming sequence (**beeeeeep**).

Note: This program test sequence will automatically end itself if no keypad inputs are detected after approximately 30 seconds.

Refer to the Elevator Control board installation manual for more information on troubleshooting the elevator control boards.

6.1.5 Automatic Hang-up Options - Optional LCD Display Must be Installed

This sequence will allow you to program different methods by which the 1838 will hang-up if a resident denies a guest access by hanging up their telephone rather than pressing the “#” key to terminate the call.

Factory setting is 1, dial tone detect ON. OPTIONAL LCD display (P/N 1838-220) needed.

1. Press **[*][4][0]** and enter your four-digit MASTER CODE **[?][?][?][?]** (beep).

The **OPTIONAL** LCD display will show: **0=N 1=DT 2=SIL 3=BTH.**

0 – BOTH OFF. Unit hangs up after programmed strike time runs out.

1 – DIAL TONE detect ON. Unit hangs up after detecting 5-seconds of dial tone.

2 – SILENCE detect ON. Unit hangs up after detecting 15-seconds of silence.

3 – BOTH ON.

2. Enter the **hang-up option code** **[]** (0, 1, 2 or 3), then press **[*]** (beep).

3. Press **[0][#]** TOGETHER to end this programming sequence (**beeeeeep**).

6.1.6 Modem Output Level Adjustment

This programming step should only be used if you are experiencing modem trouble. It allows you to adjust the output level of the modem tones. A higher modem level number increases the tone volume while a lower number decreases tone volume. 1-Min, 8-Max.

Factory setting is 4.

1. Press **[*][9][0]** and enter your four-digit MASTER CODE **[?][?][?][?]** (beep).

2. Enter the single-digit modem level number (1-8), then press **[*]** (beep).

3. Press **[0][#]** TOGETHER to end this programming sequence (**beeeeeep**).

6.1.7 Display DKS Data over IP Phone Number or ID Number - Optional LCD Display Must be Installed

This will allow you to see the **DKS Data over IP** issued 10-digit phone number or system ID number that has been programmed into the 1838. **OPTIONAL** LCD display (P/N 1838-220) needed.

1. Press *** 5 6** and enter your four-digit MASTER CODE **? ? ? ?** (beep).

The **OPTIONAL** LCD display will show the 10-digit phone number or system ID number.

Note: The display will show C's (C C C C C C C C C C) if a phone number or ID has **NOT** been programmed.

6.1.8 Test Connection to DKS Data over IP - Optional LCD Display MUST be Installed

This will allow you to test the connection to the **DKS Data over IP** or display problems that may have occurred. **OPTIONAL** LCD display (P/N 1838-220) needed.

1. Press *** 2 9** and enter your four-digit MASTER CODE **? ? ? ?** (beep).

The **OPTIONAL** LCD display will show one of the following and the 1838 will BEEP accordingly:

System is Registered - (beep) one beep

- System is registered and communication to the **DKS Data over IP** is good.

Check Registration - (beep-beep) two beeps

- Make sure your registration is current and this system is set to **DKS Data over IP** on the registration screen. Also, be sure that the system phone number or ID number and the master code are set the same on the **DKS Data over IP** and the 1838.

Program 10 Digit ID - (beep-beep-beep) three beeps

- There is not a valid 10-digit ID in the system memory. (see section 3.2.10)

Turn DKS Data over IP On - (beep-beep-beep-beep) four beeps

- There is a valid 10-digit ID, but **DKS Data over IP** is turned OFF. (see section 6.1.9)

No DKS Data over IP Contact - (beep-beep-beep-beep-beep) five beeps

- Communication to **DKS Data over IP** could not be made.

Note: If there is pending data to be transferred when this test is performed, the data transfer will occur.

6.1.9 Turn DKS Data over IP OFF or ON

Use the following sequence to turn **DKS Data over IP OFF** or **ON**.

If you are going to use the RS232 connection for any other RS232 functions other than **DKS Data over IP** (e.g., connecting a PC directly to the entry system via the RS232 terminal), **DKS Data over IP** must be turned **OFF**.

The **DKS Data over IP** must be **ON** to use the system with **DKS Data over IP**. **Note:** When section 3.2.10 (**DKS Data over IP** Phone Number or System ID Number) is programmed, **DKS Data over IP** is automatically turned **ON**.

If there is **NOT** a valid 10 digit system phone number or system ID number in memory, the system will emit three (3) short beeps. **Beep ... Beep ... Beep**

1. Press *** 5 5** and enter your four-digit MASTER CODE **? ? ? ?** (beep).

2. Press **0 *** (beep) to turn **OFF**, OR **1 *** (beep) to turn **ON**.

3. Press **0 #** together to end this programming sequence (**beeeeeep**).

Note: You can test the 1838 connection to **DKS Data over IP** and analyze problems that may occur using section 6.1.8.

6.2 Accessories

Plug-In LCD Display Screen: Plug-in LCD display for the 1838. P/N 1838-220.

Remote Call Stations: Provides voice communication to a remote location via the telephone network.

With Keypad. P/N 1838-120.

With AWID card reader. P/N 1838-122.

With HID card reader. P/N 1838-123.

With DK Prox card reader. P/N 1838-124.

Note: When connecting two call stations together, P/N 1494-010 microphone combiner is needed.

Intercom Stations:

With Keypad. P/N 1504-120.

With AWID card reader. P/N 1504-122.

With HID card reader. P/N 1504-123.

With DK Prox card reader. P/N 1504-124.

RF Devices:

RF devices (transmitters/receivers) provide remote access control for vehicular gates.

DoorKing MicroPLUS™ wiegand receiver P/N 8056-080 and corresponding transmitters.

DoorKing MicroCLIK wiegand receiver P/N 8059-080 and corresponding transmitters.

PROXmtr™:

Provides both RF access control AND proximity card access control.

Requires a MicroPLUS wiegand receiver and DKS, AWID or HID proximity card readers.

Digital Keypads:

Mounts in single-gang electric box. P/N 1815-053 silver, P/N 1815-054 black.

Surface mount enclosure. P/N 1815-059.

Surface mount lighted enclosure. P/N 1815-051.

Flush mount lighted enclosure. P/N 1815-052.

Digital Keypads and Intercom/Card Reader:

Wiegand keypad plus built in intercom substation. P/N 1504-120.

Wiegand keypad and AWID card reader. P/N 1815-248.

Wiegand keypad and HID card reader. P/N 1815-249.

Wiegand keypad and DK Prox card reader. P/N 1815-250.

Secondary Keypad: Provides for use of 4-digit entry codes. P/N 1814-075.

Tracker Expansion Board

Expansion boards (P/N 2358-010) allow the 1838 to operate up to 48 individual doors or gates, provides door ajar and forced entry alarms, and can activate local and building alarm systems. Also allows DoorKing gate operators to report gate operator data and activity to the 1838.

Elevator Board

Elevator control boards provide control of up to four elevators, with each elevator having a maximum of 64 floors. P/N 2348-010.

RS-232 Cable

RS-232 cable with DB-9 connector on one end and wires on the other end. Use this cable to program the entry system from a PC using RS-232 communications instead of the modem. P/N 1818-040.

Telephone Test Set

Includes clips, cord and carrying case. P/N 1800-050.

Battery

12 volt .8 amp hour gel cell provides stand by power during power interruptions. P/N 1801-008.

1838 Communication Connection Options

DKS Cellular Kit - DKS Cellular Server Connection

Enables the 1830 series system to send and receive data and voice to a PC via DKS Cellular network. Voice/Data P/N 1800-080

TCP/IP Converter Kit - Third Party Connection

Enables the 1830 series system to send and receive data via the Internet or a LAN. P/N 1830-185.

TCP/IP Converter Kit - DoorKing DKS Data over IP Connection

Enables the 1830 series system to send and receive data via DKS Data over IP. P/N 1830-186.

1830 Series VoIP/RS-232 Control Box

Enables the 1830 series system to send and receive data and voice via DKS over IP. P/N 2334-080.

VoIP Adapter Kit

Enables the 1830 series system to send and receive voice via DKS VoIP over IP. P/N 1815-568

RS-422 Adapter Kit

Enables the 1830 series system to send and receive data to a PC. P/N 1840-055.

1838 Wiring Schematic

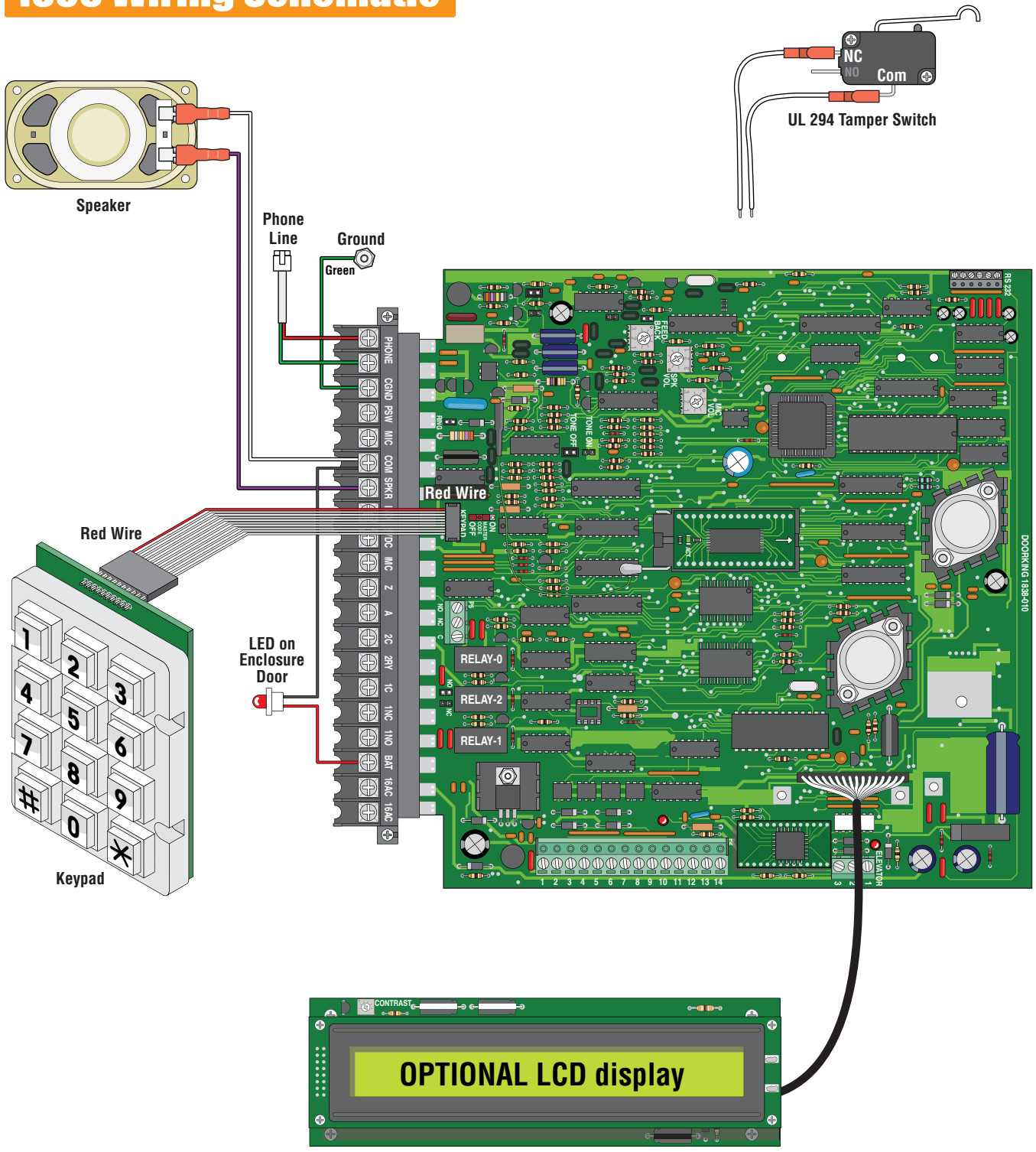

Sold Separately P/N 1838-220

SECTION 7 - LOG TABLES

Complete the information in the tables on the following pages to maintain a record of the information that has been programmed into the 1838 if the system **IS NOT being programmed from a PC**. If PC programming is being utilized, there is **no reason** to maintain these log sheets since the PC will maintain a complete record of the information that has been programmed. Make copies of the resident log sheet (section 7.2) so that you have enough to complete a listing of all residents and data. Enter the information as shown in the example below.

AAC stands for Alternate Area Code. Enter the alternate area code number if alternate area codes have been programmed and assigned to this resident (section 3.5.3).

DIRECTORY CODE is the resident's unique directory code. It can be 1 to 4 digits (section 3.5.1).

ENTRY CODE is the resident's four-digit entry code (section 3.7.1) if they are used.

DEVICE CODE is the resident's unique device code (section 3.6.1) if access control devices (Transmitters, cards, etc.) are used.

ELEVATOR USE ONLY (Remote Account Manager Software **MUST** be used):

SEC LEVEL (Security Level).

FL (Floor).

ER (Elevator Reference Number).

Resident Log Sheet Example

Name	AAC	PHONE NUMBER	DIRECTORY CODE	ENTRY CODE	DEVICE CODE	ELEVATOR USE		
						SEC LEVEL	FL	ER
Smith, John	3	765-0000	173	3812	04231	02	14	2

7.1 Programming Information Tables

Master Code (section 3.2.1)			
1st Digit	2nd Digit	3rd Digit	4th Digit

Relay Strike Time (section 3.3.1)		
Relay 0	Relay 1	Relay 2

Tone Open Numbers (section 3.3.3)	Relay 0	Relay 1	Relay 2
Momentary Activation			
Relay Hold OPEN			
Relay RELEASE			
Relay Hold OPEN 1 Hour			

Entry Code Ranges (section 3.7.3)	Relay 0	Relay 1	Relay 2
Low Boundary			
High Boundary			

Postal Lock Activates (section 3.3.4)		
Relay 0	Relay 1	Relay 2

Note: Requires Postal Lock Box connected to main terminals 4 and 6. See sections 1.4 and 2.3.

Rotary "9" Activates (section 3.3.6)		
Relay 0	Relay 1	Relay 2

7.1.1 10 Area Codes

Area Code Pointers - System Set to 10 Area Codes (section 3.5.3)									
Pointer	Area Code	Pointer	Area Code	Pointer	Area Code	Pointer	Area Code	Pointer	Area Code
1		3		5		7		9	
2		4		6		8		0	

7.1.2 255 Area Codes - Page 1

Area Code Pointers - System Set to 255 Area Codes (section 3.5.3)									
Pointer	Area Code	Pointer	Area Code	Pointer	Area Code	Pointer	Area Code	Pointer	Area Code
001		027		053		079		105	
002		028		054		080		106	
003		029		055		081		107	
004		030		056		082		108	
005		031		057		083		109	
006		032		058		084		110	
007		033		059		085		111	
008		034		060		086		112	
009		035		061		087		113	
010		036		062		088		114	
011		037		063		089		115	
012		038		064		090		116	
013		039		065		091		117	
014		040		066		092		118	
015		041		067		093		119	
016		042		068		094		120	
017		043		069		095		121	
018		044		070		096		122	
019		045		071		097		123	
020		046		072		098		124	
021		047		073		099		125	
022		048		074		100		126	
023		049		075		101		127	
024		050		076		102		128	
025		051		077		103		129	
026		052		078		104		130	

7.1.2 255 Area Codes - Page 2

Area Code Pointers - System Set to 255 Area Codes (section 3.5.3)									
Pointer	Area Code	Pointer	Area Code	Pointer	Area Code	Pointer	Area Code	Pointer	Area Code
131		157		183		209		235	
132		158		184		210		236	
133		159		185		211		237	
134		160		186		212		238	
135		161		187		213		239	
136		162		188		214		240	
137		163		189		215		241	
138		164		190		216		242	
139		165		191		217		243	
140		166		192		218		244	
141		167		193		219		245	
142		168		194		220		246	
143		169		195		221		247	
144		170		196		222		248	
145		171		197		223		249	
146		172		198		224		250	
147		173		199		225		251	
148		174		200		226		252	
149		175		201		227		253	
150		176		202		228		254	
151		177		203		229		255	
152		178		204		230		000	
153		179		205		231			
154		180		206		232			
155		181		207		233			
156		182		208		234			

RESIDENT INSTRUCTIONS



Your building / community has been equipped with a **DoorKing Access Control System** that will provide communication for your guest from the lobby door / gated entrance to your home. If you have any questions regarding the use or operation of this system, please see your **System Administrator** (building manager / HOA representative) or **Call:**

Phone # _____

Guest Communication: A resident directory of some kind is usually located near the main entrance next to the remote call station. A **DIRECTORY CODE** is issued next to your name/apt. number etc. This directory code can be from 1 to 4 digits long. When a guest comes to visit you, they will look up your name/apt. number etc in the resident directory and find YOUR **DIRECTORY CODE**. Your guest will enter YOUR **DIRECTORY CODE** on the remote call station keypad that will then place a call to your home (If your guest already knows YOUR specific directory code, they can simply enter the code on the keypad without having to look up your code in a resident directory). A guest **CANNOT** enter your telephone number on the keypad, it **MUST** be the **DIRECTORY CODE ONLY!**

Granting or Denying Access to your Guest: Once you have answered the phone call and you have identified your guest, you have the choice to either **grant access** or **deny access** to your guest.

Touch-Tone Phones ONLY.

To **GRANT ACCESS** to your guest, press on your touch-tone telephone. The Access Control System will respond with a confirmation tone indicating that the door or gate is opening and will automatically disconnect itself. Some newer telephones emit a very short duration tone when the number is pressed. If your telephone does this, you may have to press the "GRANT ACCESS NUMBER" twice in rapid succession to open the door or gate.

To **DENY ACCESS** to your guest, press the "#" key on your touch-tone telephone.

Rotary-Dial Phones ONLY.

To **GRANT ACCESS** to your guest, dial "9".

To **DENY ACCESS** to your guest, **hang-up** your phone.

Call Waiting: If you are on your telephone when a guest tries to contact you from a remote call station, they will hear a busy signal and will have to wait for you to end your call before they can contact you. **To eliminate this problem**, you can order call waiting from your local telephone company.

Privacy: A resident directory may be used near the main entrance if guests can call residents (remote call station) from there. If you **DO NOT** want your name and/or apartment number listed in the resident directory, inform the system administrator of this. If you choose to do this, you will need to inform your guest what **YOUR directory code** is, otherwise there will be **NO WAY** for them to identify **YOUR** directory code on the resident directory.

5-Digit PIN Number: You may be issued a "5-digit PIN number" that will allow you to open a door / gate by entering this PIN number on a remote keypad near a separate entry point(s). Your system administrator will advise you of **YOUR** PIN number and where it can be used if this option is available.

PIN Number

To use your PIN number, enter your **5-digit code** on the remote keypad near an entrance(s) your system administrator will advise you of.

4-Digit Entry Code: You may be issued an "entry code" that will allow you to open the **MAIN** door / gate by entering this code on a remote call station's keypad near the main entrance **ONLY**. Your system administrator will advise you of **YOUR** 4-digit entry code if this option is available.

Entry Code

To use your access code, **first** press the key on the remote keypad near the main entrance, then enter your **4-digit code**.

System Administrator's Note: Fill in phone number, access granted number ,PIN and entry code numbers, copy and distribute this to residents.



Download **REMOTE ACCOUNT MANAGER** Software **FREE** at:
<http://www.doorking.com/telephone/software>

www.doorking.com

Version G

DoorKing, Inc.
120 S. Glasgow Avenue
Inglewood, California 90301
U.S.A.

Phone: 310-645-0023
Fax: 310-641-1586