

Installation/Owner's Manual

1603

Barrier Gate Operator with Auto Spike System

Use this manual for circuit board 1601-010 Revision AK or higher.

1603-065-P-10-24

THIS PRODUCT IS TO BE INSTALLED AND SERVICED BY A TRAINED GATE SYSTEMS TECHNICIAN ONLY.
Visit www.dkslocator.com to find a professional installing and servicing dealer in your area.

CAUTION: Installation and use of traffic control spike unit in areas that are subject to freezing weather with the potential of snow and ice accumulation is not recommended. The unit may freeze in the up position and cause unintended injury or damage due the inability of the spikes to retract.

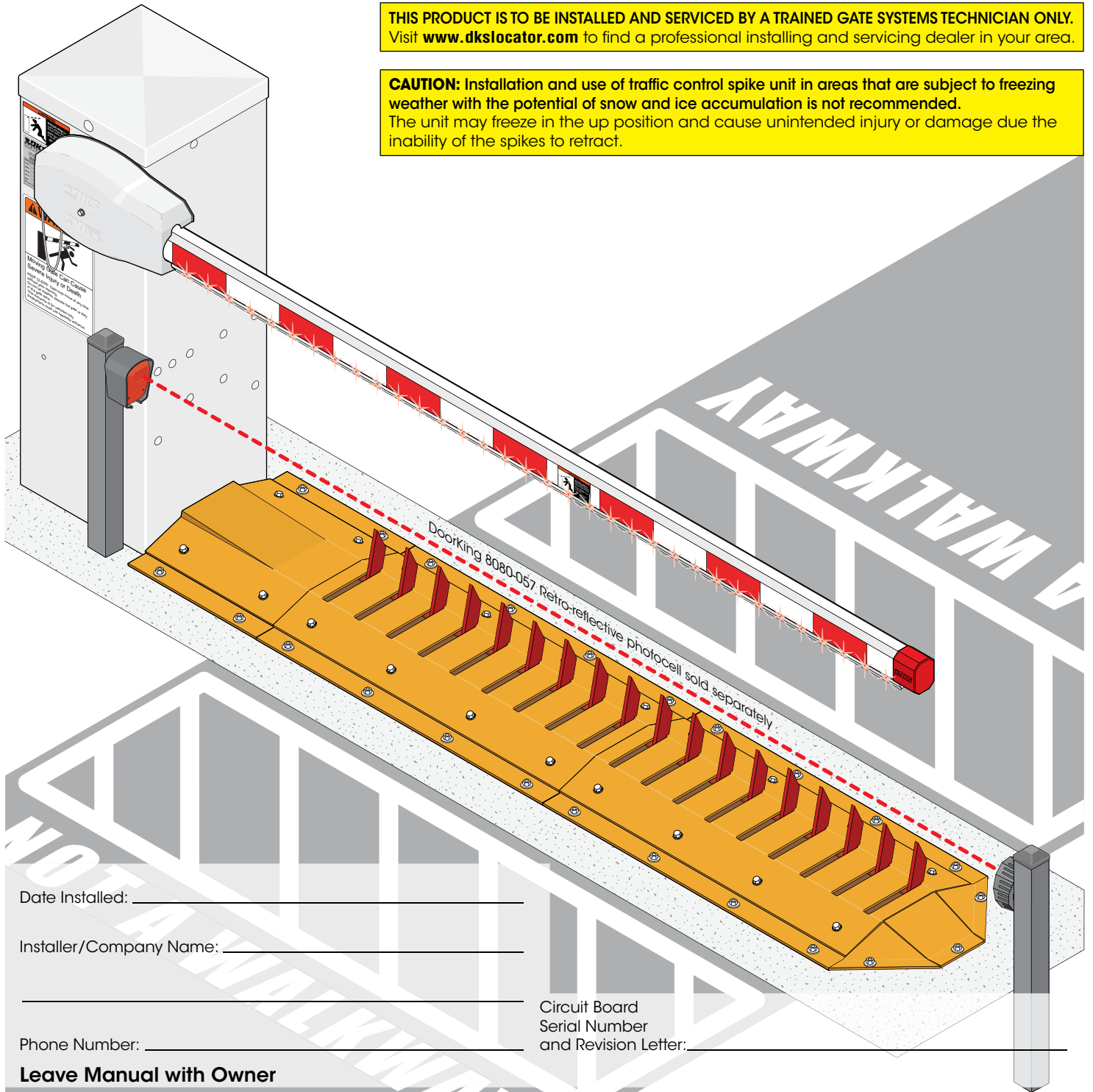

Date Installed: _____

Installer/Company Name: _____

Phone Number: _____

Circuit Board
Serial Number
and Revision Letter: _____

Leave Manual with Owner

Copyright 2024 DoorKing®, Inc. All rights reserved.



Listed to ANSI/CAN/UL 325



UL 325 Entrapment Protection

UL 325 Classifications



Class I - Residential Vehicular Gate Operator

A vehicular gate operator (or system) intended for use in garages or parking areas associated with a residence of one-to four single families. This does **NOT** apply to a vertical barrier arm.



Class III - Industrial/Limited Access Vehicular Gate Operator

A vehicular gate operator (or system) intended for use in an industrial location or building such as a factory or loading dock area or other locations not accessible by or intended to service the general public.

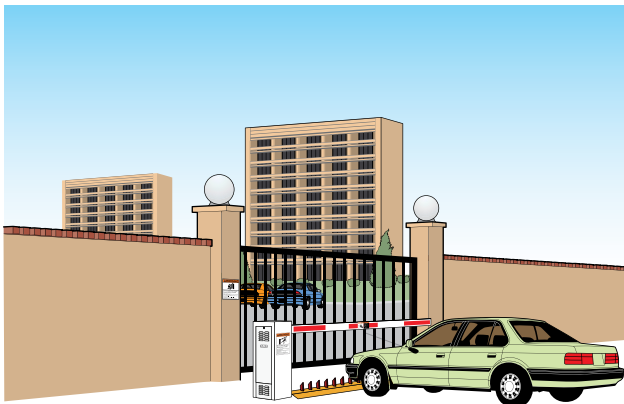

Class II - Commercial/General Access Vehicular Gate Operator

A vehicular gate operator (or system) intended for use in a commercial location or building such as a multi-family housing unit (five or more single family units), hotel, garages, retail store, or other buildings accessible by or servicing the general public.

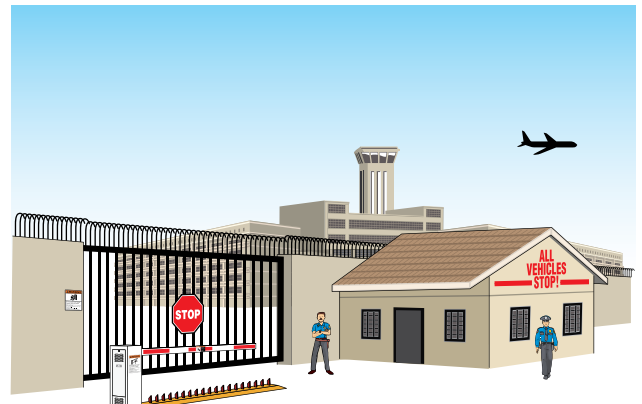

Class IV - Restricted Access Vehicular Gate Operator

A vehicular gate operator (or system) intended for use in a guarded industrial location or building such as an airport security area or other restricted access locations not servicing the general public, in which unauthorized access is prevented via supervision by security personnel.

Gate Operator Category

	Horizontal Slide, Vertical Lift, Vertical Pivot, Horizontal Bifold	Swing, Vertical Barrier (Arm)
Entrapment Protection Types	A, B1*, B2* or D	A, B1*, B2*, C or D

Type A - Inherent entrapment protection system.

Type B1 - Non-contact sensor (photoelectric sensor or the equivalent).

Type B2 - Contact sensor (edge device or equivalent).

Type C - Inherent force limiting, inherent adjustable clutch or inherent pressure relief device.

Type D - Actuating device requiring constant pressure to maintain opening or closing motion of the gate.

* B1 and B2 means of entrapment protection must be MONITORED.

Vertical Barrier Note: Barrier gate operators (arm) that is not intended to move toward a rigid object closer than 16 inches (406 mm) are not required to be provided with a means of entrapment protection.

Safety Information for Vertical Barrier Arm and Spikes

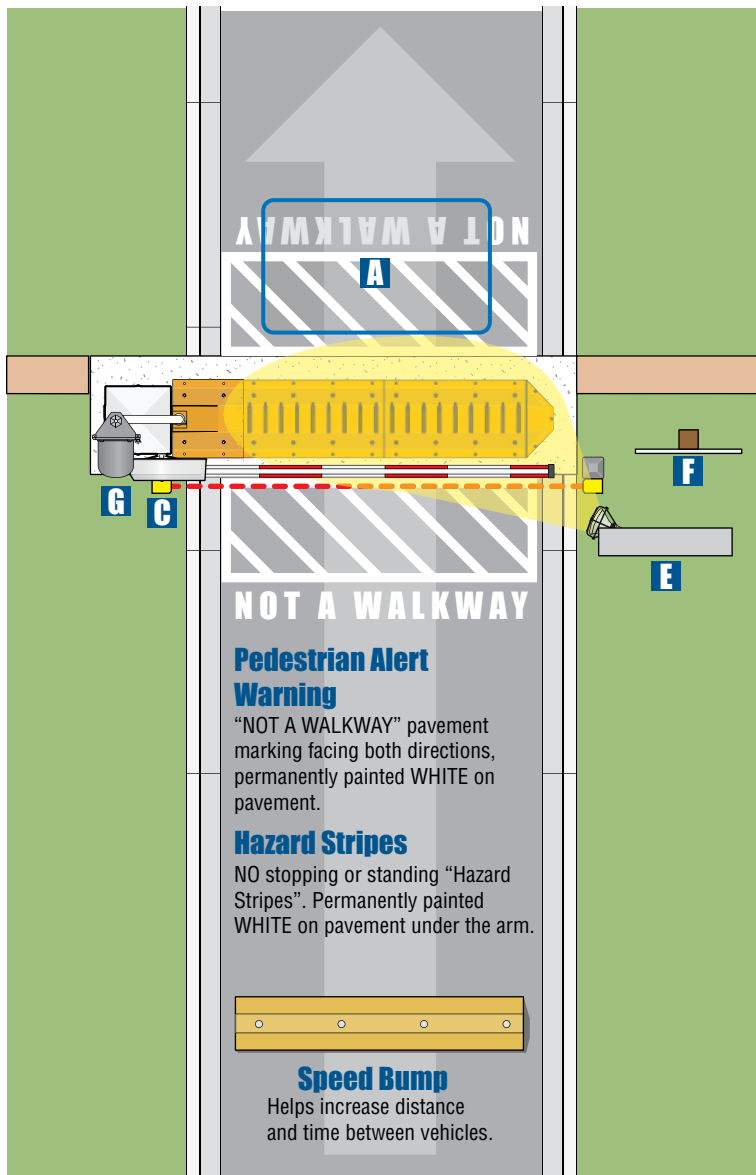

Separate Pedestrian Walkway
Located so pedestrians **CANNOT** come in contact with the barrier arm.

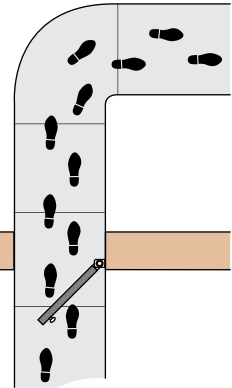

A In-Ground Loop(s)

Loops minimize the potential of the arm closing when a vehicle is present. Number and placement of loop(s) is dependent on the application.

B Warning Signs

Permanently mounted on operator and arm and easily visible. Warning signs are to be **permanently installed** in the area of the gate in such a manner that at least one warning sign is visible by persons located on each side of the gate, for both the **secure** and **unsecure** sides of the gate.



C Non-Contact Sensor

Minimizes the potential of the arm lowering on vehicular or other traffic that loops cannot sense. **Located directly under arm.**

D Contact Sensor

Minimizes the potential of the arm lowering on vehicular or other traffic that loops cannot sense.

Contact Sensor Note: A reverse edge is **NOT** to be used as a replacement, or in lieu of, in-ground loops or non-contact sensor (photocell) that protect vehicles passing underneath the barrier arm. A **moving** vehicle coming in contact with a downward moving barrier arm **WILL** result in **damage to the vehicle** and the barrier arm/reversing edge if **NOT** using in-ground loops or non-contact sensor (Photocell).

E Spike Warning and Illumination

It is extremely important that traffic spikes are installed in an area that is illuminated and clearly marked with spike warning signs (DoorKing's model 1615 illuminated warning sign kits).

F Speed Limit Sign

Helps control traffic.

G Traffic Red/Green Light

Helps control traffic.

H Arm LED Lights

Helps with arm's visibility and position.

I Warning Beeper

Used to alert pedestrians that barrier arm is cycling.

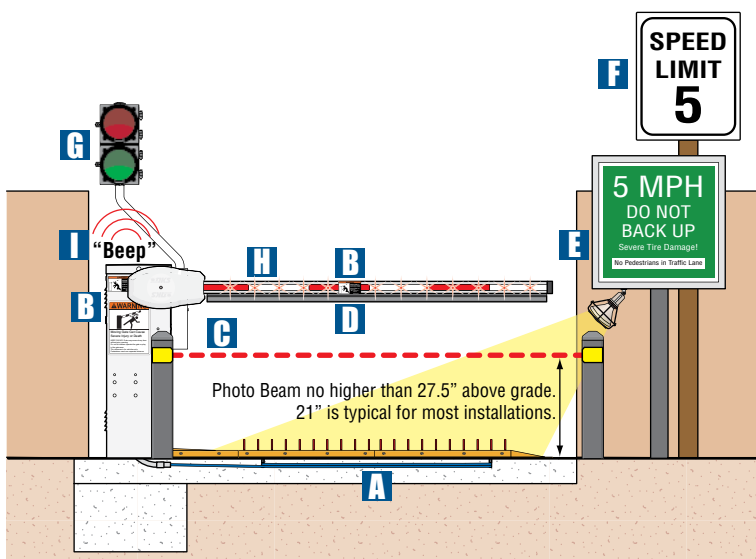

Safety Information for Vertical Barrier Arm and Spikes

Reduce the risk of injury or death, read and follow all instructions.

Familiarize yourself with safety warnings, instructions, illustrations, and wiring guidelines to ensure that the installation is performed in a safe and professional manner. **Prior to installation check all local building codes and ordinances to ensure compliance.**

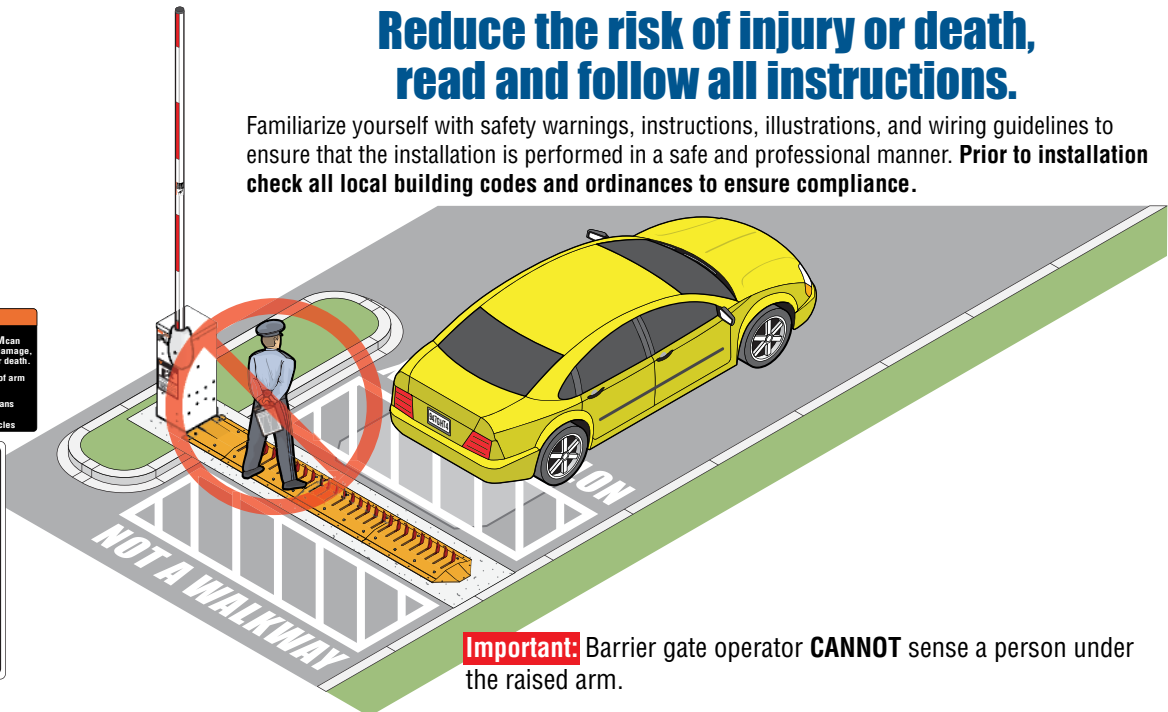

Important: Barrier gate operator **CANNOT** sense a person under the raised arm.

This scenario is VERY DANGEROUS and MUST NEVER OCCUR!!

- Make sure all warning signs are on operator and arm. Warning signs are to be permanently installed in the area of the gate in such a manner that at least one warning sign is visible by persons located on each side of the gate, for both the secure and unsecure sides of the gate.
- **Do not install the operator in such a way that the arm moves within 2 feet of a rigid object.**
- **Spike Warning.** It is extremely important that the traffic spikes are clearly marked with a warning sign of potential hazard to vehicles and the spike area is well illuminated.
- **Speed limit through barrier area is 5 MPH.** Install speed bumps, warning signs and hazard stripes where visible in the area of the barrier gate, failure to do so may result in injury, damage to operator and vehicle.
- Users should be familiar with proper use of operator, these include; hardware operation, reversing functions and testing, reversing loops, inherent reversing system, electric edges, photoelectric cells related external devices and possible hazards.
- **Keep adults, children and objects away from operator and HAZARD ZONES.**
- **Automotive traffic only - No bicycles or motorcycles. Pedestrians MUST be provided with separate access.**
- All electrical connections should be made in accordance with local electrical codes.
- Security features should be installed to **avoid unauthorized use.**
- Controls must be installed far enough away from the operator to avoid any contact when operating the controls but no further away from the operator than 50 ft. If the installed hardware is in violation of these restrictions remove the operator from service immediately and contact your service dealer.
- When manually operating the gate operator arm, the user **MUST** make sure that the gate area is clear **BEFORE** operating the controls. Any activity in the entrance and exit lanes should be monitored to ensure a safe operation when opening or closing the barrier gate. The motion of the barrier boom must be directly observable by the person operating the barrier. While the barrier boom is in motion **NO** pedestrian and **NO** vehicle shall be in the immediate vicinity of the barrier.
- When removing the operator lift the arm to the full open position and **shut off power at the service panel.**
- **Operators and components should be properly installed and maintained** following the recommended service schedule, test the operator monthly. Keep all debris away from operator housing vents and off of arm. Contact your service dealer for any maintenance or repairs.
- Vehicular operators can produce high levels of force, it is important that you are aware and **eliminate possible HAZARDS; Pinch Points, Entrapment Areas, Absence of Controlled Pedestrian Access, Traffic Backup.**

QUICK GUIDE: Terminal Descriptions

Relay Contacts

Input LEDs:

The LED that is above the terminal wiring input will light when that terminal input gets activated.

Terminal #5 Note:
Exceeding 250 mA of power from this terminal may cause the circuit board transformer to overheat, causing intermittent problems.

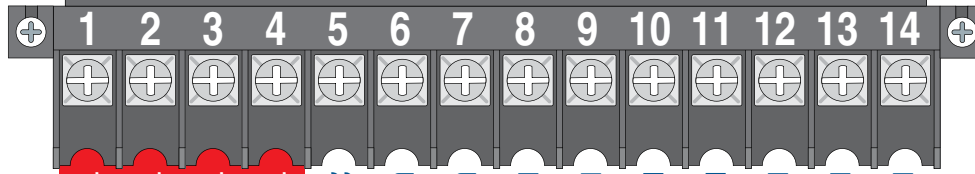

Function is dependent on the setting of programming SW 1, switch 6. When switch 6 is **OFF**, this input will cause the operator to rotate the arm to the up position. If the arm is in the down cycle, this input will reverse the arm to the up position. If this terminal has a constant input, the arm will remain in the up position regardless of any down input or timer command to rotate down. When switch 6 is **ON**, this input will cause the operator to rotate the arm to the up position when it is down, and will cause the operator to rotate the arm to the down position when it is up. If the auto timer is turned ON (Not recommended if switch 6 is ON), this input will override the timer and rotate the arm to the down position. If the arm is in the down cycle, this input will reverse the arm to the up position.

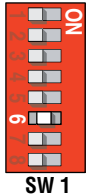

Function is dependent on the setting of programming SW 1, switch 8. When switch 8 is **ON**, the function of this input is identical to terminal 6. When switch 8 is **OFF**, this terminal becomes the logic output of the up loop detector.

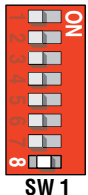

Function is dependent on the setting of programming SW 1, switches 1 and 4. With switch 1 **OFF** and switch 4 **ON**, activation and then deactivation of this input will rotate the arm to the down position, provided that the deactivation of the input happens while the arm is in the full up position. This input will override the auto timer if it is turned **ON**. If the arm is in the down position, traveling in the down cycle, or traveling in the up cycle, activation and deactivation of this input has no effect on the arm. With switches 1 and 4 are **ON**, activation and then deactivation of this input will rotate the arm to the down position after it reaches the full up position regardless of when the deactivation of the input occurred. When switch 4 is **OFF**, this input is identical to the reverse input, terminal 9.

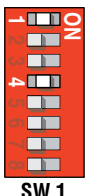

Function is dependent on the setting of programming SW 1, switch 5. When switch 5 is **OFF**, activation of the down loop will activate the relay. When switch 5 is **ON**, activation of the UP loop will activate the relay.



Relay contacts can be set for Normally Open (NO) or Normally Closed (NC) operation. Contact rating is **24V AC or DC @ 1 amp max.**

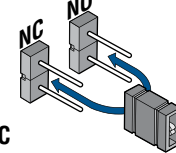

This input is used when sequencing the 1603 with a slide or swing gate operator in **PAMS** applications. This input is only active after a **MOMENTARY UP** input is received. Activation of this input will rotate the arm to the up position or reverse an arm in the down cycle to the up position.

This input is used when sequencing the 1603 with a slide or swing gate operator in **PAMS** applications. Activation of this input will rotate the arm to the up position one time, and activates the enable up input.

When the arm is in the down position, activation of this input has no effect. When the arm is in the up position, activation of this input will prevent the arm from rotating to the down position. If the arm is in the down cycle, activation of this input will reverse the arm to the up position.

See page 7 for terminal wiring.

1603 SPECIFICATIONS

Use this manual for the Model 1603 operators with circuit board 1601-010 Rev AK or higher ONLY.

Type of wiring to be used on ALL external devices:

- A) Type CL2, CL2P, CL2R, or CL2X.
- B) Other cable with equivalent or better electrical, mechanical, and flammability ratings.

Class of Operation

Model 1603 - UL 325 Class II, III, IV – ETL Listed

Type of Gate

Single Traffic Lane Vehicular Barrier Gate Only

Arm Types

Aluminum – Straight or Folding Arm

Max Arm Length

14 Ft.

Max Spike Length

9 Ft. (Three 3-ft spike sections)

Gate Cycles

High Cycle

Speed

90° in approximately 2.5 seconds

Pedestrian Protection

Inherent entrapment sensing system (Type A)

Provision for connection of a non-contact sensor (Type B1) and/or contact sensor (Type B2)

Model #	Convenience Open	Horsepower - Volts	Amp
1603-380	No	1/2 HP - 115 VAC	5.7
1603-381	Yes	1/2 HP - 115 VAC	5.7

Note: 208/230/460/575 VAC input voltage can be connected to the operator by installing an “Optional” High Voltage Kit (P/N 2600-266).

Drawings not to scale

1603 Housing

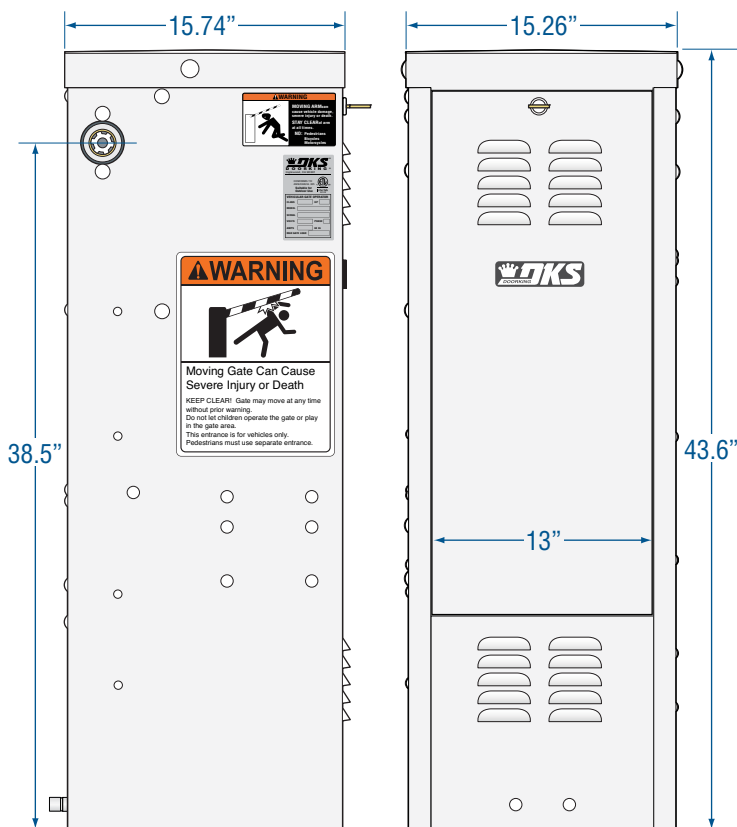

1603 Aluminum Arms

Folding arm assembly can be installed for low headroom application.

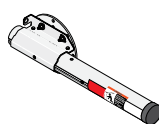

Round Aluminum Arm (No LEDs)

- Choose ↓ 14 Ft 1-Piece Aluminum Arm Only P/N 1601-516
 - Choose ↓ 14 Ft 2-Piece Aluminum Arm Only P/N 1601-524
- Arm Hardware Kit (Required) P/N 1601-242

Round Aluminum FOLDING Arm (No LEDs)

Aluminum FOLDING Arm Kit (With Arm) P/N 1601-610

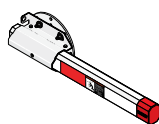

Octagon Arm (No reversing edge or LEDs)

- Choose ↓ 14 Ft 1-Piece Octagon Arm Only P/N 1601-555
 - Choose ↓ 14 Ft 2-Piece Octagon Arm Only P/N 1601-567
- Arm Hardware Kit (Required) P/N 1601-242
- Rubber Bumper P/N 8080-089

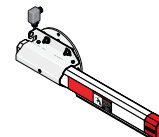

Octagon Reversing Edge Arm (No LEDs)

- Choose ↓ 14 Ft 1-Piece Octagon Arm Only P/N 1601-555
 - Choose ↓ 14 Ft 2-Piece Octagon Arm Only P/N 1601-567
- Octagon Arm Hardware Kit (Required) P/N 1601-235
- Reversing Edge (Required) P/N 8080-080

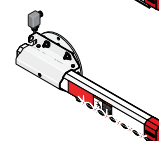

Octagon Reversing Edge/Red-Green LED Arm

- Choose ↓ 14 Ft 1-Piece Octagon Arm Only P/N 1601-555
 - Choose ↓ 14 Ft 2-Piece Octagon Arm Only P/N 1601-567
- Octagon Arm Hardware Kit (Required) P/N 1601-235
- Reverse Edge + Red/Green LED (Required) P/N 8080-096

1603 Auto Spike System

Up to 3 spike sections can connect together.

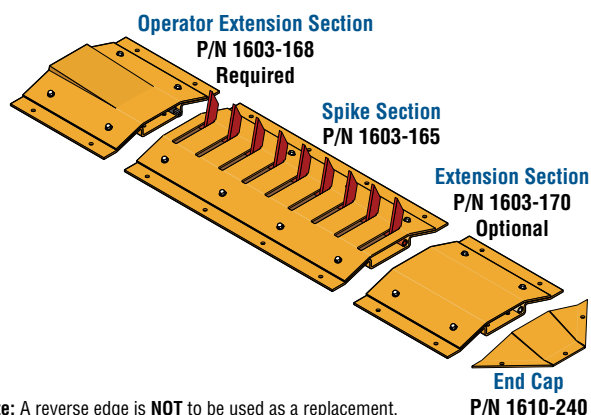

Contact Sensor Note: A reverse edge is **NOT** to be used as a replacement, or in lieu of, in-ground loops or non-contact sensor (photocell) that protect vehicles passing underneath the barrier arm. A **moving** vehicle coming in contact with a downward moving barrier arm **WILL** result in **damage to the vehicle** and the barrier arm/reversing edge if **NOT** using in-ground loops or non-contact sensor (Photocell).

DoorKing, Inc. reserves the right to make changes in the products described in this manual without notice and without obligation of DoorKing, Inc. to notify any persons of any such revisions or changes. Additionally, DoorKing, Inc. makes no representations or warranties with respect to this manual. This manual is copyrighted, all rights reserved. No portion of this manual may be copied, reproduced, translated, or reduced to any electronic medium without prior written consent from DoorKing, Inc.

TABLE OF CONTENTS

IMPORTANT SAFETY INFORMATION	Safety-1-3
QUICK GUIDE - TERMINAL DESCRIPTIONS	Quick Guide-1
SPECIFICATIONS FOR 1603	Previous Page
SECTION 1 - INSTALLATION OF OPERATOR	2
1.1 Operator Positioning and Conduit Requirements	2
1.2 Concrete Pad Requirements	3
1.3 Mount Operator	3
1.4 Dual Operator Installation (Primary/Secondary)	4
SECTION 2 - WIRING	5
2.1 High Voltage Wire Runs	5
2.2 High Voltage Terminal Connections	5
2.3 Main Terminal Description	6
2.4 Control Wiring	7
SECTION 3 - INSTALLATION OF AUTO SPIKE SYSTEM	8
3.1 Connect Sections Together on Concrete Pad	8
3.2 Test Spikes when Operator Positioned on LEFT side	9
3.3 Test Spikes when Operator Positioned on RIGHT side	10
3.4 Secure EACH Section to Concrete	11
SECTION 4 - LOOP DETECTOR LANE SETUPS	12
4.1 Entry Lane Only	12
4.2 Exit Lane Only	13
4.3 2-Way Traffic Lane	14
4.4 Ticket Spitter Entry Lane	15
4.5 Operator Timer ON Entry Lane (No Down Loop)	16
SECTION 5 - ARM INSTALLATION	17
5.1 Mounting Hub	17
5.2 Mounting Aluminum Arm	17
SECTION 6 - ADJUSTMENTS	18
6.1 1601 Circuit Board Description and Adjustments	18
6.2 DIP-Switch SW 1 and SW 2 Settings	19-21
6.3 Magnetic Limit Adjustment	22
6.4 Reverse Sensor Adjustment	22
6.5 Manual Operation of Arm and Spikes	23
SECTION 7 - OPTIONAL CONVENIENCE OPEN SYSTEM	24
7.1 Circuit Board Settings and Descriptions	24
7.2 DC System Wire Schematic	25
SECTION 8 - OPTIONAL ACCESSORIES INSTALLATION	26
8.1 Contact Sensor Installation (Reversing Edge)	26
8.2 Additional "Optional" Accessories	27-28
SECTION 9 - TECHNICAL INSTRUCTIONS	29
9.1 Maintenance Schedule	29
9.2 Diagnostics Check	30
9.3 Troubleshooting	30-31
9.4 Accessories Parts List	32
Operator Wiring Schematics	33-34

SECTION 1 - INSTALLATION OF OPERATOR

Prior to beginning the installation of the barrier gate operator, we suggest that you become familiar with the instructions, illustrations, and wiring guide-lines in this manual. This will help insure that your installation is performed in an efficient and professional manner.

The proper installation of the vehicular barrier gate operator is an extremely important and integral part of the overall access control system. Check all local building ordinances and building codes prior to installing this operator. Be sure your installation is in compliance with local codes.

1.1 Operator Positioning and Conduit Requirements

Operator Mounted on LEFT Side of Traffic Lane Preferred (Factory Set)

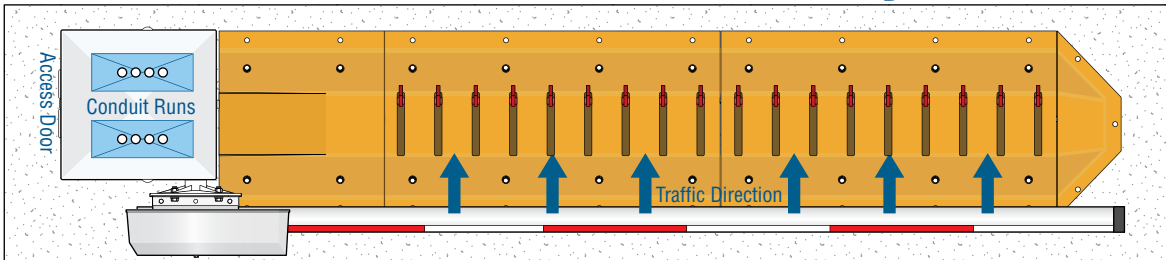

Operator Mounted on RIGHT Side of Traffic Lane

DO NOT install operator or spikes on asphalt.

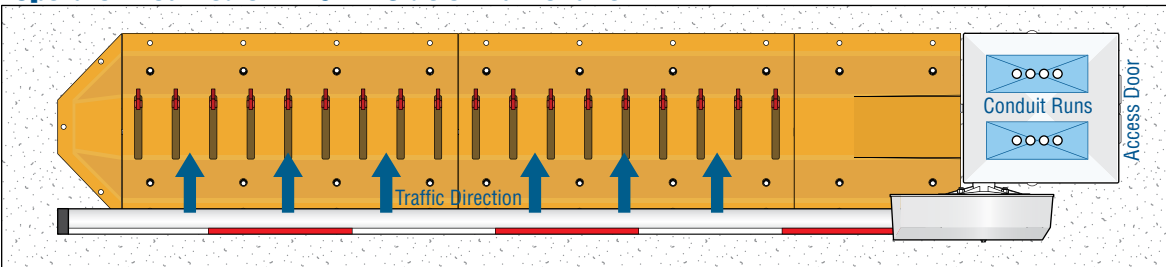

The spike's drive chain **MUST** be **reversed** so spikes rotate in correct direction when operator is on **RIGHT** side, see section 3.3.

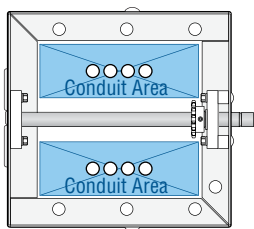

Inside Operator

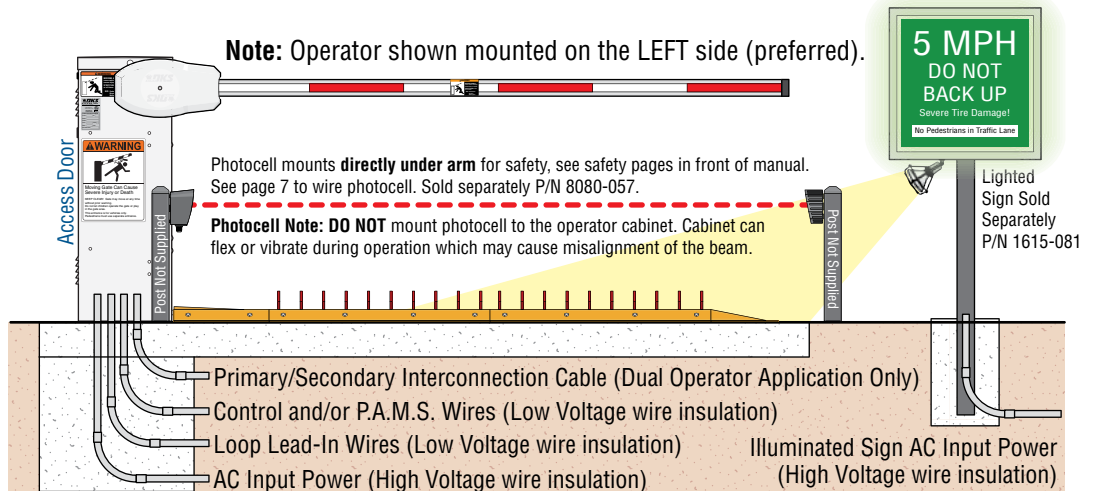

- The conduit requirements are for a typical barrier gate operator installation. **The conduit requirements for your application may vary from this depending on your specific needs.**
- Use only sweeps for conduit bends. Do not use 90° connectors as this will make wire pulls very difficult and can cause damage to wire insulation.
- We suggest that minimum 3/4-inch conduit be used.
- **Never** run low voltage rated wire insulation in the same conduit as high voltage rated wire insulation.
- Be sure that all conduits are installed in accordance with local codes.

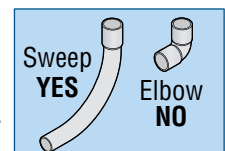

1.2 Concrete Pad Requirements

The operator and auto spike system must **ONLY** be installed on a **concrete pad** with a minimum 6 inch depth. The concrete pad must be **FLAT** and **LEVEL** (Check local building codes for restrictions). Reinforced concrete recommended.

Note: Operator shown mounted on the **LEFT** side of traffic lane (preferred).

Note: Operator extension section **REQUIRED** to connect to operator.

It is recommended that the "Spike" sections not exceed **9 feet** (Three 3-Ft spike sections) for proper operation.

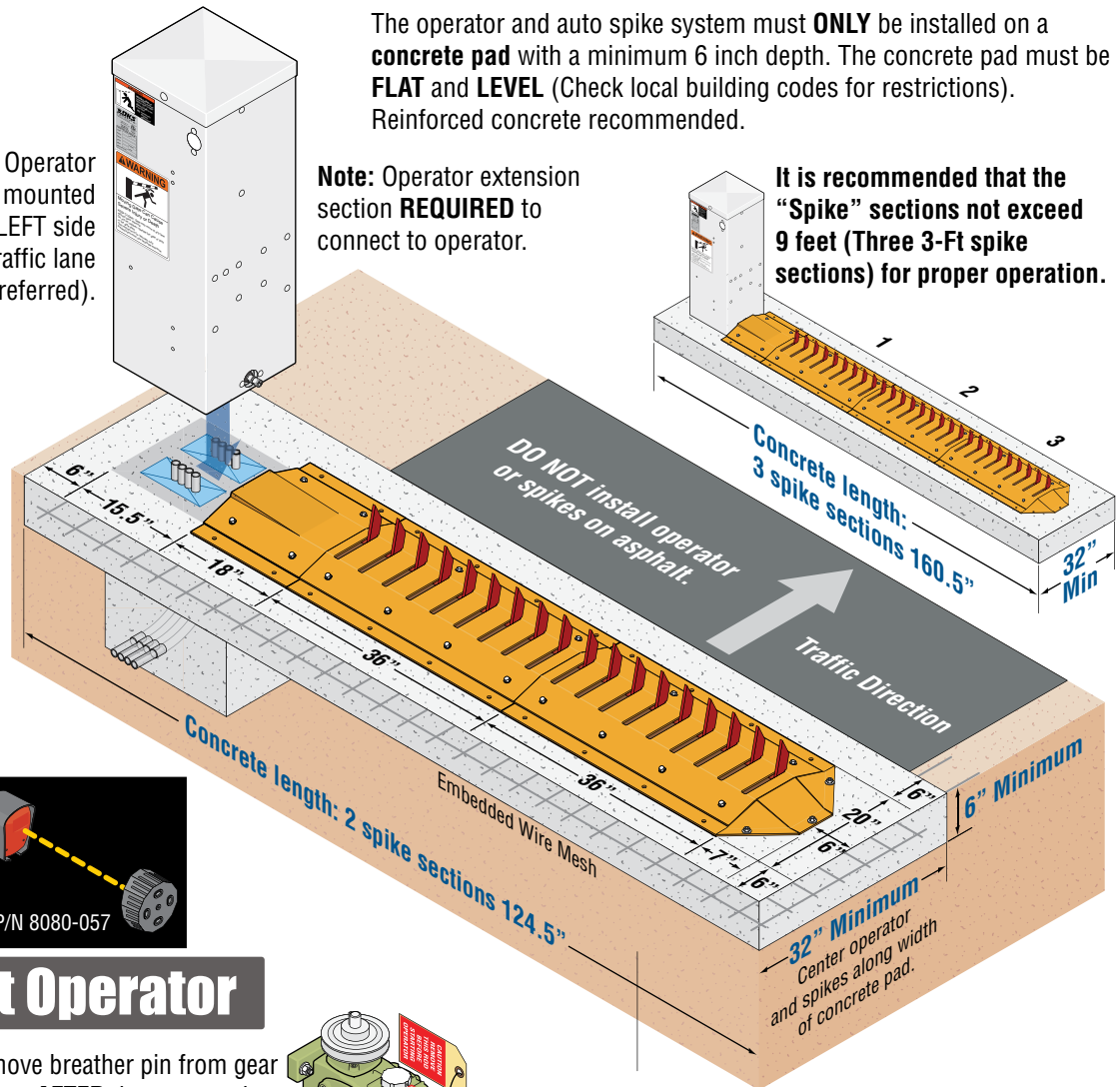

IMPORTANT: A barrier gate operator installed **WITHOUT** any external safety sensors **CANNOT** sense a person under the raised arm and can strike them while the arm is lowering. DoorKing recommends installing an external photo sensor directly under the arm. See safety pages in front of this manual for more information.

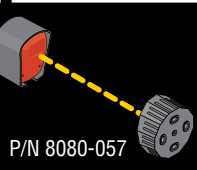

1.3 Mount Operator

Remove breather pin from gear reducer **AFTER** the operator has been secured in place.

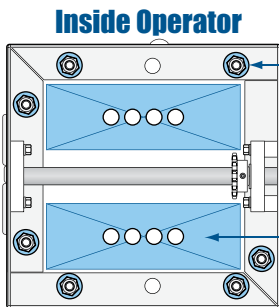
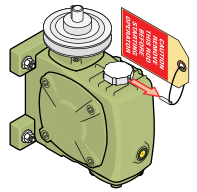

Secure the operator to the concrete pad with the mounting flange using 1/2" x 3" minimum sleeve anchors (not supplied).

Approximate position of conduit runs.

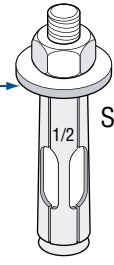

Sleeve Anchor 1/2

Sections **MUST** lay flat and level to operate properly!

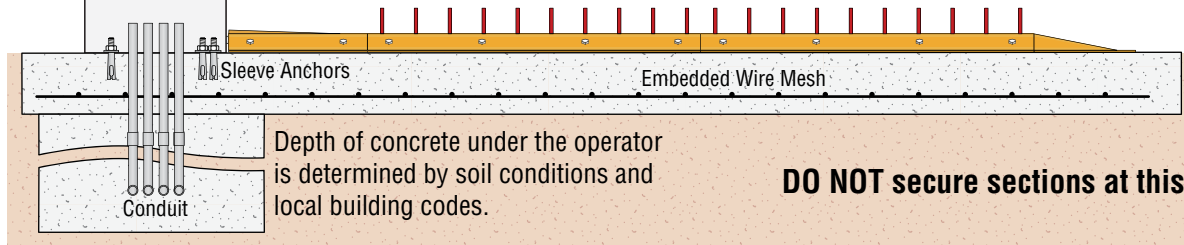

Depth of concrete under the operator is determined by soil conditions and local building codes.

DO NOT secure sections at this time.

1.4 Dual Operator Installation (Primary/Secondary)

For use in areas needing **more** than **three** 3-Ft spike sections (9 ft. of spikes) in a traffic lane. Up to **six** 3-Ft spike sections (18 ft. of spikes) can be used with dual operators.

Install dual operators the **same** as installing two single operators except for:

- There are no end cap sections used for the spikes.
- **RIGHT** side operator spike's drive chain will need to be **reversed**, see section 3.3.
- Operators need to be wired together with an interconnection cable (Sold separately).
- Each operator requires AC power.
- Both operator's DIP-switches (SW 1, SW 2) must be set the same.
- Connect all loop detectors and access control devices to the **PRIMARY** operator **ONLY**.

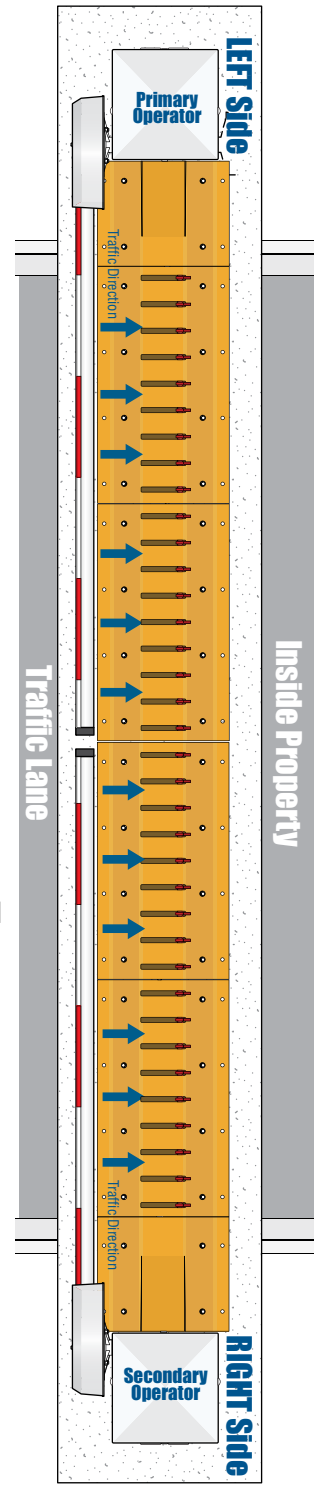
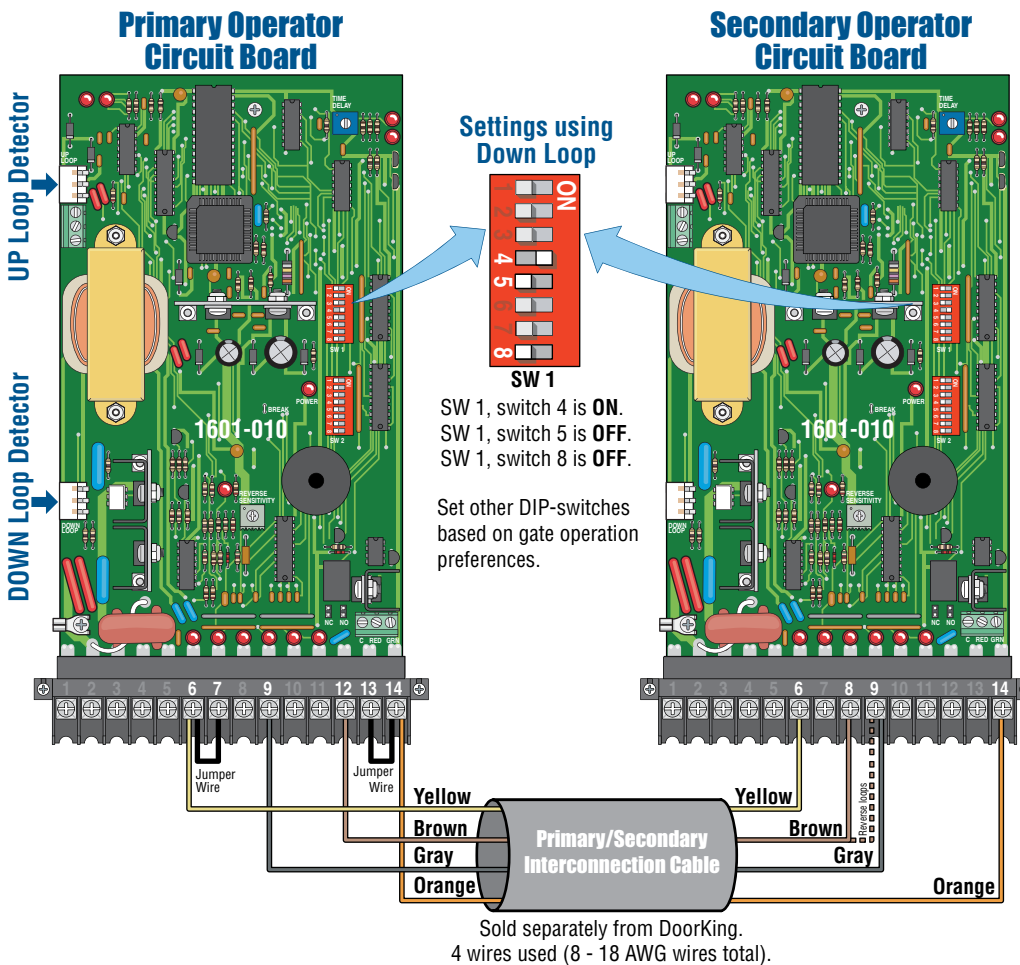

When using Reverse Loops:

DIP-Switch settings: SW 1, switch 4 is OFF. SW 1, switch 5 is OFF. SW 1, switch 8 is OFF. Set other DIP-switches based on gate operation preferences. See page 16 for reverse loop wiring.

Interconnection cable: The **BROWN** wire must be connected to **SECONDARY TERMINAL #9** along with the **GRAY** wire. All other terminal wire connections are the same as shown above.

IMPORTANT: The barrier gate operators installed **WITHOUT** any external safety sensors **CANNOT** sense a person under the raised arms and can strike them while the arms are lowering. DoorKing recommends installing an external photo sensor directly under the arm. See safety pages in front of this manual for more information.

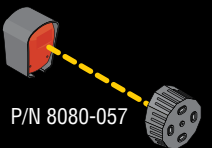

P/N 8080-057

Illustration shows four 3-ft spike sections (12 ft. of spikes). Each operator controls two 3-ft spike sections.

SECTION 2 - WIRING

Before attempting to connect any wiring to the operator, be sure that the circuit breaker in the electrical panel is in the OFF position. Permanent wiring must be installed to the operator as required by local electrical codes. It is recommended that a licensed electrical contractor perform this work.

Since building codes vary from city to city, we highly recommend that you check with your local building department prior to installing any permanent wiring to be sure that all wiring to the operator (both high and low voltage) complies with local code requirements.

THIS GATE OPERATOR MUST BE PROPERLY GROUNDED!!

2.1 High Voltage Wire Runs

The distance shown in the chart is measured in “Feet” from the operator to the power source. If power wiring is greater than the maximum distance shown, it is recommended that a service feeder be installed. When large gauge wire is used, a separate junction box must be installed for the operator connection. The wire table is based on stranded copper wire. Wire run calculations are based on the NEC recommended maximum 3% voltage drop on the power line, plus an additional 10% reduction in distance to allow for other losses in the system.

This table illustrates the high voltage AC power wire size and distance limitations.

Model Type	Voltage Required	Amps Required	Wire Size / Max Distance in Feet			
			12 AWG	10 AWG	8 AWG	6 AWG
1603 1/2 HP	115	5.7	170	275	460	690

Never run low voltage rated wire insulation in the same conduit as high voltage rated wire insulation.

“Optional” Heater Installation Note: When installing a heater, refer to the “high voltage AC power wire size and distance limitations” table on the instruction sheet with the specific heater kits (115, 208/230, 460 VAC) for AC power wire run limitations.

“Optional” High Voltage Kit Installation Note: When installing the high voltage kit for 208/230/460/575 VAC input power, refer to the “high voltage AC power wire size and distance limitations” table on the instruction sheet with the high voltage kit (P/N 2600-266) for AC power wire run limitations.

2.2 High Voltage Terminal Connections

- Route incoming high voltage power in its **OWN** conduit.
- Be sure wiring is installed in accordance with local codes. Be sure to color code all wiring.
- It is recommended that a surge suppressor be installed on the high voltage power lines to help protect the operator and circuit board from surges and power fluctuations.
- Dual operators (Primary/Secondary) require AC power to each operator.

 **Keep wire clear of all moving parts.**

DO NOT power up and cycle the operator until the “DIP-Switches” have been set for the 1603 model (See pages 18 and 19). The operator will not function properly unless the switches have been correctly set.

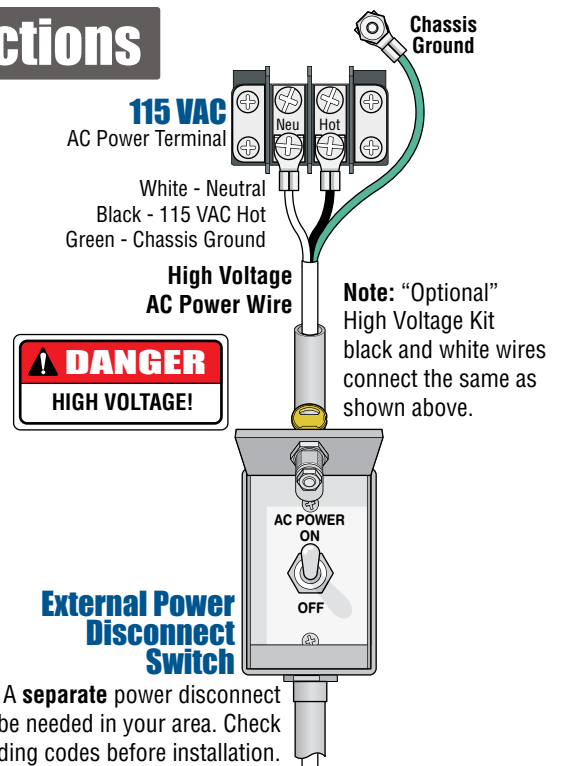

2.3 Main Terminal Description

Relay Contacts

Input LEDs:

The LED that is above the terminal wiring input will light when that terminal input gets activated.

Terminal #5 Note:
Exceeding 250 mA of power from this terminal may cause the circuit board transformer to overheat, causing intermittent problems.

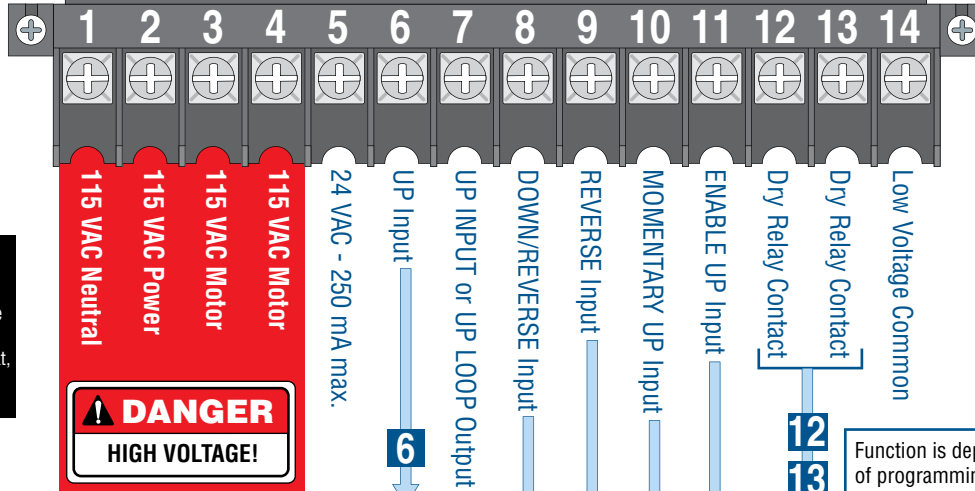
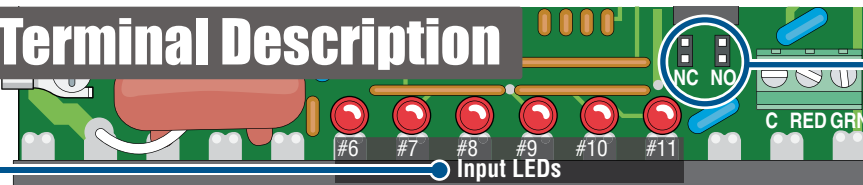

Function is dependent on the setting of programming SW 1, switch 6. When switch 6 is **OFF**, this input will cause the operator to rotate the arm to the up position. If the arm is in the down cycle, this input will reverse the arm to the up position. If this terminal has a constant input, the arm will remain in the up position regardless of any down input or timer command to rotate down. When switch 6 is **ON**, this input will cause the operator to rotate the arm to the up position when it is down, and will cause the operator to rotate the arm to the down position when it is up. If the auto timer is turned ON (Not recommended if switch 6 is ON), this input will override the timer and rotate the arm to the down position. If the arm is in the down cycle, this input will reverse the arm to the up position.

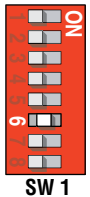

Function is dependent on the setting of programming SW 1, switch 5. When switch 5 is **OFF**, activation of the down loop will activate the relay. When switch 5 is **ON**, activation of the UP loop will activate the relay.

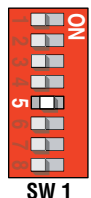

Relay contacts can be set for Normally Open (NO) or Normally Closed (NC) operation. Contact rating is **24V AC or DC @ 1 amp max.**

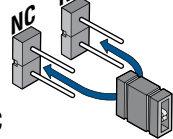

Function is dependent on the setting of programming SW 1, switch 8. When switch 8 is **ON**, the function of this input is identical to terminal 6. When switch 8 is **OFF**, this terminal becomes the logic output of the up loop detector.

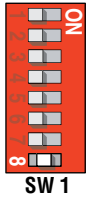

This input is used when sequencing the 1603 with a slide or swing gate operator in **PAMS** applications. This input is only active after a **MOMENTARY UP** input is received. Activation of this input will rotate the arm to the up position or reverse an arm in the down cycle to the up position.

Function is dependent on the setting of programming SW 1, switches 1 and 4. With switch 1 **OFF** and switch 4 **ON**, activation and then deactivation of this input will rotate the arm to the down position, provided that the deactivation of the input happens while the arm is in the full up position. This input will override the auto timer if it is turned **ON**. If the arm is in the down position, traveling in the down cycle, or traveling in the up cycle, activation and deactivation of this input has no effect on the arm. With switches 1 and 4 are **ON**, activation and then deactivation of this input will rotate the arm to the down position after it reaches the full up position regardless of when the deactivation of the input occurred. When switch 4 is **OFF**, this input is identical to the reverse input, terminal 9.

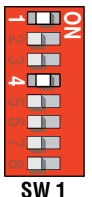

This input is used when sequencing the 1603 with a slide or swing gate operator in **PAMS** applications. Activation of this input will rotate the arm to the up position one time, and activates the enable up input.

When the arm is in the down position, activation of this input has no effect. When the arm is in the up position, activation of this input will prevent the arm from rotating to the down position. If the arm is in the down cycle, activation of this input will reverse the arm to the up position.

2.4 Control Wiring for Single/Primary Operator

DoorKing Access Control System (Model 1833, 1835, 1837 or 1838) tracker system can be connected. This system can keep track of gate operator cycle count, shorted inputs, loop detector problems, any forced entry attempts, if the gate has struck anything during the open or close cycle, power interruptions, etc. For more detailed information refer to the Tracker Installation and Wiring Manual, DoorKing P/N 2358-010.

Terminal 6 required only if the tracker board will **activate** the gate operator. Refer to the manual 2358-065 for detailed information.

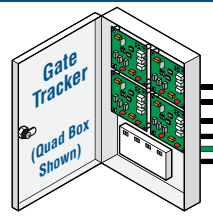

Type of wiring to be used on ALL external devices:
A) Type CL2, CL2P, CL2R, or CL2X.
B) Other cable with equivalent or better electrical, mechanical, and flammability ratings.

115 VAC Convenience Outlets

Power safety and opening devices that require 115 VAC power.

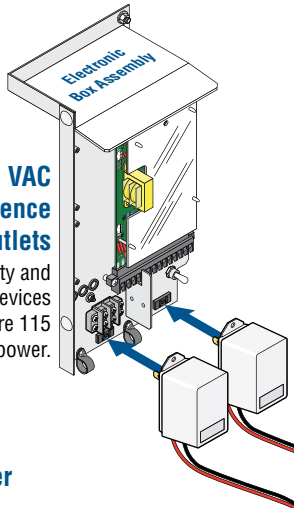

Antenna mounted outside operator housing.

Coax Antenna Kit P/N 1514-073

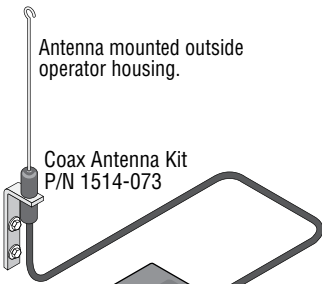

3-Wire Radio Receiver

3. 24 Volt

2. Relay

1. Com

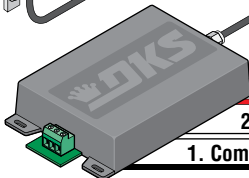

Up-Inputs

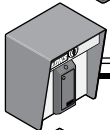

Down-Inputs

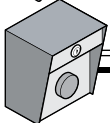

Terminal #5 Note: Exceeding 250 mA of power from this terminal may cause the circuit board transformer to overheat, causing intermittent problems.

WARNING

User **MUST** make sure gate area **IS CLEAR** before manually operating gate arm.

Manual Gate Control Toggle

P/N 1200-017



Up toggle position: User toggles switch up to hold gate open.
Center toggle position: Is neutral for normal operation.

ROUND Aluminum Arm Contact Sensor ONLY

See page 26

2-Wire 6ft Reversing Edge P/N 8080-071

4-Wire 6ft Reversing Edge P/N 8080-091

Non-Contact Sensor (Always Reverses)

21" Typical Beam Height.
 27.5" Max. Beam Height.

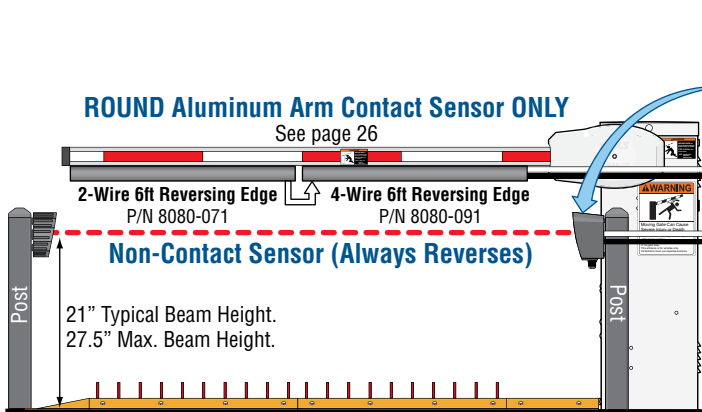

24 Volt
 DoorKing P/N-8080-057 Photocell power supply (Sold separately)

Contact and Non-Contact Sensors Note: Helps minimize the potential of the arm lowering on vehicular or other traffic that loops cannot sense.

Non-Contact Sensor Installation Note: **DO NOT** mount photocell to the operator cabinet. Cabinet can flex or vibrate during operation which may cause misalignment of the beam.

SECTION 3 - AUTO SPIKE SYSTEM INSTALLATION

The operator and auto spike system must be installed on a flat and level concrete pad with a minimum 6 inch depth (Check local building codes for restrictions). Reinforced concrete recommended. **It is recommended that the "Spike" sections not exceed 9 feet (Three 3-Ft spike sections) for proper operation.**

3.1 Connect Sections Together on Concrete Pad

Snap all sections together using socket connectors with spikes aligned in UP position.
DO NOT anchor them to the concrete at this time.

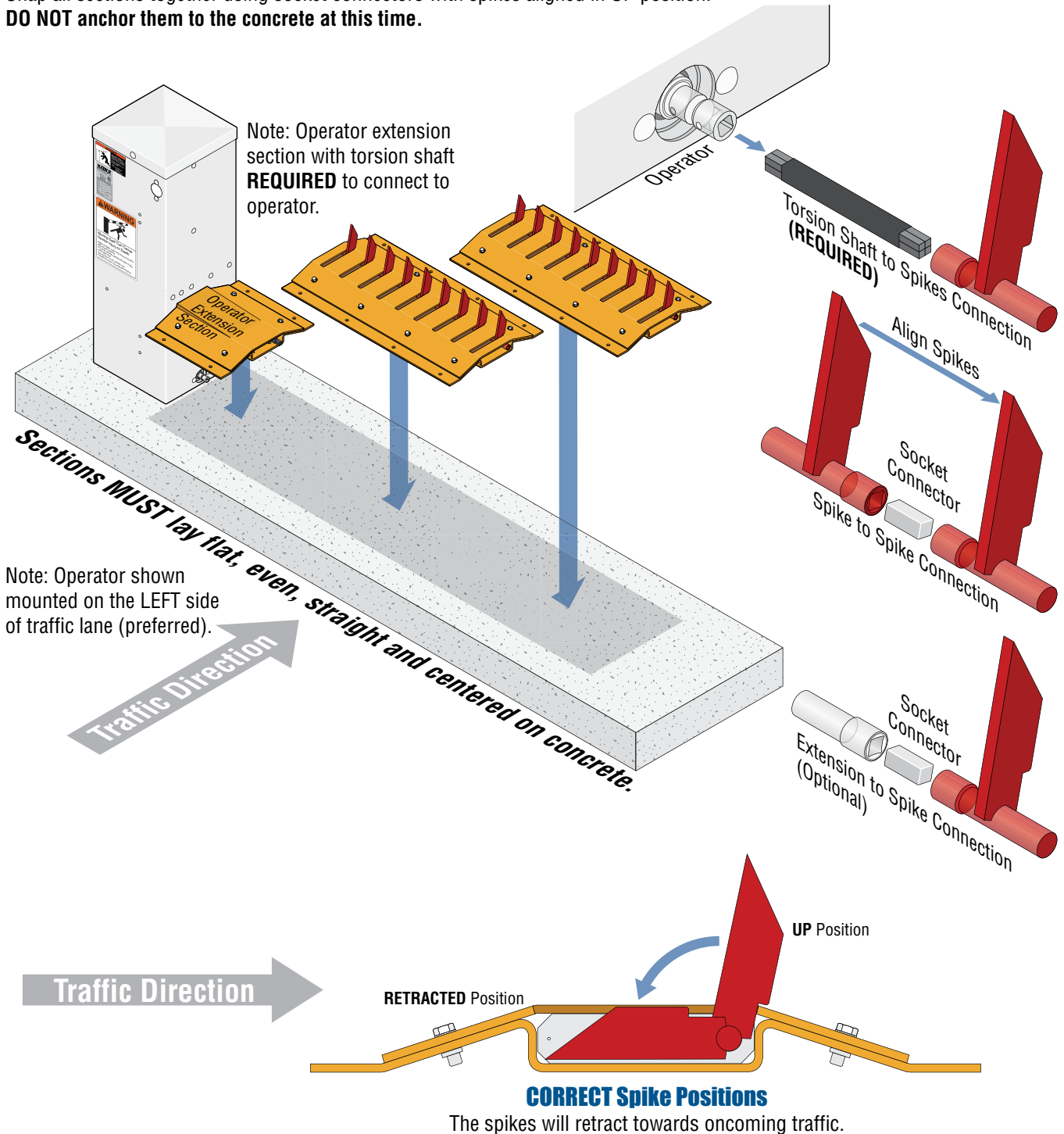

3.2 Test Spikes when Operator positioned on LEFT side

Note: If operator is positioned on **RIGHT** side, see next page.

DO NOT anchor the sections to the concrete until the spikes have been tested and they operate smoothly. If spikes are not in the correct **UP** and **RETRACTED** positions during operation as shown on previous page, some adjustment will be required (See below).

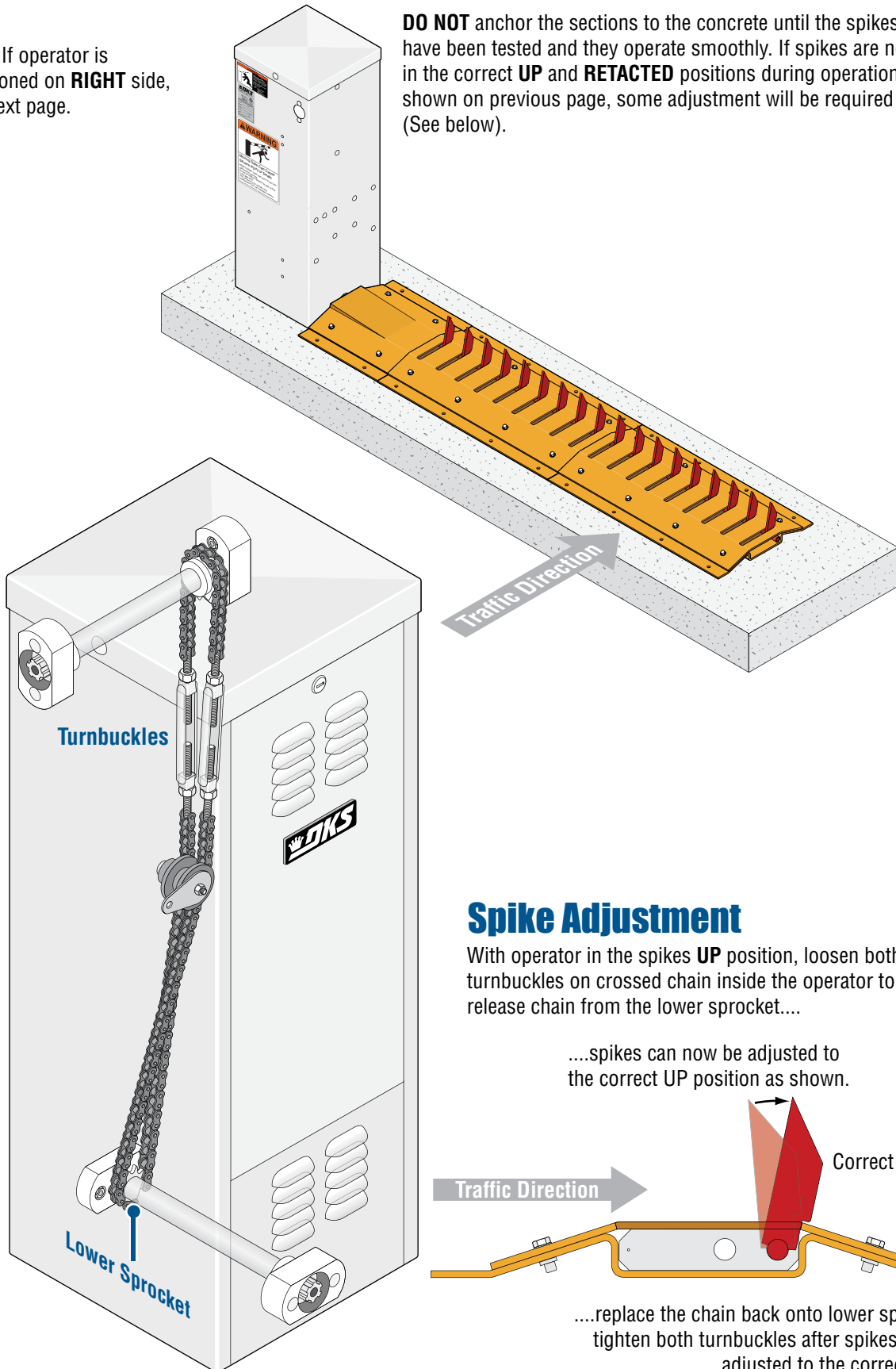

Spike Adjustment

With operator in the spikes **UP** position, loosen both turnbuckles on crossed chain inside the operator to release chain from the lower sprocket....

....spikes can now be adjusted to the correct UP position as shown.

....replace the chain back onto lower sprocket and tighten both turnbuckles after spikes have been adjusted to the correct position.

3.3 Test Spikes when Operator positioned on RIGHT side

When operator is mounted on the **RIGHT** side as shown, the chain **MUST** be **reversed** (See below).

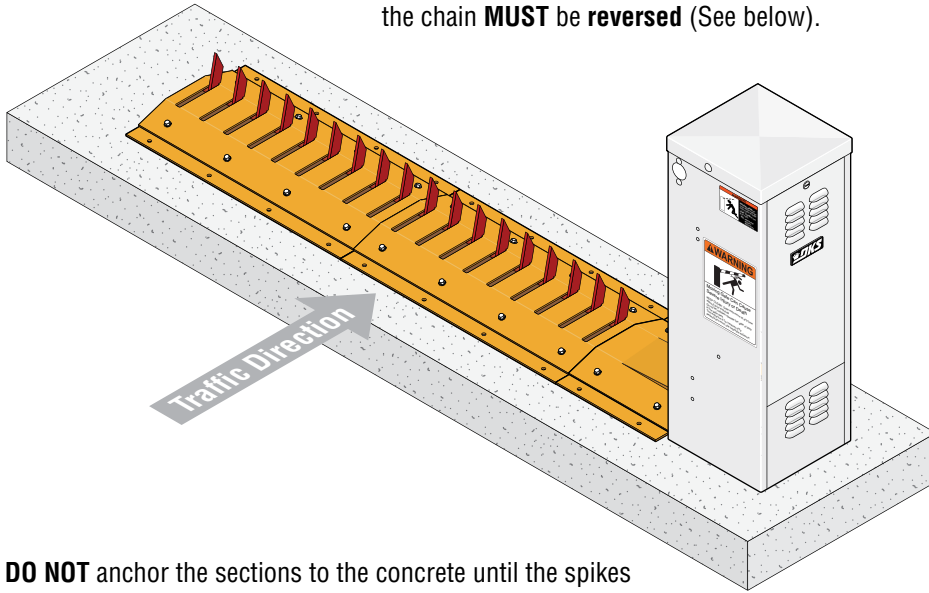

DO NOT anchor the sections to the concrete until the spikes have been tested and they operate smoothly. If spikes are not in the correct **UP** and **RETRACTED** positions during operation, some adjustment will be required (See below).

Reverse Chain

Use the master links to disconnect the spike's drive chain and reverse it so spikes will rotate in the correct direction. The spikes can also be adjusted to the correct position at this time (see below)

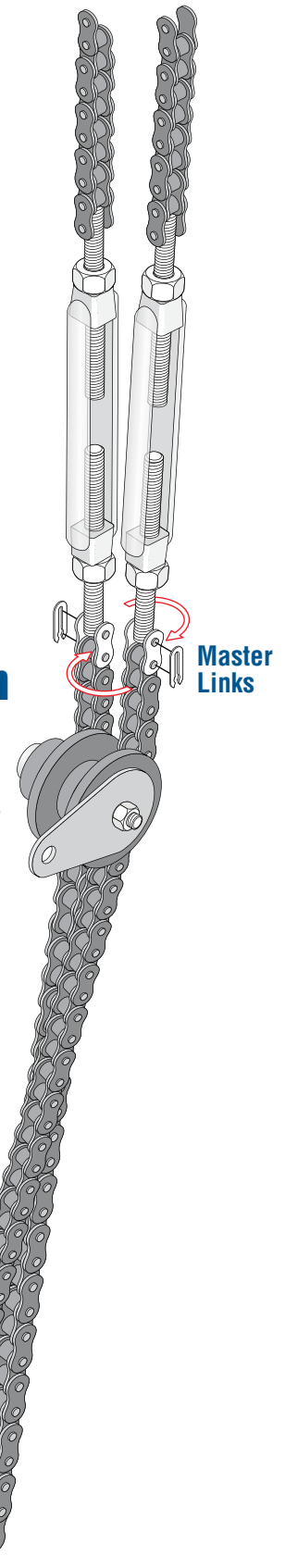

Spike Adjustment

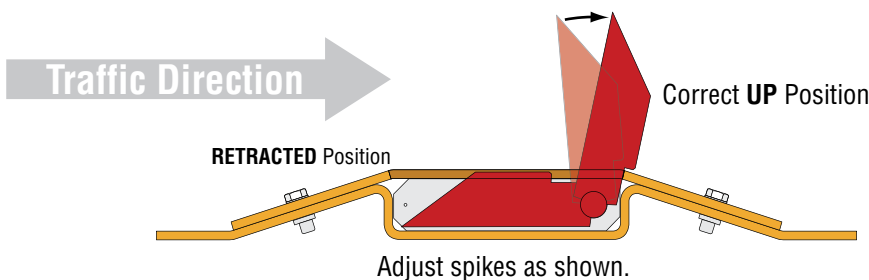

3.4 Secure EACH Section to Concrete

Extreme force is exerted on the sections every time a vehicle drives over them. It is important that they have enough anchors in them to keep them securely in place.

After you have tested the spikes and are satisfied with the way they perform, **without moving the sections**, secure **EACH** section in place with sleeve anchors (8 sleeve anchors are located inside the spike sections. The ramps will need to be unbolted to gain access to the mounting holes). After ALL sections have been secured to the concrete, mount the end cap in place.

Maintenance Tip: It is important to check the sections every so often to make sure all the sleeve anchors have not loosened up. The spikes will **NOT** function well with loose sleeve anchors.

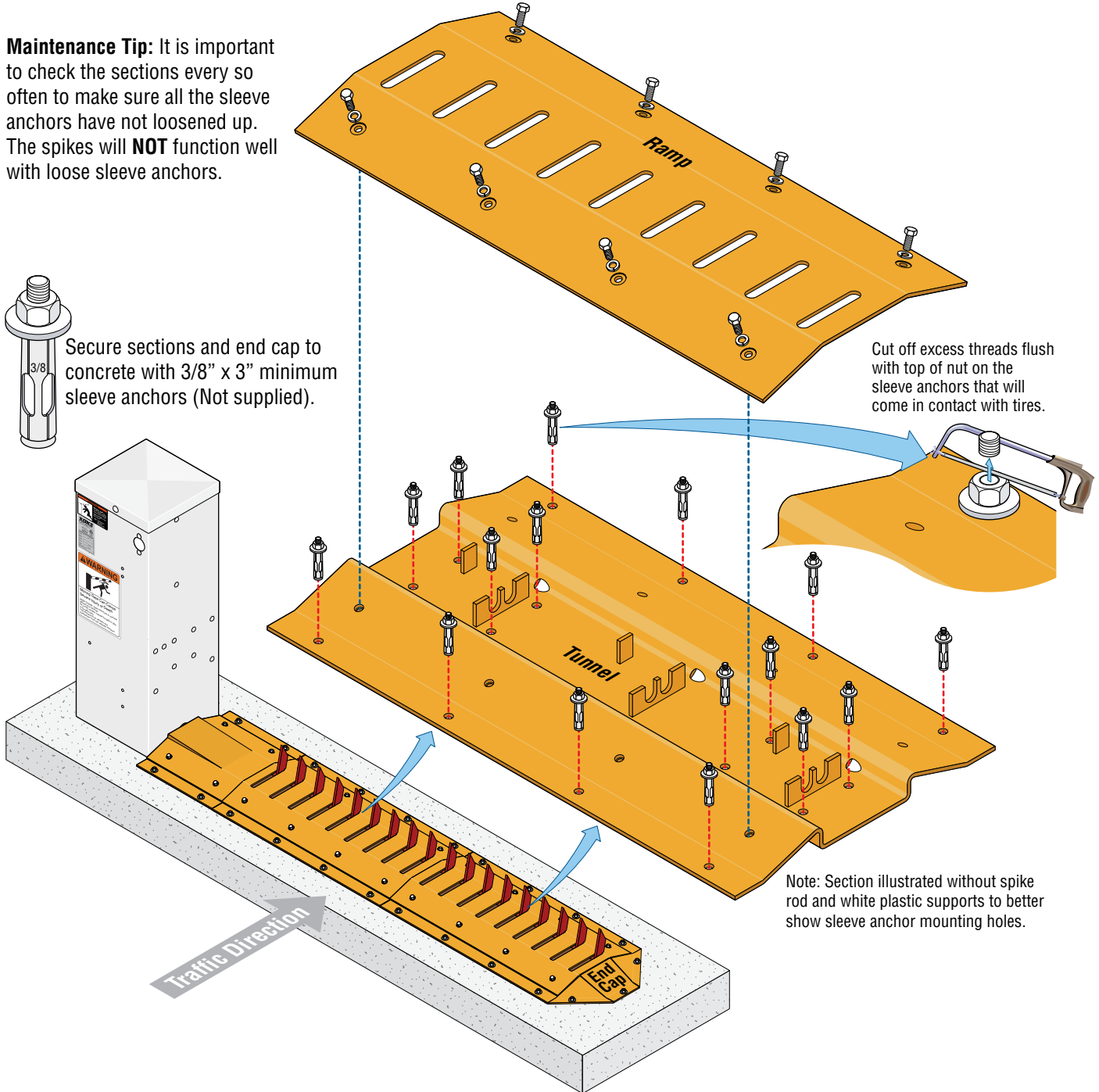

Cleaning the Spikes

The ramps will have to be unbolted and the tunnel will need to have the debris cleaned out every so often to keep the spikes in good working condition. The sleeve anchors mounted inside the tunnel will also need to be checked for looseness and repaired when necessary.

SECTION 4 - LOOP DETECTOR LANE SETUPS

Before attempting to connect any wiring to the operator, be sure that the circuit breaker in the electrical panel is in the OFF position. Permanent wiring must be installed to the operator as required by local electrical codes. It is recommended that a licensed electrical contractor perform this work.

Loop detector wiring shown is for DoorKing model 9409 Dual Channel and 9410 Single Channel plug-In loop detectors only. If using other loop detectors refer to the separate Loop Information Manual for installation instructions, loops/preformed loops and wiring diagrams. All inputs to the main terminal are NORMALLY OPEN.

4.1 Entry Lane Only

Type of wiring to be used on ALL external devices:
A) Type CL2, CL2P, CL2R, or CL2X.
B) Other cable with equivalent or better electrical, mechanical, and flammability ratings.

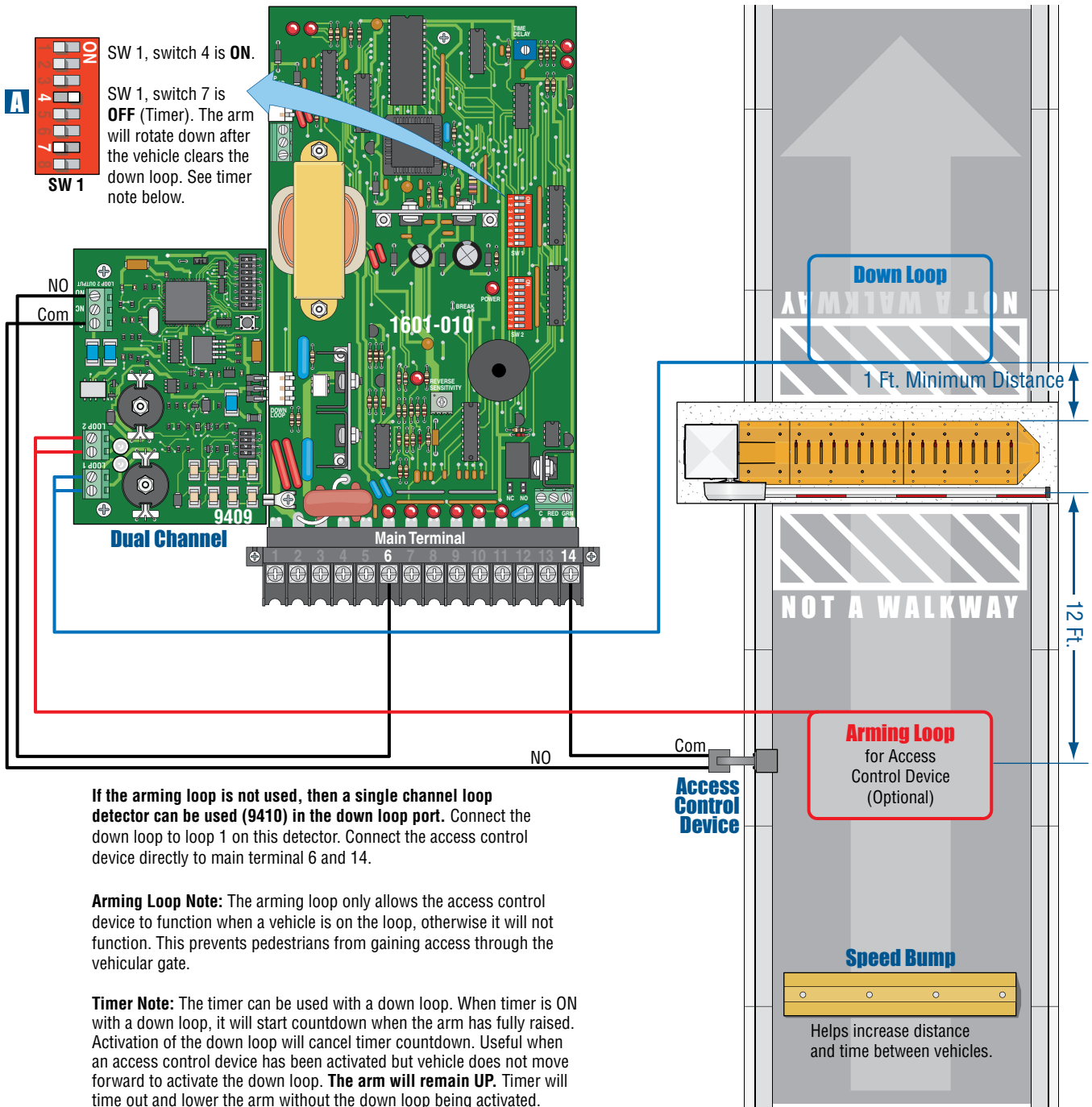

If the arming loop is not used, then a single channel loop detector can be used (9410) in the down loop port. Connect the down loop to loop 1 on this detector. Connect the access control device directly to main terminal 6 and 14.

Arming Loop Note: The arming loop only allows the access control device to function when a vehicle is on the loop, otherwise it will not function. This prevents pedestrians from gaining access through the vehicular gate.

Timer Note: The timer can be used with a down loop. When timer is ON with a down loop, it will start countdown when the arm has fully raised. Activation of the down loop will cancel timer countdown. Useful when an access control device has been activated but vehicle does not move forward to activate the down loop. **The arm will remain UP.** Timer will time out and lower the arm without the down loop being activated.

4.2 Exit Lane Only

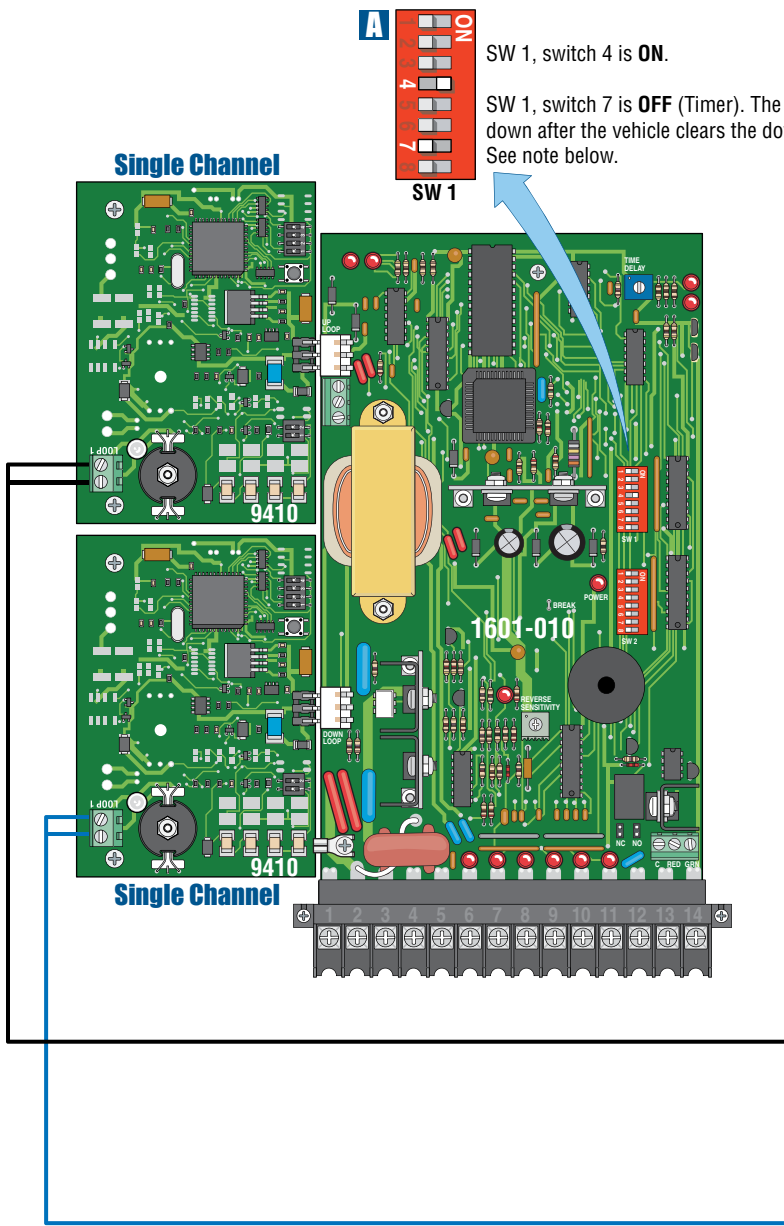

A SW 1, switch 4 is **ON**.
 SW 1, switch 7 is **OFF** (Timer). The arm will rotate down after the vehicle clears the down loop. See note below.

Type of wiring to be used on ALL external devices:
A) Type CL2, CL2P, CL2R, or CL2X.
B) Other cable with equivalent or better electrical, mechanical, and flammability ratings.

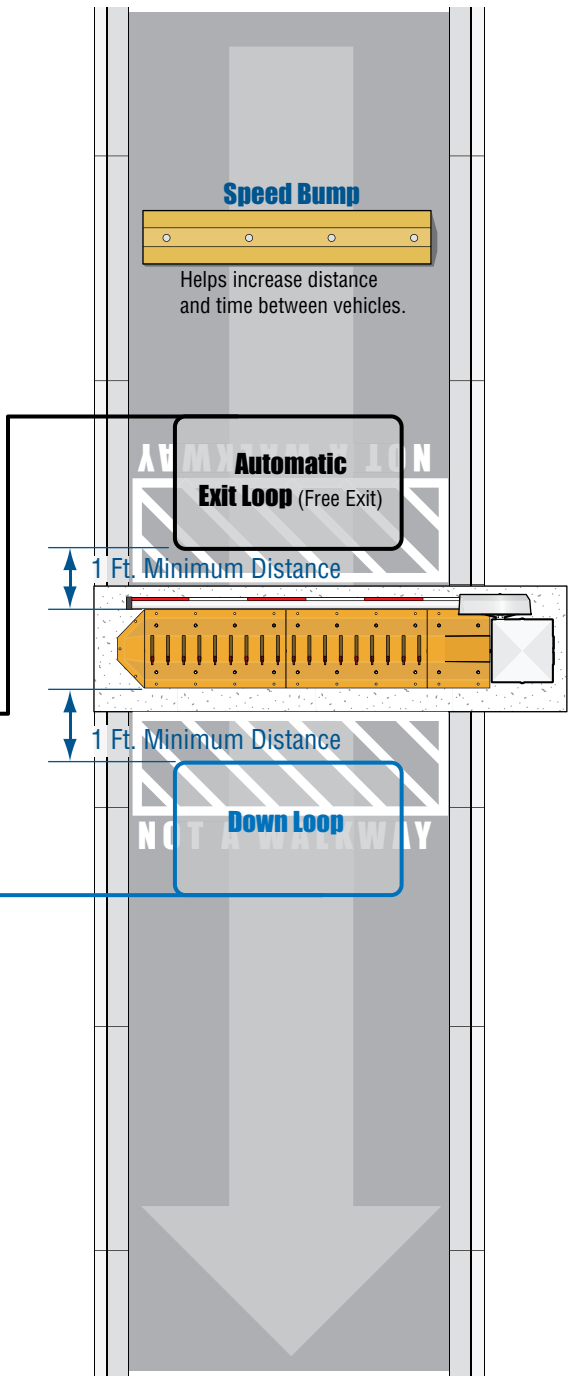

Note: The timer can be used with a down loop. When timer is ON with a down loop, it will start countdown when the arm has fully raised. Activation of the down loop will cancel timer countdown. Useful when the automatic exit loop has been activated but vehicle does not move forward to activate the down loop. **The arm will remain UP.** Timer will time out and lower the arm without the down loop being activated.

4.3 Two-Way Traffic Lane

When a vehicle enters, the down loop will be overridden by the automatic exit loop which will continue to hold the arm up. When the interior down loop has been cleared by the vehicle, the arm will lower.

When a vehicle exits, the automatic exit loop will raise arm and when the down loop is cleared, the arm will lower. The interior down loop is inoperative for exiting vehicles.

Type of wiring to be used on ALL external devices:
A) Type CL2, CL2P, CL2R, or CL2X.
B) Other cable with equivalent or better electrical, mechanical, and flammability ratings.

Single Channel

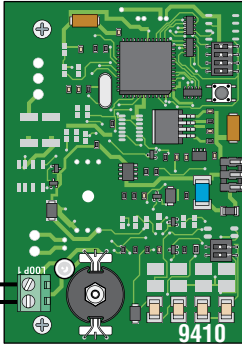

Dual Channel

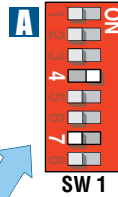
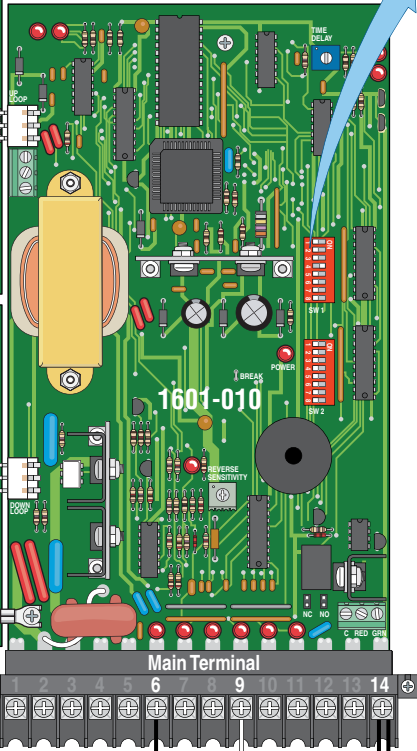
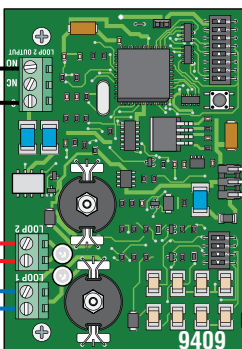

SW 1, switch 4 is ON.

SW 1, switch 7 is OFF (Timer). The arm will rotate down after the vehicle clears the down loops. See timer note below.

Down loops wired in series.

Non-Contact Sensor Note: DoorKing **highly recommends** installing a non-contact sensor (photocell) directly under the arm for safety.

If the arming loop is not used, then a Single Channel Loop Detector can be used (9410) in the down loop port. Connect the down loops to loop 1 on this detector. Connect the access control device directly to main terminal 6 and 14.

Arming Loop Note: The arming loop only allows the access control device to function when a vehicle is on the loop, otherwise it will not function. This prevents pedestrians from gaining access through the vehicular gate.

Timer Note: The timer can be used with down loops. When timer is ON with a down loop, it will start countdown when the arm has fully raised. Activation of the down loop will cancel timer countdown. Useful when the access control device or automatic exit loop has been activated but vehicle does not move forward to activate the down loop. **The arm will remain UP.** Timer will time out and lower the arm without the down loop being activated.

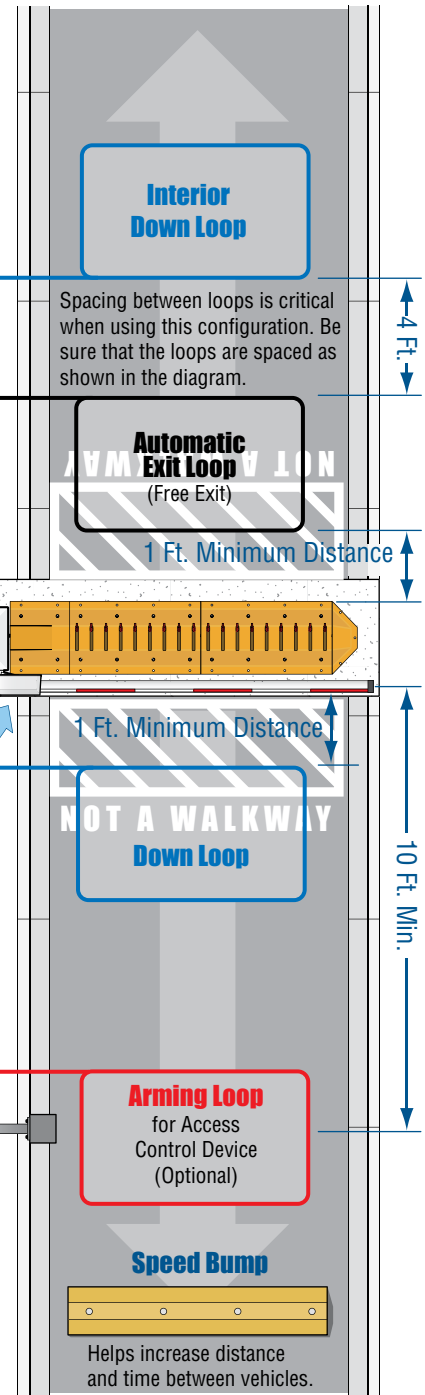

4.4 Ticket Spitter Entry Lane

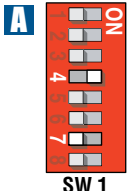

SW 1, switch 4 is **ON**.
 SW 1, switch 7 is **OFF** (Timer). The arm will rotate down after the vehicle clears the down loop. See note below.

Type of wiring to be used on ALL external devices:
A) Type CL2, CL2P, CL2R, or CL2X.
B) Other cable with equivalent or better electrical, mechanical, and flammability ratings.

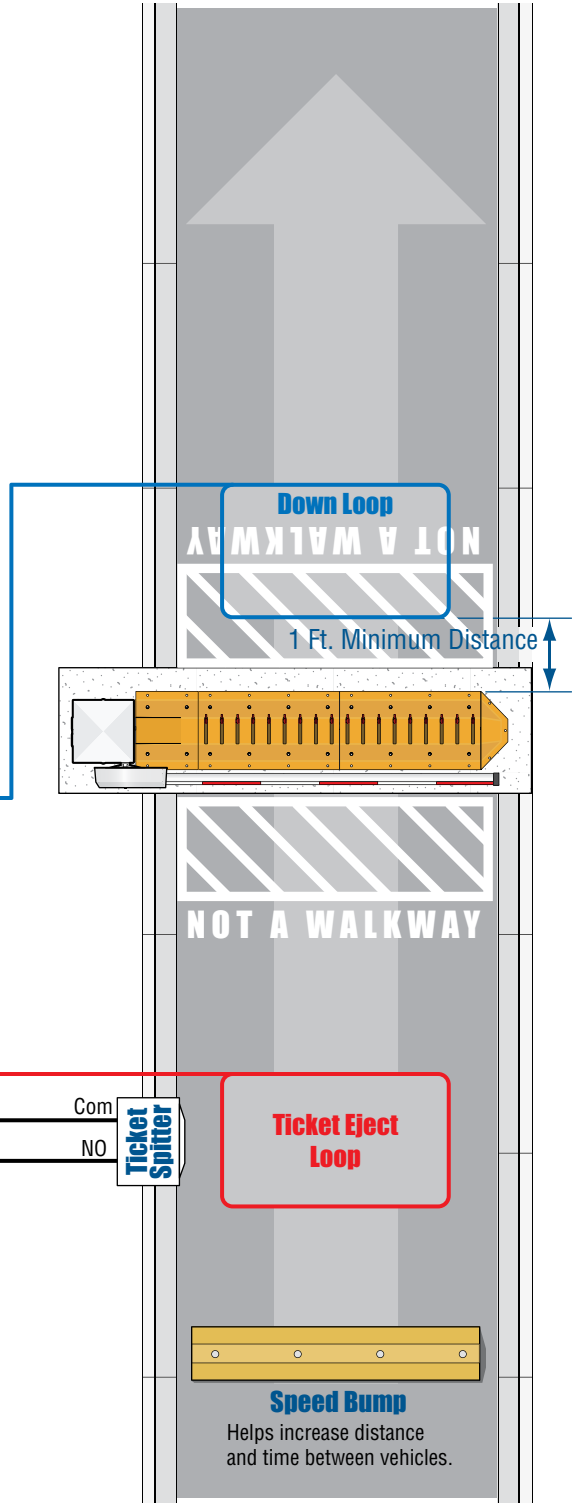
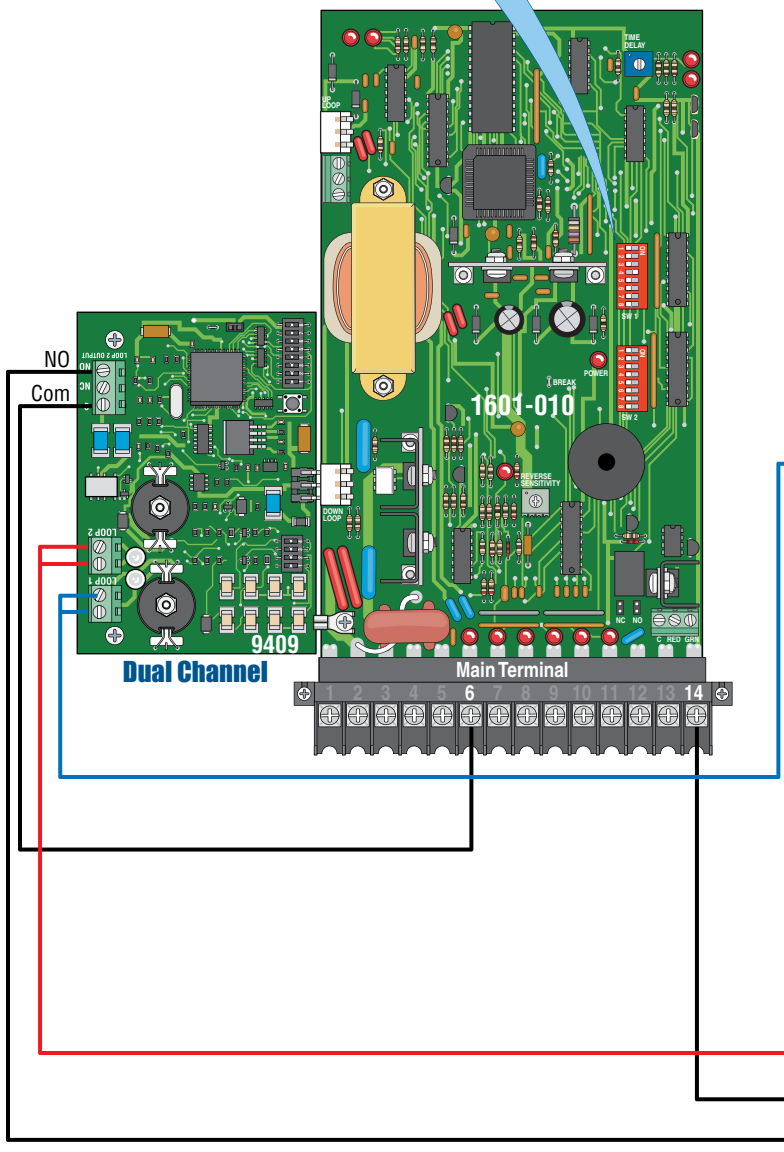

Note: The timer can be used with a down loop. When timer is ON with a down loop, it will start countdown when the arm has fully raised. Activation of the down loop will cancel timer countdown. Useful when the ticket spitter has been activated but vehicle does not move forward to activate the down loop. **The arm will remain UP.** Timer will time out and lower the arm without the down loop being activated.

4.5 Operator Timer ON Entry Lane (No Down Loop)

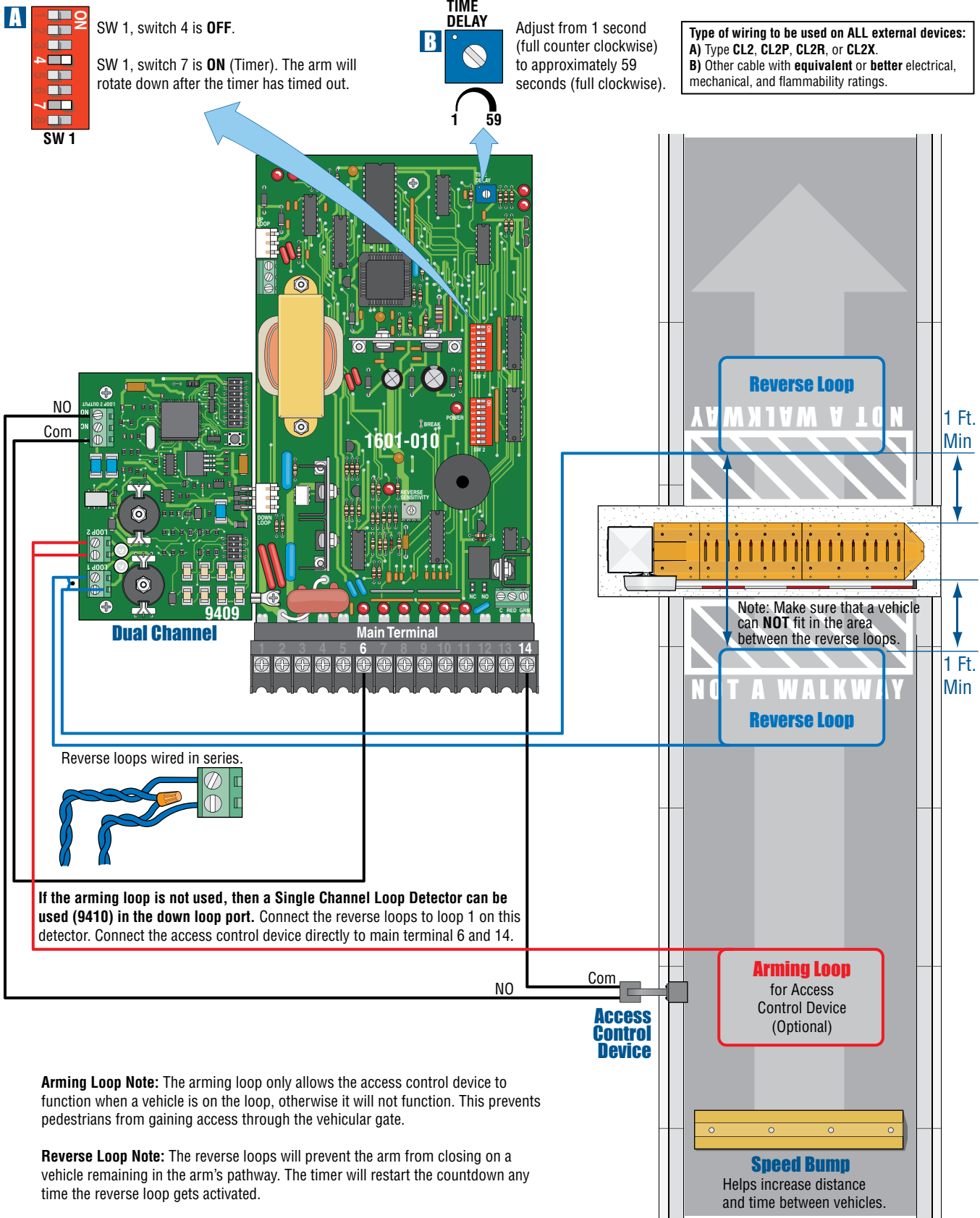

Arming Loop Note: The arming loop only allows the access control device to function when a vehicle is on the loop, otherwise it will not function. This prevents pedestrians from gaining access through the vehicular gate.

Reverse Loop Note: The reverse loops will prevent the arm from closing on a vehicle remaining in the arm's pathway. The timer will restart the countdown any time the reverse loop gets activated.

SECTION 5 - ARM INSTALLATION

The 14 ft. aluminum arm mounts on the same side of the operator as oncoming traffic (either straight or folding arm).

5.1 Mounting Hub

Operator in the **Down** position.

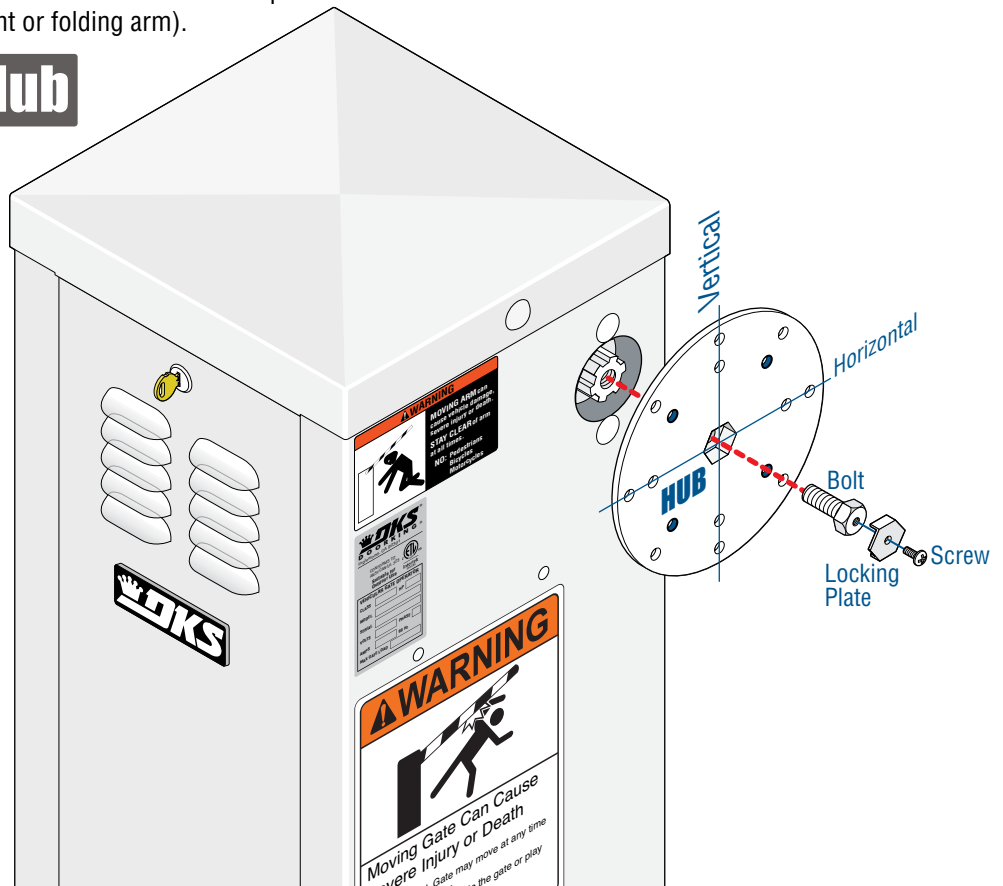

5.2 Mounting Aluminum Arm

Refer to instruction sheet that comes with **YOUR CHOSEN ARM** to install arm. Arm options are on the 1603 specifications page in front of this manual.

Note: Make sure Warning decals are on **BOTH** sides of arm.

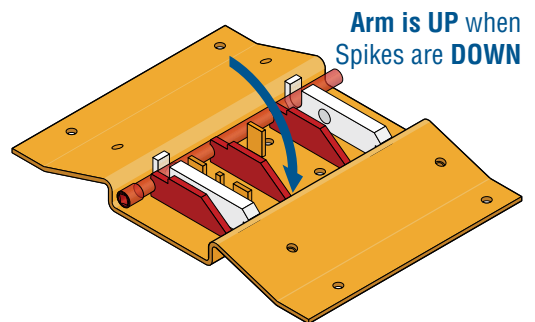
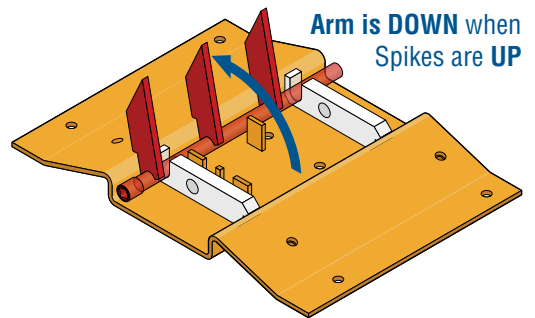
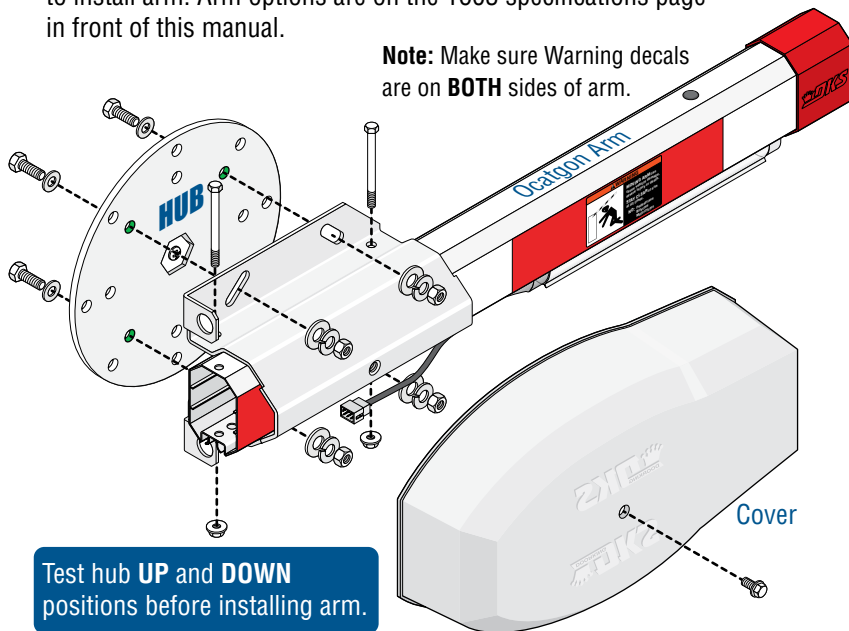

Note: Helpful wiring diagram on page 35 if installing a octagon reverse edge/LED arm **AND** a traffic light.

SECTION 6 - ADJUSTMENTS

The switch settings and adjustments in this chapter should be made after your installation and wiring to the operator is complete. **Whenever any of the programming switches on the circuit board are changed, power must be shut-off, and then turned back on for the new setting to take effect.**

6.1 1601 Circuit Board Description and Adjustments

Gate Tracker Activity LED

An automatic sensor system that senses entrapment of a solid object and is incorporated as a permanent and integral part of the operator.

Gate Operator Data Terminal

Operator status reporting; cycle count, shorted inputs, loop detector problems, power interruptions, etc. See page 7.

Auto Close Timer

Auto close timer (when turned on) SW 1, switch 7.

Adjust from 1 second (full counter clockwise) to approximately 59 seconds (full clockwise).



SW 1



1 59

How LEDs Function



Illuminated LEDs Indicates that low voltage power is being applied to the circuit board.

Input LEDs should be OFF and will only illuminate when the input is activated.

Limit LEDs will only illuminate when the respective limit sensor has been activated.

Self Test

Self test (when turned on) SW 1, switch 2.

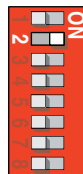

SW 1

Up Limit LED
Down Limit LED

Limit Sensor
See page 22.

DIP-Switches

Set the DIP-switches on the circuit board to the desired setting. See switch settings information on the next 3 pages.

Note: SW 2, switch 1 **MUST** be set for the correct model operator that has been installed.

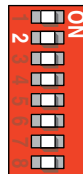

SW 1



SW 2

LED Lights Terminal (C – NC – NO)

This solid state switch can be used for a variety of purposes and is typically used to signal when the arm is up or down. 12VDC @ 6 amp max. if connecting a relay.

Dry Relay Contact

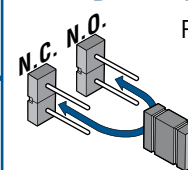

Relay activation is dependant on setting of SW 1, switch 5.



SW 1

Dry relay contacts (terminals 12-13) can be set for Normally Open (NO) or Normally Closed (NC) operation by placing the relay shorting bar on the N.O. or N.C. pins respectively. See page 6 and next page. 24V AC or DC @ 1 amp max.

Single Channel Loop Detector

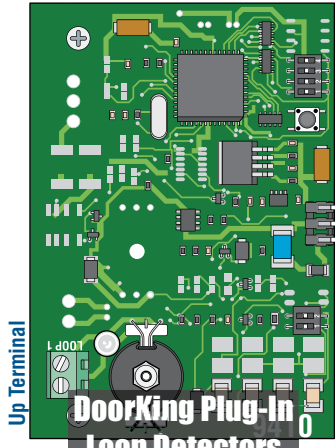

Up Terminal

DoorKing Plug-In Loop Detectors

(Sold separately)

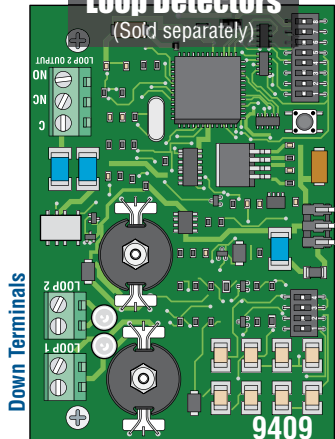

Down Terminals

Dual Channel Loop Detector

Reverse Sensor

Adjust reversing sensitivity for the DOWN direction of arm. See page 22.

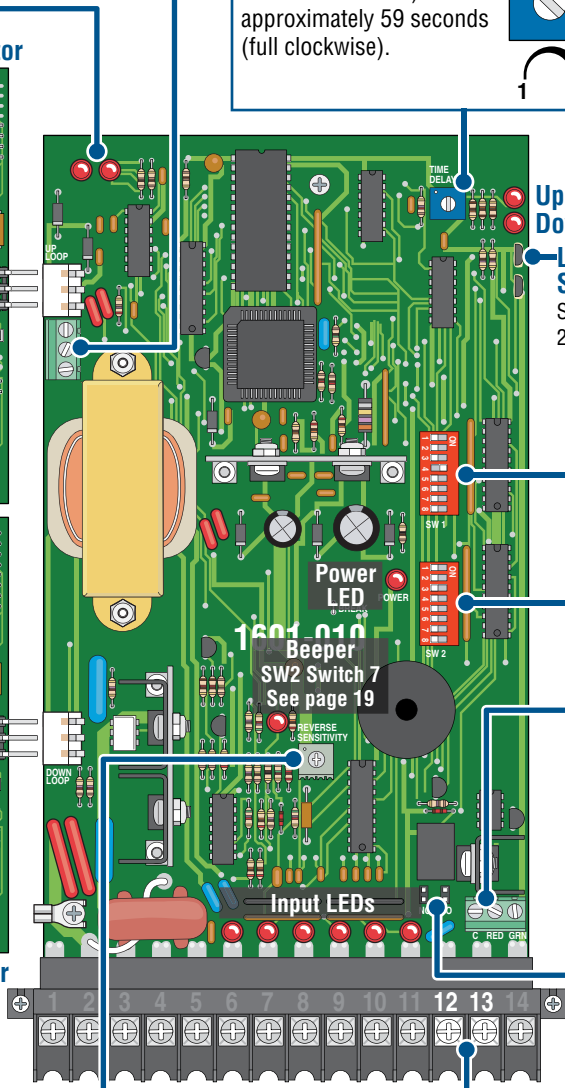
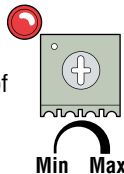

Power LED

Beeper

SW2 Switch 7

See page 19

REVERSE SENSITIVITY

Input LEDs

SW 1

SW 2

TIME DELAY

UP LOOP

DOWN LOOP

1 2 3 4 5 6 7 8 9 10 11 12 13 14

C RED GRN

6.2 DIP-Switch SW 1 and SW 2 Settings

The two DIP-switches located on the circuit board are used to program the operator to operate in various modes and to turn on or off various operating features. Whenever a switch setting is changed, power to the operator must be turned OFF and then turned back on for the new setting to take affect. Check and review ALL switch settings prior to applying power to the operator.

SW 1 (Top 8 Switches)			
Switch	Function	Setting	Description
1	Down Active when arm is full up.	OFF	Activation and then deactivation of the down loop or down / reverse input will cause the arm to rotate down ONLY if the deactivation occurred after the arm reached the FULL UP position.
	Down Active when arm is moving up or is up.	ON	Activation and then deactivation of the down loop or down / reverse input will cause the arm to rotate down AFTER reaching the FULL UP position regardless of when the deactivation occurred.
2	Self-Test	OFF	Normal setting. Self-test is turned off.
		ON	Run self-test.
3	Gear Box Travel	OFF	Normal setting. Operator uses 360° of gearbox. Extends wear life of gearbox.
		ON	Operator uses 180° of gearbox.
4	Down / Reverse Loop and Input	OFF	Down / Reverse loop and input will function as a REVERSE loop and REVERSE input.
		ON	Normal setting. Down / Reverse loop and input will function as a down input and cause the arm to rotate down upon deactivation of the input. See SW 1, switch 1 for additional information.
5	Relay 1 Activation	OFF	Normal setting. Relay activates when the DOWN loop detector (DoorKing plug-in detector only) senses a vehicle presence.
		ON	Relay activates when the UP loop detector (DoorKing plug-in detector only) senses a vehicle presence.
6	Up Input Function	OFF	Up Input will raise arm and/or reset the down timer. Input will not lower the arm.
		ON	Up Input will raise arm if it is down, or will lower arm if it is up.
7	Timer	OFF	Timer to lower arm is OFF.
		ON	Timer to lower arm is ON. Set from 1 to 59 seconds for close time delay. Timer can be used as a secondary closing command for a down loop. Timer countdown starts when arm has fully raised. Down loop activation will cancel timer and lower arm OR arm will lower when timer has timed out.
8	Up Loop Port Input	OFF	Output of the loop detector plugged into the UP loop port is switched to terminal 7 for connection to other input terminals.
		ON	Normal setting. Output of the loop detector plugged into the UP loop port will raise arm when activated.

SW 2 (Bottom 8 Switches)			
Switch	Function	Setting	Description
1	Model 1603	OFF	Switch must be OFF for model 1603 barrier gate operator.
2	Multiple Input Memory ON/OFF Switch	OFF	Normal setting. Operator will respond to a single UP command, then require a DOWN command. Operator will not accept multiple Up commands. Operator will not accept the next UP command until the previous DOWN command is in progress.
		ON	Turns ON the multiple input memory option 1 or 2 (See switch 3). SW 1, switch 4 must also be on.
3	Multiple Input Memory Options (SW2, Switch 2 must be ON) (SW1, Switch 4 must be ON)	Option 1 (OFF Position)	Override a DOWN command – When the arm is in the up position for a vehicle passing through and the next vehicle's UP command is received, the operator will hold the arm up and wait for the next vehicle to clear the down loop before lowering the arm. The operator will not count multiple UP commands. Distance between access control device and barrier operator is a factor when using this option. Remote transmitters recommended for this option. See next page for more information.
		Option 2 (ON Position)	Override Multiple DOWN commands – The operator will count multiple UP commands received during an UP command and require a matching number of DOWN commands before lowering the arm. Distance between access control device and barrier operator is a factor when using this option. Remote transmitters NOT recommended for this option. See page 21 for more information.
4	Stop Arm Function	OFF	Normal setting. Arm will NOT stop DURING the down cycle.
		ON	Stop Arm Function – Arm will stop DURING the down cycle if a vehicle activates the down loop. An UP command will raise the arm, or the arm will continue down AFTER the down loop is cleared.
5	Reverse Delay	OFF	Arm reversal is delayed approximately .5 seconds when a reverse input from terminal 9 is received during the down cycle. (eg. non-contact sensor beam is blocked). Limited application use.
		ON	Normal setting. Instant Reverse – Arm reversal is delayed approximately .1 second when a reverse input from terminal 9 is received during the down cycle. (eg. non-contact sensor beam is blocked)
6	Arm Rotation Direction	OFF	Normal setting. Leave in OFF position.
7	Warn Before Operate Beeper	OFF	Beeper will beep 2 times before lowering arm ONLY when the TIMER times out. If using a down loop, when it gets activated, it will cancel the timer and lower arm WITHOUT beeping.
		ON	Beeper will beep 2 times before lowering arm EVERYTIME.
8	Spare	OFF	Normal setting. Leave in OFF position.

Option 1 - Override a DOWN Command SW2, Switch 3 OFF

Remote transmitters are recommended for this option.

Basic operator UP/DOWN cycle:
A. Valid **UP** command from the access control device will raise arm.
B. Vehicle activating and clearing the down loop will lower the arm.

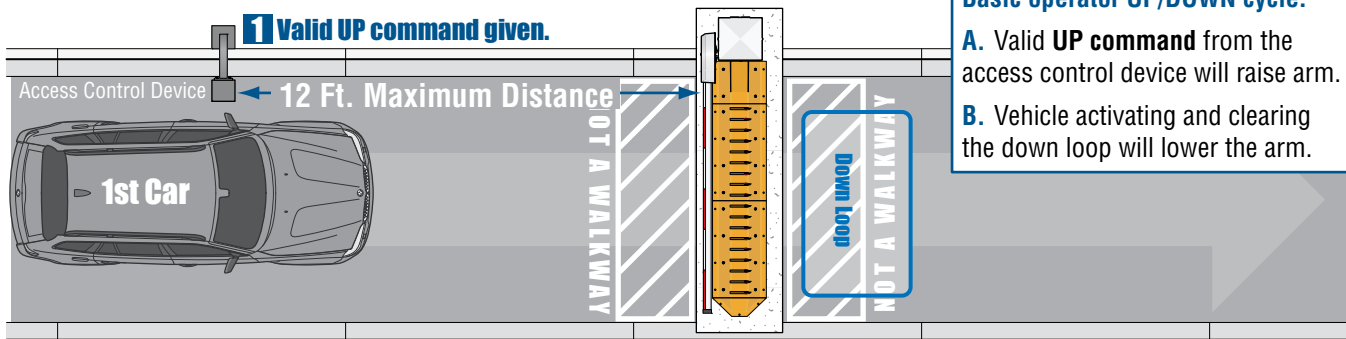

Option 1 CANNOT be used at distances OVER 12 feet. This allows multiple vehicles in this area which Option 1 **WILL NOT** keep track of. See Option 2 on next page.

2 Operator will raise arm.

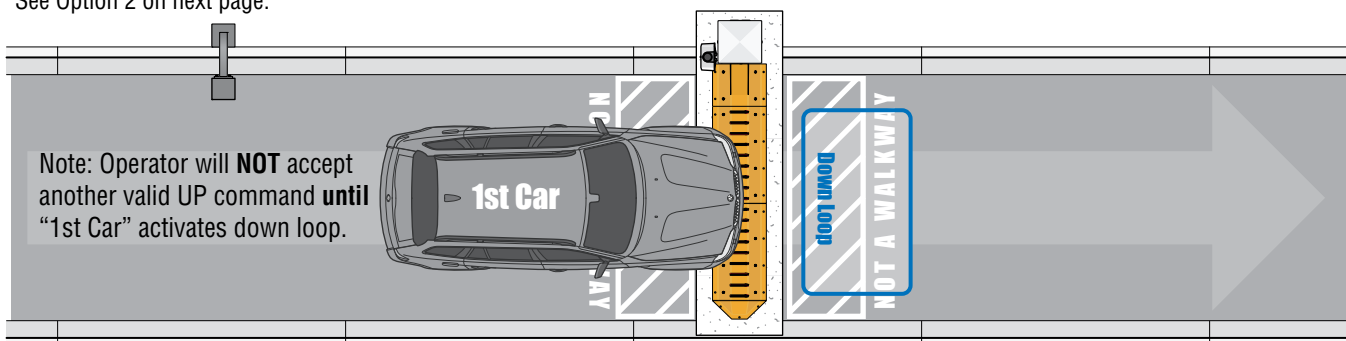

3 1st Car activates down loop.

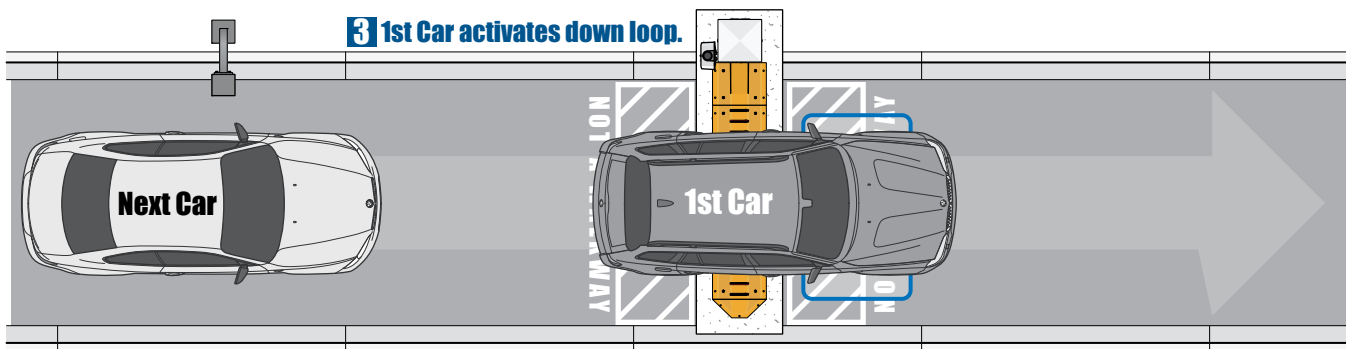

4 While 1st Car is on down loop, the next UP command is given.

5 Operator will override "1st Car's" DOWN command. Arm will remain up and wait for the "Next Car's" down loop to be activated.

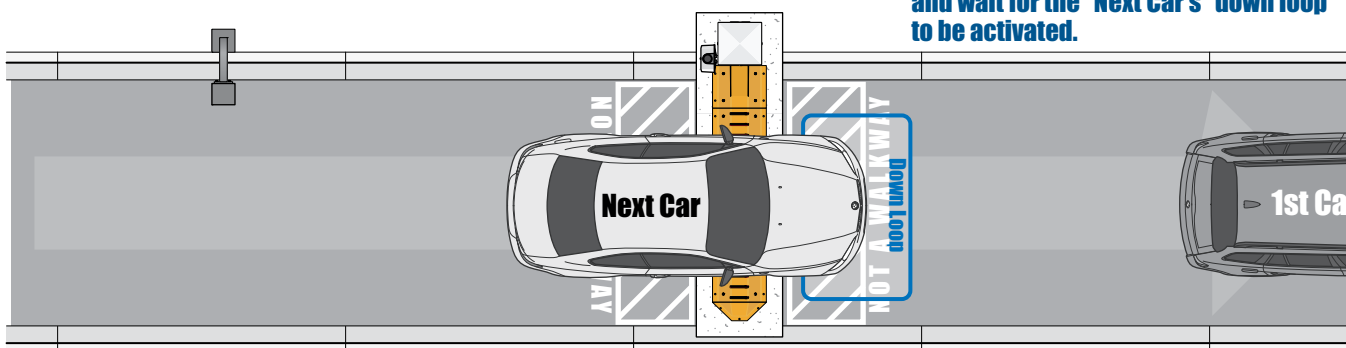

Note:
 If an UP command is given while the arm is lowering, the arm will raise.

6 When "Next Car" activates then clears down loop, arm will lower.

Option 2 - Override Multiple DOWN Commands sw2, switch 3 ON

Basic operator UP/DOWN cycle:

- A. Valid **UP** command from the access control device will raise arm.
- B. Vehicle activating and clearing the down loop will lower the arm.

This option allows the access control device and the barrier gate operator to have multiple vehicles in the area between them. The operator will count all the valid UP commands received and require a down loop activation for each one. The arm will lower only after the last vehicle activates then clears the down loop.

Remote transmitters are **NOT** recommended for this option because **one vehicle's remote** can accidentally be pressed **multiple times** which will get counted by the operator as multiple vehicles.

Note:
If an UP command is given while the arm is lowering, the arm will raise.

1 Valid UP command given

Access Control Device

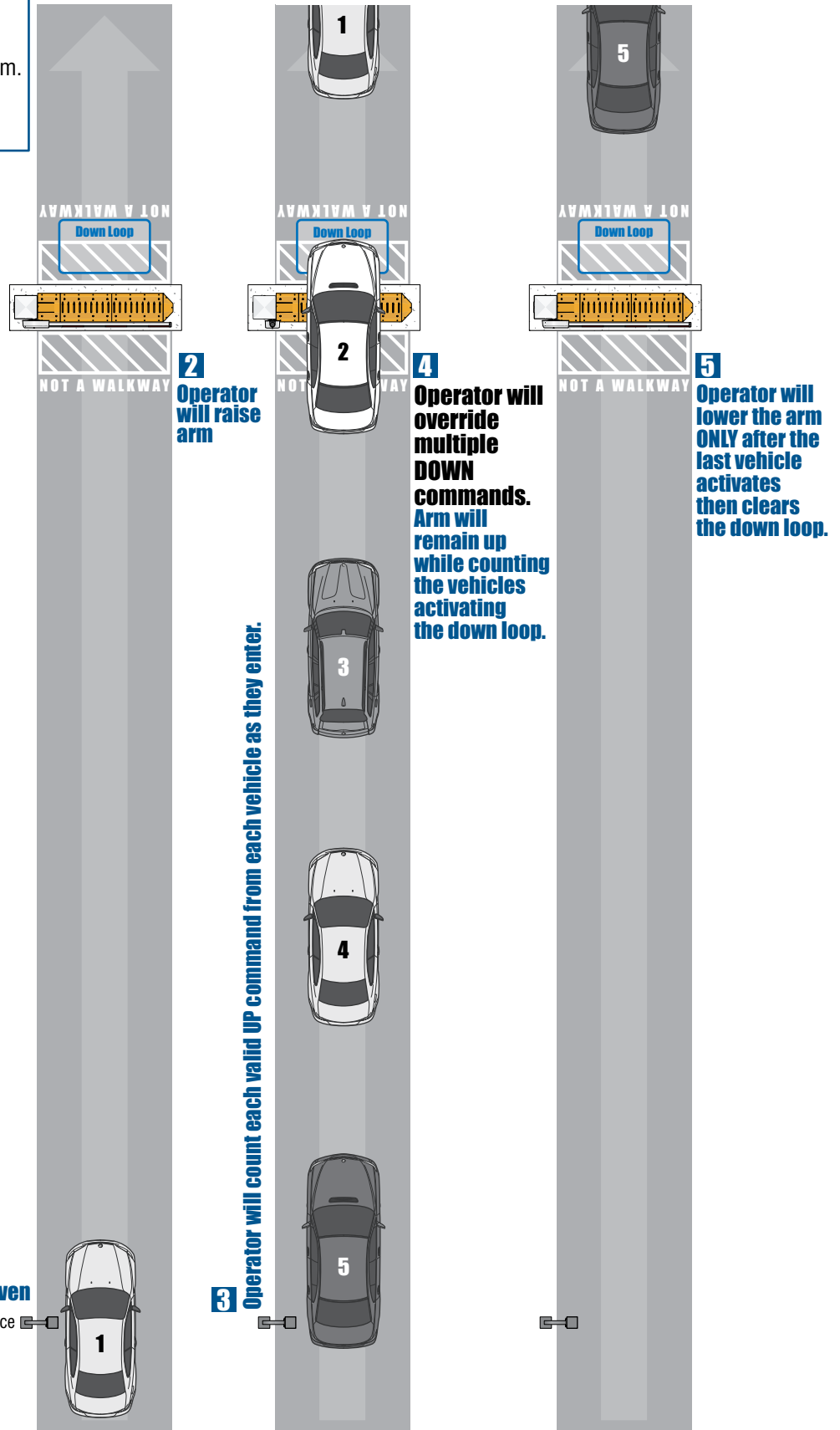

6.3 Magnetic Limit Adjustments

The operator has been preset at the factory to rotate 90°. **No adjustments are necessary when used in a normal 90° setup.**

If the arm needs to rotate less than 90°:

- 1** Turn operator power **OFF**.
- 2** Set the DIP-switch SW 1, switch 3 to **ON**. This changes the rotation of the gearbox from 360° to 180° allowing the gearbox to rotate the arm less than 90°.
Note: The arm will **always** cycle to 90° open with the 360° gearbox setting.
- 3** Loosen magnet limit assembly nuts and slide the assemblies to the desired **UP** and **DOWN** positions. Tighten nuts when desired positions are achieved.

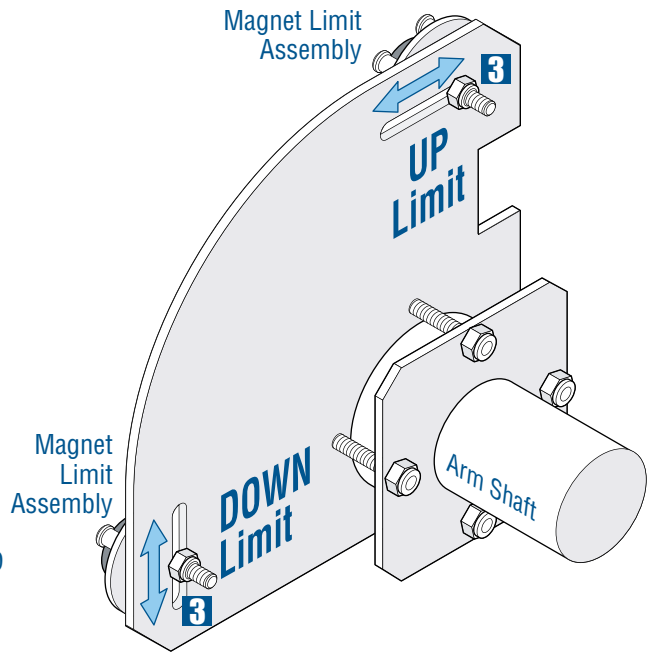
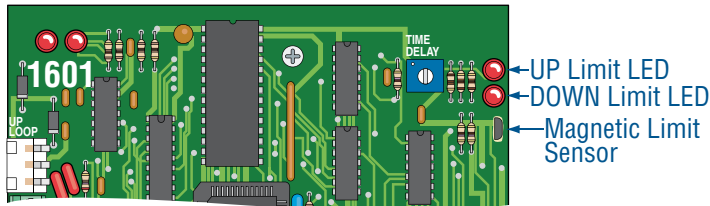
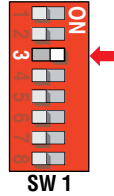

6.4 Reverse Sensor

Reverse sensitivity adjustment will cause the barrier arm to reverse direction of travel should an object be encountered during the down cycle. The amount of force required for the arm to reverse direction depends on the reverse sensitivity potentiometer.
CAUTION: Keep pedestrians and vehicles clear of the arm zone while adjusting sensor!

While operator has AC power:

- 1** Turn control switch to **UP**. Arm will rotate UP.
- 2** Turn control switch to **DOWN**. While arm is traveling down, rotate reverse sensor clockwise until the **reverse LED lights up** and the arm reverses direction. Rotate reverse sensor back counterclockwise approximately 1/8 turn.
- 3** Repeat the adjustment as needed to find a satisfactory setting.

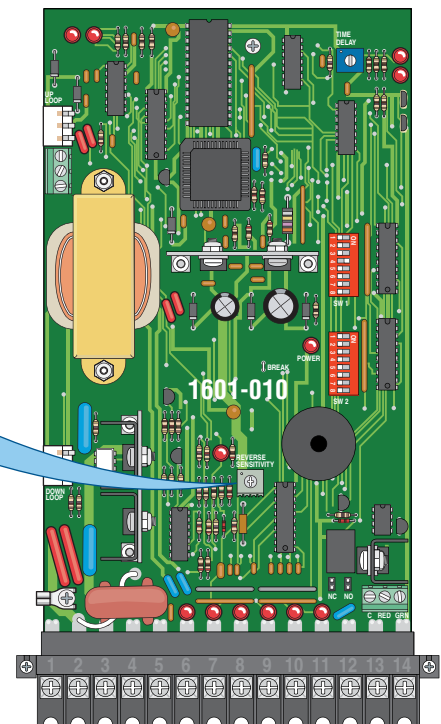
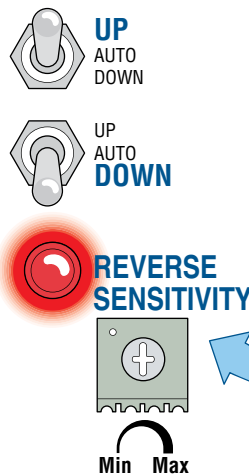

6.5 Manual Operation of Arm and Spikes

- 1 Unlock and remove access door.
- 2 Remove crank tool from inside access door.
- 3 Flip interlock assembly door up, **ALL** power will be disabled from operator, including battery back-up power on convenience open models.
- 4 Insert crank tool into motor pulley as shown.
- 5 Rotate crank tool to manually move operator arm and spikes up or down.

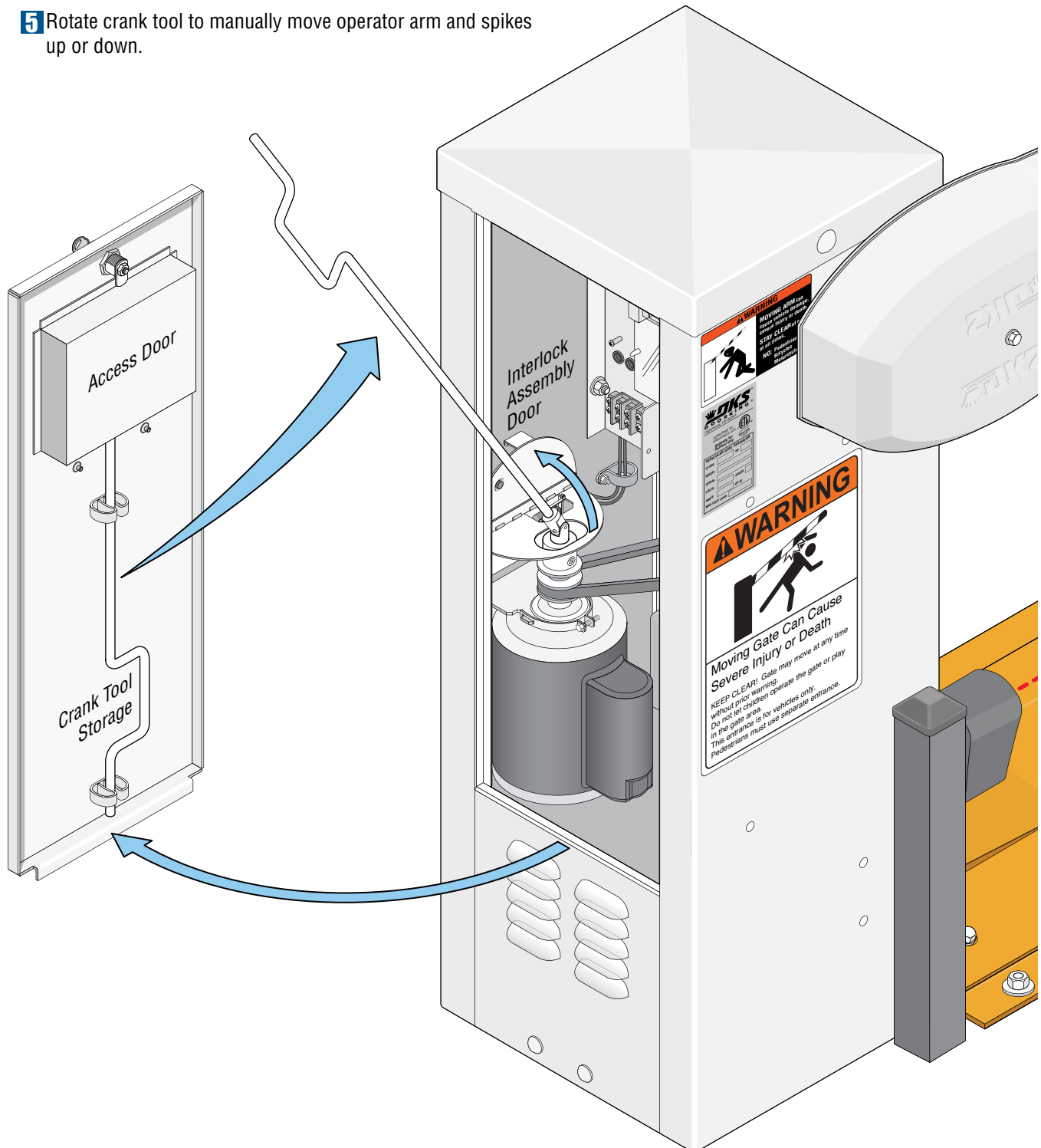

SECTION 7 - OPTIONAL CONVENIENCE OPEN SYSTEM

The optional convenience open system installed in your vehicular gate operator is designed as a convenience enhancement only. It is not designed or intended to provide continuous gate operation during a power outage. Its sole purpose is to provide a method to open the vehicular gate to allow unimpeded traffic flow when the gate and access control system is without power. If your access control system requires 100% power backup and continuous operation when primary (AC) power has failed, a power inverter / backup system, such as DoorKing's Model 1000 is required.

- The convenience open system **cannot** provide continuous gate operation during a power outage.
- **This system cycles the arm to the open position one time only after AC power failure.**
- The convenience open system requires testing on a monthly basis to insure the batteries are fully charged and that the system is operational.
- The convenience open system uses two 12-volt, 3.0 amp-hour gel-cell batteries. These batteries should be replaced every two years on average, or sooner if required.
- Batteries are affected by temperature. Cold temperatures will reduce the effectiveness of the batteries. High temperatures will result in a shortened battery life.
- Batteries are not covered under warranty.

7.1 Circuit Board Settings and Descriptions

This convenience open system consist of a control board (1473-010), motor and power supply (batteries) providing a completely redundant drive system to open the barrier arm should a power outage occur. This system is not designed to maintain continuous barrier operation; rather it provides a convenient method to open the arm **once** during adverse conditions. **If continuous barrier and access control system operation is required, refer to the DoorKing Model 1000 Inverter / Backup Power System.**

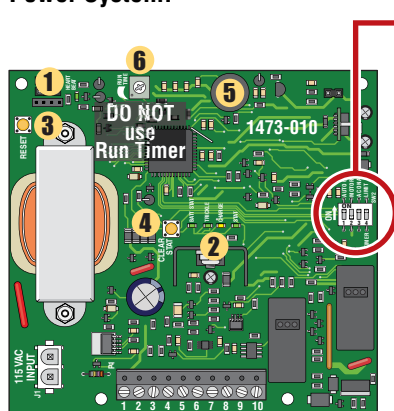

DIP-Switches

Switch	Function	Setting	Description
1	Auto Open Operation After Power Outage	OFF	DO NOT USE. Manual Mode.
		ON	(Auto Mode) Apartment complexes, gated communities, etc.: Arm will automatically raise to the operator's UP limit position.
2	Motor Dir Motor Direction	OFF	Set so that the arm opens to the UP direction upon loss of AC power.
3	AC on ACT Restore Power Operation	OFF	DO NOT USE. Physical Input Required.
		ON	Auto: a 1-second pulse is automatically sent to the barrier gate operator input to restore normal operation again.
4	Timer-OFF Limit-ON Operator Type	Timer-OFF	DO NOT USE. "Run timer" is used and MUST be adjusted.
		Limit-ON	Operator limits are used to stop arm at UP position.

- HEART BEAT LED**
Blinking: Indicates board is operating normally.
- Battery LEDs**
BATT STAT LED
2 Blinks: Replace batteries.
3 Blinks: Battery level is too low.
4 Blinks: Batteries are not connected.
5 Blinks: Bad battery.
6 Blinks: Battery charge current exceeds maximum, possible shorted cell.
- TRICKLE LED**
Steady Green LED: Battery is fully charged and a trickle charge is being used to maintain a full charge.
- CHARGE LED**
Steady Yellow LED: Battery is being bulk charged.
Blinking Yellow LED: Battery is 90% of a full charge.
- STAT LED**
3 Blinks: Extreme temperature, charging suspended.

- Reset Button**
Press to reset board.
- Clear Stat Button**
Press and hold the **CLEAR STAT** button for 4 secs clears the battery replacement reminder counter and resets the beeper. LEDs will also indicate battery status.
- Beeper**
A beep every 20 seconds indicates that battery replacement is needed. Press and hold the **CLEAR STAT** button to reset the battery reminder beeper and clear the counter. LEDs will also indicate battery status.
- Run Timer**
DO NOT USE.

Operating Note: Arm will cycle to UP position **automatically** (DIP-Switch 1 ON) during an AC power failure. Operator's DC limit sensor will stop and hold the arm in the UP position (DIP-Switch 4 ON). Operator will **automatically** return to normal operation once AC power has been restored (DIP-Switch 3 ON).

Initial Power Up Convenience Open Note: The DC power is not present on the main circuit board until the **first** initial cycle.

7.2 DC System Wire Schematic

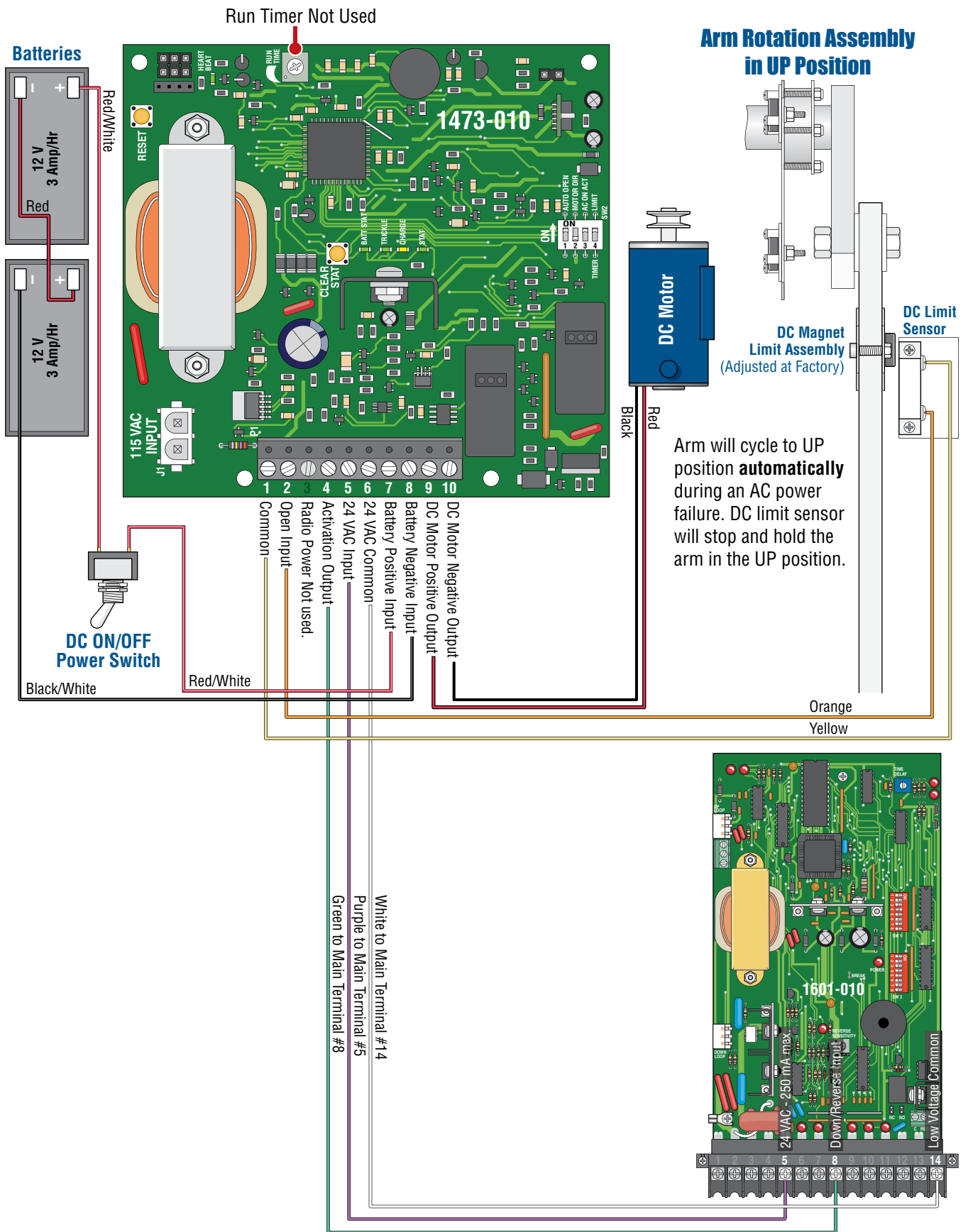

SECTION 8 - OPTIONAL ACCESSORIES INSTALLATION

8.1 Contact Sensor Installation (Reversing Edge)

In addition to the electronic reversing device (ERD) an optional electric reversing edge may be installed on **Round Aluminum arm ONLY** offering additional protection. P/N 8080-071 - 2-wire 6 ft. P/N 8080-091 - 4-wire 6 ft.

Contact Sensor Note:

A reverse edge is **NOT** to be used as a replacement, or in lieu of, in-ground loops or non-contact sensor (photozell) that protect vehicles passing underneath the barrier arm. A moving vehicle coming in contact with a downward moving barrier arm **WILL** result in **damage to the vehicle** and the barrier arm/reversing edge if **NOT** using in-ground loops or non-contact sensor (Photozell).

1 Turn operator power **OFF**. Remove Cover.

2 Position the mounting channel at the end of the barrier arm and secure to the bottom of the arm using self-tapping metal screws (not supplied). Slide the reversing edges into the mounting channels.

3 Drill a 1/4-inch hole on the side of the operator housing beneath the operator arm shaft and not interfering with the internal components.

4 Install a plastic grommet (Not supplied) in the 1/4" hole to protect the wire from chaffing on sharp metal edges.

5 Secure the wire to the arm and hub using wire ties (not supplied). Leave a wire loop to allow the arm to rotate freely. Make sure wire does not rub against the cover when cycling.

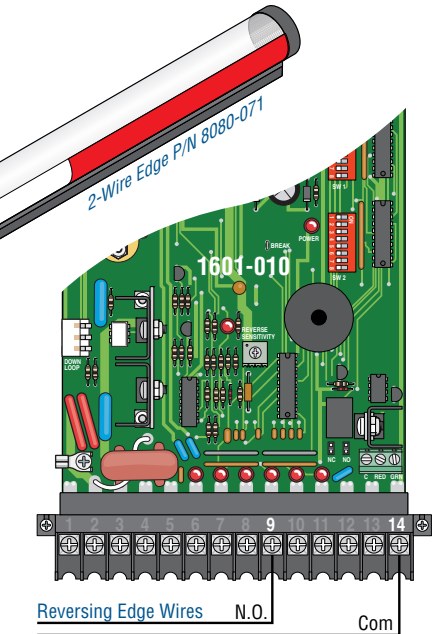

6 Connect wires to terminals 9 and 14 without interfering with any of the operator's moving parts. Re-install cover.

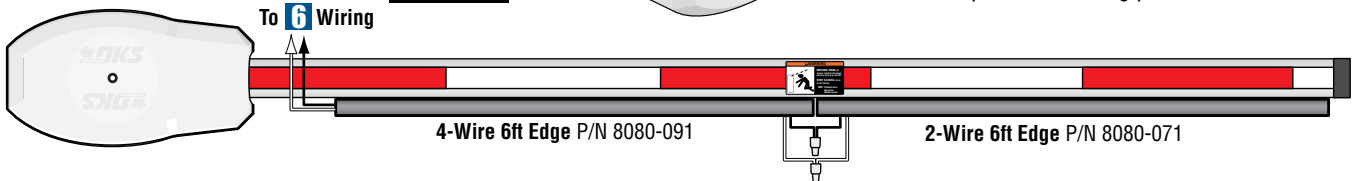

8.2 Additional Optional Accessories

“Optional” accessories offering additional features, available from DoorKing.

Fan Kit

This kit is designed for the 1603 barrier gate operator. It is recommended for hot humid climates to prevent heat and moisture build-up inside the housing (P/N 1601-093).

For further information about this, go to DoorKing’s web site at: www.doorking.com

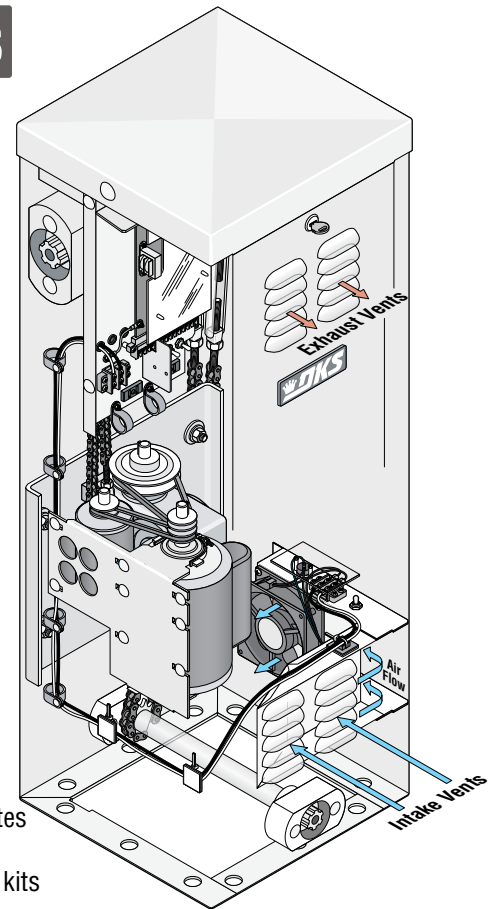

Heater Kits

These kits are designed for the 1603 barrier gate operator. For cold weather climates where temperatures routinely drop below 10°F (-12°C). A built-in thermostat will automatically control the temperature inside operator housing. There are different kits depending on the input power wire being used to power the barrier gate operator. For further information about these, go to DoorKing’s web site at: www.doorking.com

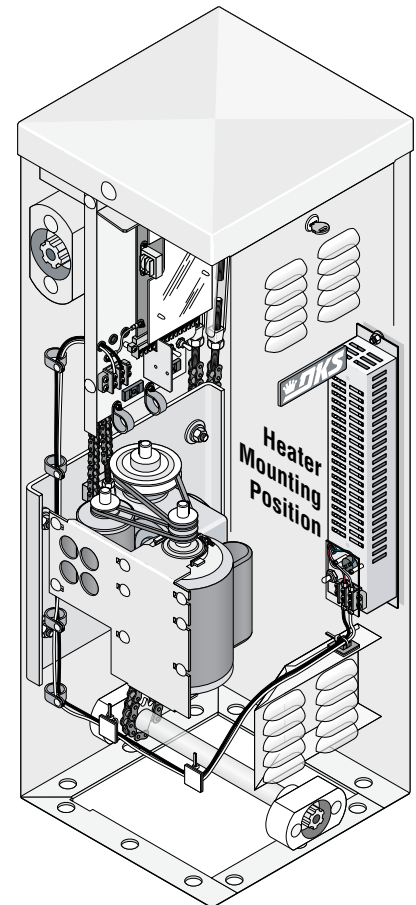
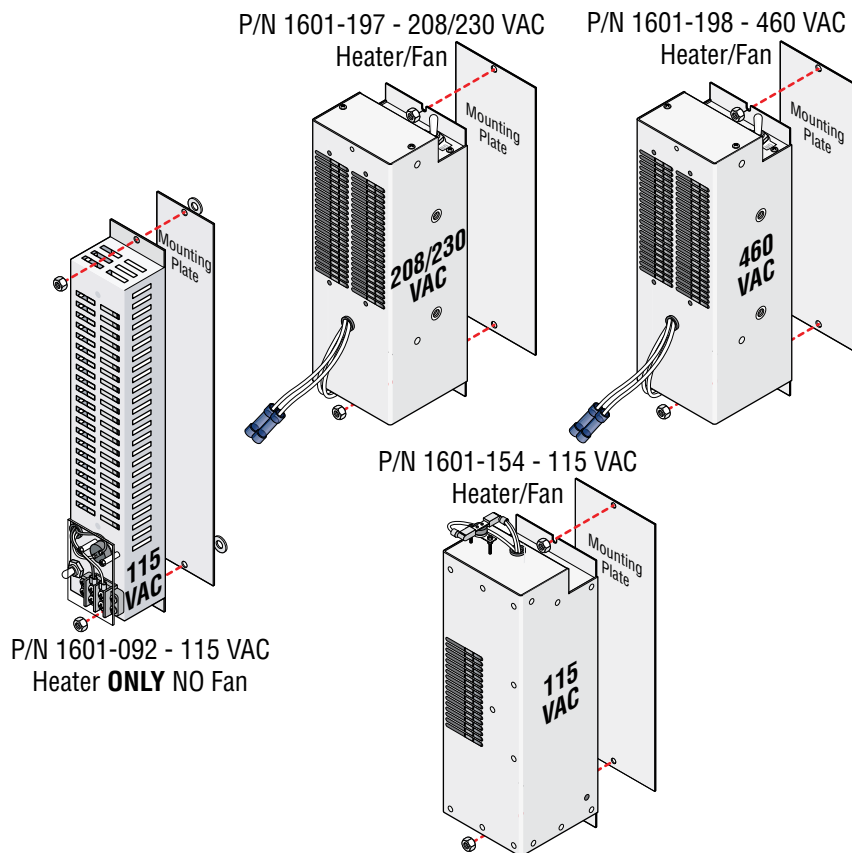

8.2 Additional “Optional” Accessories

“Optional” accessories offering additional features, available from DoorKing.

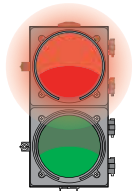

LED Traffic Light

This kit is designed for the 1603 barrier gate operator. The traffic signal is synchronized with the gate operator's up/down cycle. The red light stays on and only changes to green when the operator's arm is fully raised and spikes are down.

P/N 1603-221 - 6 Ft Cable with NO Post

P/N 1603-222 - 6 Ft Cable with 35" Post

P/N 1603-223 - 11 Ft Cable with 95" Post

For further information about this, go to DoorKing's web site at: www.doorking.com

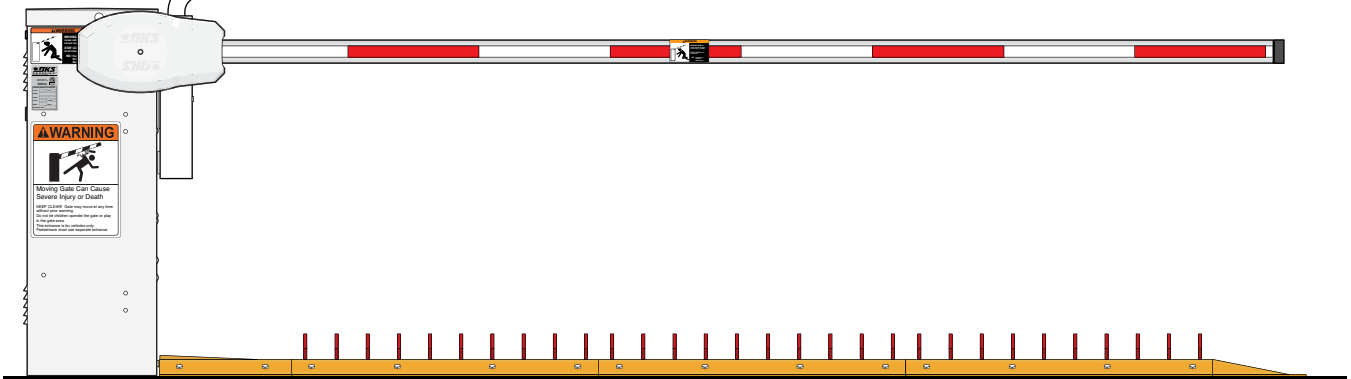

Lighted Warning Sign

This kit is designed for the 1603 barrier gate operator. The warning sign has a light sensor for automatic dusk to dawn illumination and a manual On-Auto/Off switch. P/N 1615-081
For further information about this, go to DoorKing's web site at: www.doorking.com

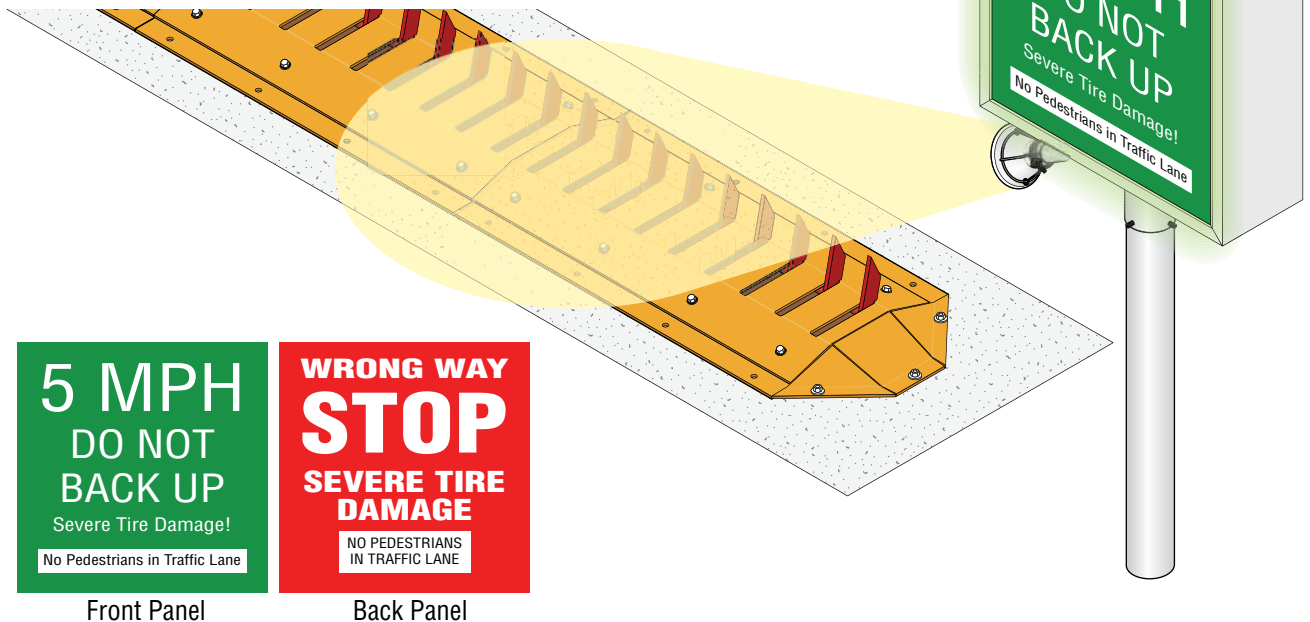

SECTION 9 - MAINTENANCE AND TROUBLESHOOTING

Inspection and service of this gate operator by a qualified technician should be performed anytime a malfunction is observed or suspected. High cycle usage may require more frequent service checks.

9.1 Maintenance

When servicing the gate operator, always check any external reversing devices (loops, photo eyes, etc.) for proper operation. If external reversing devices cannot be made operable, do not place this operator in service until the malfunction can be identified and corrected.

Always check the inherent reversing system when performing any maintenance. If the inherent reversing system cannot be made operable, remove this operator from service until the cause of the malfunction is identified and corrected. Keeping this operator in service when the inherent reversing system is malfunctioning creates a hazard for persons which can result in severe injury or death should they become entrapped.



If replacing arm, make sure warning decal is on both sides of arm.

When servicing this gate operator, always turn power **OFF!!** If equipped with batteries, make sure battery power switch is **OFF**.

If gearbox requires oil, use only Mobil SHC-629 Synthetic Gear Oil. Do not completely fill gearbox with oil. Gearbox is full when oil completely covers inspection window.

Operator Component	Maintenance	Monthly Interval		
		1	6	12
Arm(s)	Check for alignment, tightness and wear.		✓	✓
Auto Spike System	Check for shaft alignment, tightness of hardware and wear of spikes. Make sure all tunnel plates and ramps are securely fastened to concrete.			✓
Drive Belts	Check for alignment, tightness and wear.		✓	✓
ERD Reversing System	Check that the arm reverses on contact with an object in closing cycle. Adjust the reversing sensor if necessary.	✓		✓
Batteries (On select models)	If operator is equipped with optional convenience open system, check the batteries for any leakage or loose connections. Batteries should be replaced every two years.	✓		
Convenience Open System (Not on all models)	If operator is equipped with optional DC open system, check to be sure the system opens the arm upon loss of AC power. Operator should resume normal operation when AC power has been restored.	✓	✓	✓
Fire Dept.	Check emergency vehicle access device for proper operation.	✓		✓
Gearbox	Check oil level and fill if necessary. Do not overfill.			✓
Linkages	Check internal linkages for wear. Inspect bushing for wear.		✓	✓
Loop(s)	Check all external ground loops for proper operation.	✓		✓
Pulleys	Check set screw for tightness.		✓	✓
External Reverse Device(s)	Check electric reversing edges and photo-cells for proper operation.	✓		✓
Complete System	Perform a complete system check. Include all reversing devices, loops, access system devices, Fire Dept. access devices, etc.			✓

9.2 Diagnostics Check

Have the following diagnostic tools available: VOM meter with minimum voltage memory or min-max range to check voltage and continuity. Meg-ohm meter capable of checking up to 500 megohms of resistance to properly check ground loop integrity.

A malfunction can be isolated to one of the following:

- Gate Operator
- Loop System
- Keying Devices.

Disconnect all external inputs to the circuit board terminal.

1. Use caution when checking high voltage areas: terminals 1 through 6, the motor capacitor and the motor.
2. Check the input indicator LED's. They should only come ON when a keying device (card reader, push button, etc.) is activated. If any of the input LED's are ON continuously, this will cause the gate operator to hold the arm up. Disconnect the keying devices one at a time until the LED goes OFF (see troubleshooting guide).
3. If the operator stops or holds open, check external entrapment protection devices for any shorts or malfunction.
4. A malfunction in a loop or loop detector can cause the gate operator to hold the arm up, or not detect a vehicle when it is present over the loop. Pull the loop detector circuit boards from the loop ports on the operator circuit board. If the malfunction persists, the problem is not with the loop system. For more information refer to the loop detector instruction sheet and the DoorKing Loop and Loop Detector Information Manual.
5. Check that there are no shorted or open control wires from the keying devices to the gate operator. If a keying device fails to open the arm, momentarily jumper across terminals 6 and 14 on the control board terminal. If the gate operator starts, this indicates that a problem exist with the keying device and not with the gate operator.
6. Check the supply voltage and batteries. A voltage drop on the supply line (usually caused by using wires that are too small) will cause the operator to malfunction. Batteries should be fully charged for proper operation, replace batteries every two years on average.

9.3 Troubleshooting

Symptom	Possible Solution(s)
Operator will not run. Power LED is OFF.	<ul style="list-style-type: none">• Check that power to the operator is turned ON.• Check for 117 VAC with a voltmeter at control board terminals 1 and 2. If voltage measures 0, check power supply to operator or check terminal strip. If voltage measures OK, replace control board.

9.3 Troubleshooting Continued

Symptom	Possible Solution(s)
Operator will not run. Power LED is ON.	<ul style="list-style-type: none"> Press RESET button on BOTTOM of motor. Momentarily jumper terminal 6 to terminal 14. If input LED does not come ON, check terminal strip or replace control board. If LED does come on, go to the next step. <p>Remove circuit board from the terminal strip and shutoff power to the operator:</p> <ol style="list-style-type: none"> Momentarily jumper terminal 2 to terminal 3 (Caution – High Voltage). Momentarily turn power ON. The motor should run. Make sure power is OFF. Remove the jumper. Momentarily jumper terminal 2 to terminal 4 (Caution – High Voltage). Momentarily turn power ON. The motor should run. Make sure power is OFF. Remove the jumper. <ul style="list-style-type: none"> If motor does not run in either or both steps above, bad motor, motor capacitor or wiring to motor.
Arm rotates up, but will not rotate down.	<ul style="list-style-type: none"> Check LEDs on terminals 6, 7 and 9. Any of these ON will hold the arm in the UP position. This indicates a shorted input. Check the LEDs on the loop detectors. Any ON will hold the arm in the UP position. Possible loop or loop detector problem. If auto timer is not used (SW1, switch 7 off), check to be sure SW1, switch 6 is in the ON position. This will cause terminal 6 to rotate the arm down when it is activated. Check to be sure SW1, switch 4 is ON. This will cause terminal 8 activation, then deactivation to rotate arm down.
Down input / down loop will not rotate arm to down position.	<ul style="list-style-type: none"> Check to be sure SW1, switch 4 is in the ON position. Down input must be activated, and then deactivated to cause arm to rotate down.
Loop detector LED is on continuously.	<ul style="list-style-type: none"> Activate the reset switch on the loop detector. Decrease loop detector sensitivity. Check loop wire for resistance to ground with meg-ohm meter. Should be 100 meg-ohms or higher. If less than 50 meg-ohms, replace loop wire. Be sure loop lead-in wire is twisted at least 6 turns per foot. Be sure all loop connections are soldered. Replace loop detector.
Loop detector LED never activates.	<ul style="list-style-type: none"> Increase loop detector sensitivity. Check continuity of loop wire. Should be 0 ohms. If continuity check indicates anything other than 0 ohms, check all connections. Replace loop wire. Move loop detector board to the other loop detector port on the control board, and then check loop operation. If loop detector still fails, replace loop board. If loop detector operates OK in the other loop port, replace control board.
Battery back-up system will not raise arm upon power outage.	<ul style="list-style-type: none"> Check that the back-up system toggle switch is in the ON position. Check to be sure that the 1473-010 battery back-up control board switch settings are set as described in SECTION 7. Check the batteries for proper voltage, replace if necessary. Replace the 1473-010 Back-up control board.
Operator has intermittent functionality problems that vary.	<ul style="list-style-type: none"> The main terminal #5 250 mA power has been exceeded. Check total amp draw of connected device(s).

9.4 Accessories Parts List

The following accessories are available for the 1603 barrier gate operator.

Plug-In Loop Detector - Plug directly into ports on circuit board simplifying wiring.

P/N 9410-010 - Single channel detector.

P/N 9409-010 - Two channel detector.

P/N 9411-010 - Single channel detector with aux relay. Controls arm lowering for vehicles but NOT for pedestrians.

P/N 9416-010 - Single channel low power draw detector

P/N 9415-010 - Dual channel low power draw detector

Loop Wire - XLPE insulation is available in 500 and 1000 foot rolls, available in Black, Blue and Red insulation.

Loop Sealant - P/N 2600-771 Asphalt, P/N 2600-772 Concrete

Meg Ohm Meter - Checks the integrity of ground loops. P/N 9401-045

Reverse Edge - Installs on the bottom of a **ROUND** aluminum arm **ONLY**.

P/N 8080-071 - 2-wire 6 ft.

P/N 8080-091 - 4-wire 6 ft.

Photo Cell - Prevents arm from lowering on vehicles or pedestrians.

DoorKing Model 8080-057 Retro-Reflective Photocell

Miller Edge Reflective-Guard Model RG

Miller Edge Prime-Guard Model PG

EMX Industries Model IRB-MON

EMX Industries Model IRB-RET

Omron Model E3K-R10K4

Seco-Larm Model E-936-S45RRGQ

Seco-Larm Model E-960-D90GQ

Time Clock - 7 clock, used to automatically open gate at pre-set time, fits inside operator.

P/N 2600-791 - 7 day clock

Surge Devices - Helps prevent circuit board failure caused by lightning strikes and power surges.

P/N 1879-080 - High Voltage

P/N 1878-010 - Low Voltage

Replacement Battery - Convenience open system. P/N 1801-009 (2 required)

Speed Bump - Prefabricated 6-foot speed bump reduces traffic speed through gate system. P/N 1610-150

115 VAC 3.3 Amp Heater Kit - Thermostatically controlled heater for cold environment.

Note: This heater **ONLY** kit only works with a 115 VAC Input power wire on the barrier gate operator. P/N 1601-092

115 VAC 3.3 Amp Heater with Fan Assembly Kit - Thermostatically controlled heater and fan for cold and hot environments.

For 115 VAC input power **ONLY**. P/N 1601-154

208/230 VAC Heater with Fan Assembly Kit - Thermostatically controlled heater and fan for cold environment.

Note: This heater kit only works when installing a High Voltage Kit with 208 or 230 VAC Input power wire on the barrier gate operator.

P/N 1601-197

460 VAC Heater with Fan Assembly Kit - Thermostatically controlled heater and fan for cold environment.

Note: This heater kit only works when installing a High Voltage Kit with 460 VAC Input power wire on the barrier gate operator. P/N 1601-198

Fan Kit - Thermostatically controlled fan for hot humid environments. P/N 1601-093

Manual Gate Control Toggle - Allows user to manually operate gate arm. Fits inside single-gang electrical box. P/N 1200-017

Interconnection Cable - Interconnection cable contains all the necessary wires to interconnect primary / secondary operators.

Cable length: 30 ft. - P/N 2600-755 40 ft. - P/N 2600-756 50 ft. - P/N 2600-757

High Voltage Kit - Alter the input AC voltage on a 115 VAC 1603 to 208, 230, 460 or 575 VAC. P/N 2600-266

Gate Tracker™ - Optional control board allows the barrier gate operator to report activity to a companion 1833, 1835, 1837 or 1838 access control system.

Auto Spike System Parts

Operator Extension Section - 1.5 Ft torsion shaft, tunnel plate and ramp. P/N 1603-168

Extension Section - 1.5 Ft extension shaft, tunnel plate and ramp. P/N 1603-170

Spike Section - 3 Ft spike shaft, tunnel plate and ramp. P/N 1603-165

End Cap - P/N 1610-240

Lighted Auto Spike Warning Sign - Backlit spike warning sign with adjustable light for spike illumination. P/N 1615-081 - Auto Spikes

LED Traffic Light (Red, Green) - Manage the traffic flow with LED red-green lights. Bolts onto the 1601 or 1602 operator.

P/N 1603-221 - 6 Ft Cable with NO Post

P/N 1603-222 - 6 Ft Cable with 35" Post

P/N 1603-223 - 11 Ft Cable with 95" Post

Part numbers for 1603 arm kit "Options" are on the 1603 Specifications page.

1/2 HP 115 VAC

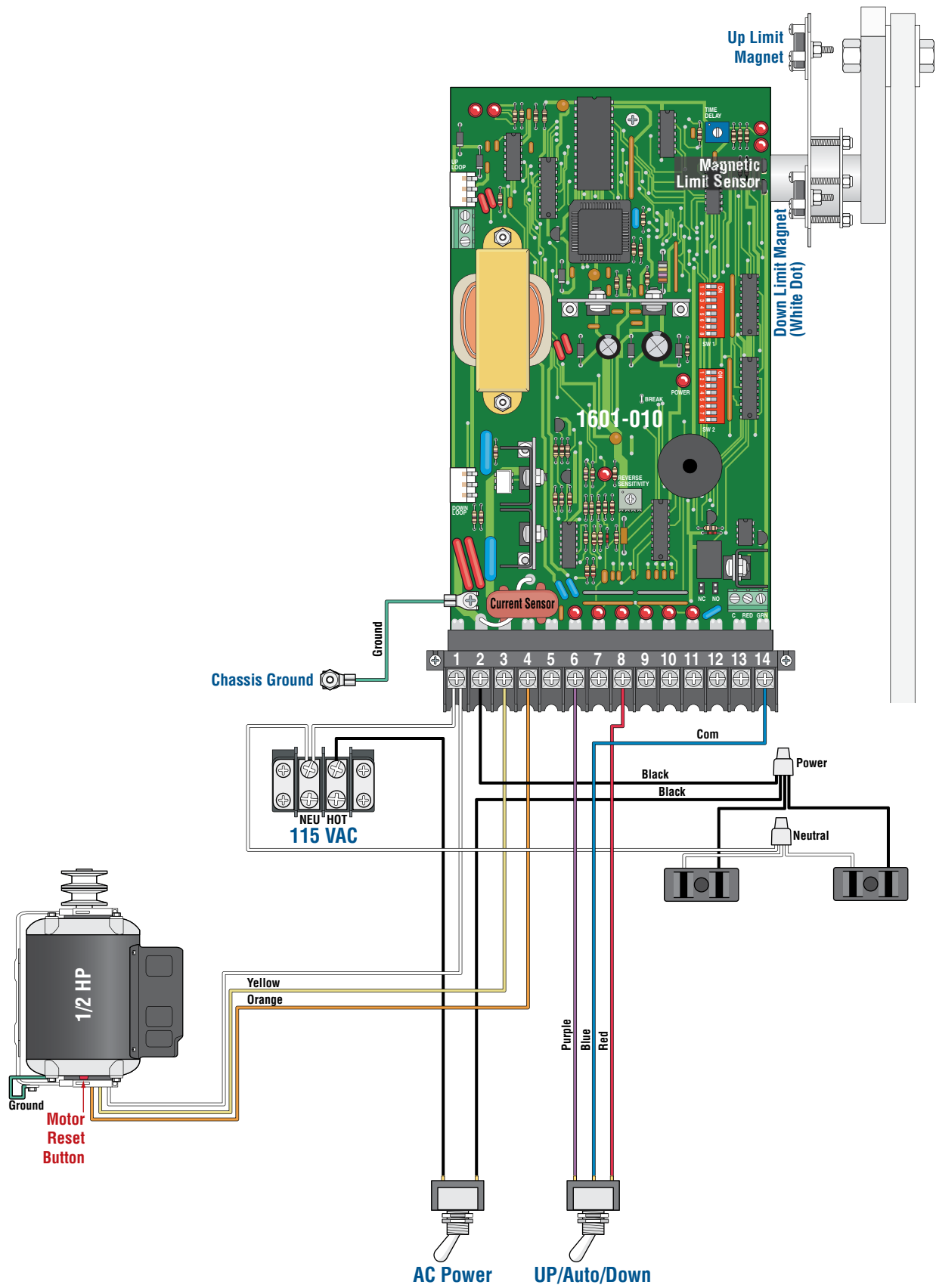

1/2 HP 115 VAC / Convenience Open

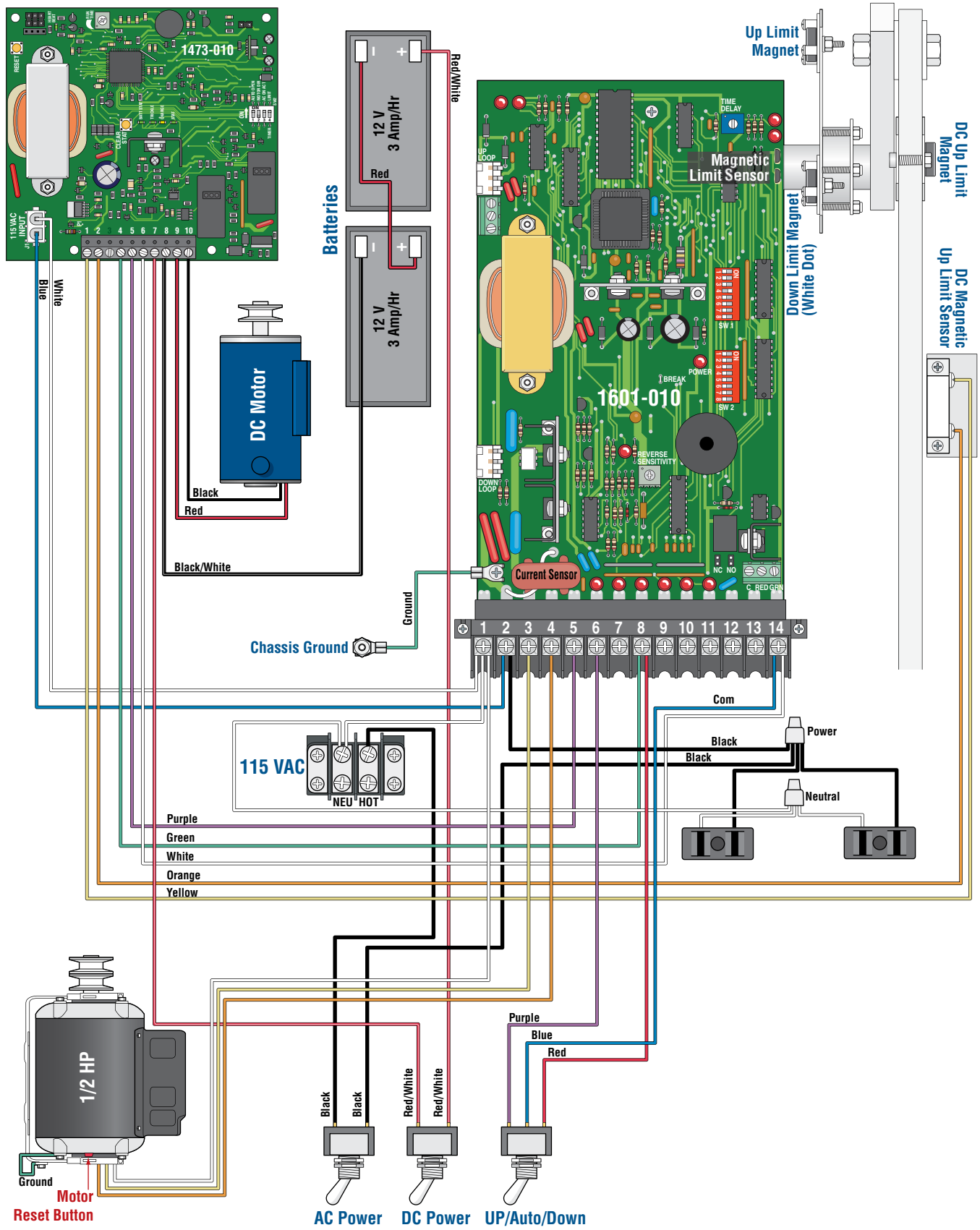

Installation/Owner's Manual

1603

Barrier Gate Operator with Auto Spike System

Use this manual for circuit board 1601-010 Revision AK or higher.

1603-065-P-10-24

THIS PRODUCT IS TO BE INSTALLED AND SERVICED BY A TRAINED GATE SYSTEMS TECHNICIAN ONLY.
Visit www.dkslocator.com to find a professional installing and servicing dealer in your area.



www.doorking.com

DoorKing, Inc.
120 S. Glasgow Avenue
Inglewood, California 90301
U.S.A.

Phone: 310-645-0023
Fax: 310-641-1586